



TOOLS & EQUIPMENT

BENCHES, CHAIRS & BENCH ACCESSORIES

Jewellers Benches, Durston

Free delivery on items B49505, B49506, B49507 & B49508 when delivered to UK mainland! (please place your order selecting a carriage method as usual. The carriage charge will be refunded once the item has been despatched).

- Durston offer 4 different types of bench to cover all the needs of jewellers & hobbyists
- Constructed to the criteria demanded by professional jewellers
- Designed with features of the manufacturing/repair shop bench
- Robust durable construction
- For jewellers, engravers, hobbyists, technicians etc.
- *Free delivery (within UK mainland)
- For international delivery please contact us for a competitive quote (via our online support under "Products and stock - Stock quantity enquiries")
- All benches arrive part assembled, with full assembly achieved within 15 minutes (packaged bench will fit through a standard size door)
- All benches are delivered on a pallet, please see the video link above for full delivery details
- Durston
- Made in UK

See "more info" for individual specification

Student Workbench (Free Delivery*)



- Affordable, robust jewellers bench
- Worktop has side and back rails to prevent items rolling off
- Curved cut out to get close to your work piece
- Has two wooden arm supports
- Has two holes either side of bench peg for mandrels (triblets)
- Supplied with bench peg
- Supplied with tool holder on the side
- Made from Eco friendly hardwood, strong and stable
- Arrives part assembled, full assembly in 5 minutes
- Packaged bench will fit through a standard size door
- Durston 1199B

Dimensions:

- 93 x 59 x 95cm overall size
- Worktop thickness 4cm
- Worktop height from floor 92cm
- Leg size 4.8 x 4.8cm
- Weight 23Kg

Free delivery to UK Mainland only. For international delivery please contact us for a competitive quote (via our online support under "Products and stock - Stock quantity enquiries")

Code	Description	UOM	Price
B49505	Student Workbench (Free Delivery*)	EACH	£195.00

Professional Workbench (Free Delivery*)



- Perfect addition to a jewellery workshop
- 3 side draws
- Slide out curved centre catch tray
- Large centre draw with steel base
- Worktop has side and back rails to prevent items rolling off
- Curved cut out in main work top to get close to your work piece
- Has two wooden arm supports
- Has two holes either side of bench peg for mandrels (triblets)
- Supplied with bench peg
- Made from Eco friendly hardwood, strong and stable
- Arrives part assembled, full assembly in 10 minutes
- Packaged bench will fit through a standard size door
- Durston 1820

Dimensions:

- 94.5 x 47.5 x 95.5cm overall size
- Worktop thickness 2cm
- Worktop height from floor 92cm
- Leg size 4.8 x 4.8cm
- Weight 42Kg

Free delivery to UK Mainland only. For international delivery please contact us for a competitive quote (via our online support under "Products and stock - Stock quantity enquiries")

Code	Description	UOM	Price
B49506	Professional Workbench (Free Delivery*)	EACH	£345.00



Superior Bench, Hardwood (Free Delivery*)



- The ultimate jewellers bench from Durston
- 6 side draws, 2 different sizes
- Slide out curved centre catch tray with steel base
- Extra small centre draw for most popular tools
- Extra pull out soldering board work surface
- Worktop has side and back rails to prevent items rolling off
- Curved cut out to get close to your work piece
- Has two wooden arm supports
- Has two holes either side of bench peg for mandrels (triblets)
- Supplied with bench peg
- Oak worktop
- Solid, premium hardwood construction. Heavy duty and robust
- Unique foot rest
- Arrives part assembled, full assembly in 15 minutes
- Packaged bench will fit through a standard size door
- Durston 1197B

Dimensions:

- 124 x 61 x 101cm overall size
- Worktop thickness 4cm
- Worktop height from floor 96cm
- Leg size 5.5 x 5.5cm

Free delivery to UK Mainland only. For international delivery please contact us for a competitive quote (via our online support under "Products and stock - Stock quantity enquiries")

Code	Description	UOM	Price
B49507	Superior Bench, Hardwood (Free Delivery*)	EACH	£625.00

Superior Bench, Oak (Free Delivery*)



- The ultimate jewellers bench from Durston
- 6 side draws, 2 different sizes
- Slide out curved centre catch tray with steel base
- Extra small centre draw for most popular tools
- Extra pull out soldering board work surface

- Worktop has side and back rails to prevent items rolling off
- Curved cut out to get close to your work piece
- Has two wooden arm supports
- Has two holes either side of bench peg for mandrels (triblets)
- Supplied with bench peg
- Solid oak construction. Heavy duty and robust
- Unique foot rest
- Arrives part assembled, full assembly in 15 minutes
- Packaged bench will fit through a standard size door
- Durston 1197

Dimensions:

- 124 x 61 x 101cm overall size
- Worktop thickness 4cm
- Worktop height from floor 96cm
- Leg size 5.5 x 5.5cm
- Weight 91Kg

Free delivery to UK Mainland only. For international delivery please contact us for a competitive quote (via our online support under "Products and stock - Stock quantity enquiries")

Code	Description	UOM	Price
B49508	Superior Bench, Oak (Free Delivery*)	EACH	£675.00

**Jewellers Benches,
Made in Italy**

Free Delivery!

Items B42392, B42393, B42394 & B4834 price includes delivery to UK mainland, (please supply your order selecting a carriage method as usual. The carriage charge will be removed & refunded once the order is placed)

- Constructed to the criteria demanded by professional jewellers
- Designed with features of the manufacturing/repair shop bench
- Robust durable construction
- For jewellers, engravers, hobbyists, technicians etc.
- Free delivery
- All benches are delivered on a pallet, please see the video link above for full delivery details
- We shall contact you after placing the order to arrange a specific delivery date
- Made in Italy

Italian Benches:

- Bench frame of solid, real beechwood
- 40mm thick table top
- Table top of study composite multi layer material, covered in a final layer of laminate
- Equipped with removable recovery/storage draw made of steel
- Steel lined compartment complete with fibre ceramic plate for soldering equipment storage
- Supplied with beechwood bench peg
- See "more info" for individual dimensions

**Jewellers Bench, Folding (Free Delivery)
Made in UK**



- Very robust with folding legs for easy mobility and storage.
- Dimensions: 84 x 91.5 x 61cm (HxLxD)
- Depth from back board to top of arch: 14" / 36cm

Code	Description	UOM	Price
B4195	Jewellers Bench, Folding (Free Delivery)	EACH	£325.00

Jewellers Bench, Italian (Free Delivery)



Price includes delivery to UK mainland!

- Overall Dimensions: 96 x 93 x 60cm (height x length x depth)
- Dimensions of arch cut out: 64 x 13cm (length x depth)
- 4cm thick table top
- Laminated worktop
- High quality beech wood frame
- Equipped with removable recovery/storage draw made of steel
- Steel lined compartment complete with fibre ceramic plate for soldering equipment storage
- Supplied with beechwood bench peg
- Weight 50Kg
- To order item, delivery time usually 5 weeks (8 weeks if order is placed in August or December)
- Delivered direct from Factory
- Made in Italy

Code	Description	UOM	Price
B42392	Jewellers Bench, Italian (Free Delivery)	EACH	£495.00



Jewellers Bench, Italian with Wooden Top (Free Delivery)



Price includes delivery to UK mainland!

- Overall Dimensions: 96 x 93 x 60cm (height x length x depth)
- Dimensions of arch cut out: 64 x 13cm (length x depth)
- 4cm thick table top
- Solid wood worktop
- High quality beech wood frame
- Equipped with removable recovery/storage draw made of steel
- Steel lined compartment complete with fibre ceramic plate for soldering equipment storage
- Supplied with beechwood bench peg
- Weight 50Kg
- To order item, delivery time usually 5 weeks (8 weeks if order is placed in August or December)
- Delivered direct from Factory
- Made in Italy

Code	Description	UOM	Price
B42394	Jewellers Bench, Italian with Wooden Top (Free Delivery)	EACH	£595.00

Jewellers Bench, Italian, 3 Draw (Free Delivery)



Price includes delivery to UK mainland!

- Overall Dimensions: 96 x 120 x 60cm (height x length x depth)
- Dimensions of arch cut out: 64 x 13cm (length x depth)
- 4cm thick table top
- Laminated worktop
- High quality beech wood frame
- Equipped with removable recovery/storage draw made of steel
- Steel lined compartment complete with fibre ceramic plate for soldering equipment storage
- Supplied with beechwood bench peg
- 3 extra storage draws
- Weight 75Kg
- To order item, delivery time usually 5 weeks (8 weeks if order is placed in August or December)
- Delivered direct from Factory

**FREE
CARRIAGE
ON BENCHES
TO UK
MAINLAND**

- Made in Italy

Code	Description	UOM	Price
B42393	Jewellers Bench, Italian, 3 Draw (Free Delivery)	EACH	£695.00

Jewellers Bench, Italian, 8 Draw (Free Delivery)



Price includes delivery to UK mainland!

- Overall Dimensions: 96 x 120 x 60cm (height x length x depth)
- Dimensions of arch cut out: 64 x 13cm (length x depth)
- 4cm thick table top
- Laminated worktop
- High quality beech wood frame
- Equipped with removable recovery/storage draw made of steel
- Steel lined compartment complete with fibre ceramic plate for soldering equipment storage
- Supplied with beechwood bench peg
- 8 extra storage draws
- Weight 85Kg
- To order item, delivery time usually 5 weeks (8 weeks if order is placed in August or December)
- Delivered direct from Factory
- Made in Italy

Code	Description	UOM	Price
B4834	Jewellers Bench, Italian, 8 Draw (Free Delivery)	EACH	£795.00

Setters Benches, Made in Italy

Free Delivery!

Items B42395 & B42396 price includes delivery to UK mainland! (please place your order selecting a carriage method as usual. The carriage charge will be removed & refunded once the order is placed)

- Benches specially designed for stone setters
- Constructed to the criteria demanded by professional jewellers
- Designed with features of the manufacturing/repair shop bench
- Robust durable construction
- Free delivery
- All benches are delivered on a pallet, please see the video link above for full delivery details
- We shall contact you after placing the order to arrange a specific delivery date
- Made in Italy

Features:

- Bench frame of solid, real beechwood
- 40mm thick table top
- Table top covered in a strong, resistant material with a matt finish
- 40 x 40cm working hole with an adjustable depth
- Supplied with 3 tier tool/setting/mould stand attached to bench

- See "more info" for individual dimensions

Setters Bench (Free Delivery)



Price includes delivery to UK mainland!

- Overall Dimensions: 103 x 90 x 60cm (height x length x depth)
- Dimensions of working hole: 40 x 40cm (length x width)
- 4cm thick table top
- Table top covered in a strong, resistant material with a matt finish
- High quality beech wood frame
- Supplied with 3 tier tool/setting/mould stand attached to bench
- Weight 55Kg
- To order item, delivery time usually 5 weeks (8 weeks if order is placed in August or December)
- Delivered direct from Factory
- Made in Italy

Code	Description	UOM	Price
B42395	Setters Bench (Free Delivery)	EACH	£815.00

Setters Bench, 3 Draws (Free Delivery)



Price includes delivery to UK mainland!

- Overall Dimensions: 103 x 126 x 60cm (height x length x depth)
- Dimensions of working hole: 40 x 40cm (length x width)
- 4cm thick table top
- Table top covered in a strong, resistant material with a matt finish
- High quality beech wood frame
- Supplied with 3 tier tool/setting/mould stand attached to bench
- 3 extra storage draws with additional open cabinet space
- Weight 70Kg
- To order item, delivery time usually 5 weeks (8 weeks if order is placed in August or December)
- Delivered direct from Factory
- Made in Italy

Code	Description	UOM	Price
B42396	Setters Bench, 3 Draws (Free Delivery)	EACH	£1,100.00

Watchmakers Benches, Durston

Free Delivery on item B49721 when delivered to UK mainland! (please place your order selecting a carriage method as usual. The carriage charge will be refunded once the item has been despatched).

- Durston offer 2 different types of bench to

cover all the needs of the horologist

- Constructed to the criteria demanded by professional horologists
- Solid timber top & frame
- Laminated, green table top
- Table top material is anti-static, soft yet firm and produces a no bounce effect for small items
- Supplied with extra pull out table top above the draws
- Safety rail all the way around the top preventing items from rolling off
- 2 moulded arm rests
- Foot rest
- 5 or 9 draw option
- *Free delivery (within UK mainland)
- For international delivery please contact us for a competitive quote (via our online support under "Products and stock - Stock quantity enquiries")
- All benches arrive part assembled, with full assembly achieved within 15 minutes (packaged bench will fit through a standard size door)
- All benches are delivered on a pallet, please see the video link above for full delivery details
- Durston
- Made in UK

See "more info" for individual specification

Watchmakers Bench, 5 Draw



- Affordable, robust watchmakers bench
- Solid timber top & frame
- Laminated, green table top
- Has two moulded arm supports
- 4 side draws & 1 centre draw
- Large lockable storage cabinet underneath the draws
- Supplied with extra pull out table top above the draws
- Arrives part assembled, full assembly in 15 minutes
- Packaged bench will fit through a standard size door
- Durston

Dimensions:

- 121 x 60 x 97cm overall size
- Worktop thickness 4cm

For international delivery please contact us for a competitive quote (via our online support under "Products and stock - Stock quantity enquiries")

Code	Description	UOM	Price
B49720	Watchmakers Bench, 5 Draw	EACH	£495.00



ORDER tracking

Watchmakers Bench, 9 Draw (Free Delivery*)



- Professional robust watchmakers bench
- Solid timber top & frame
- Laminated, green table top
- Has two moulded arm supports
- 8 side draws & 1 centre draw
- 2 Large lockable storage cabinets underneath the draws
- Supplied with extra pull out table top above each set of draws
- Arrives part assembled, full assembly in 15 minutes
- Packaged bench will fit through a standard size door
- Durston

Dimensions:
 • 131 x 75 x 97cm overall size
 • Worktop thickness 4cm

Free delivery to UK Mainland only. For international delivery please contact us for a competitive quote (via our online support under "Products and stock - Stock quantity enquiries")

Code	Description	UOM	Price
B49721	Watchmakers Bench, 9 Draw (Free Delivery*)	EACH	£795.00

Watchmakers Benches, Made in Italy

Free Delivery!

Items B9466, B42397 & B42398 price includes delivery to UK mainland! (please place your order selecting a carriage method as usual. The carriage charge will be removed & refunded once the order is placed)

- Constructed to the criteria demanded by professional watchmakers/repairers
- Designed with features of the manufacturing/repair shop bench
- Robust durable construction
- For watch makers, technicians, repairers, professionals
- Free delivery
- All benches are delivered on a pallet, please see the video link above for full delivery details
- We shall contact you after placing the order to arrange a specific delivery date
- Made in Italy

Features:

- Bench frame of solid, real beechwood
- 40mm thick table top
- Table top of study composite multi layer material, covered in a final layer of laminate
- Routed along the edges in real beechwood, height 10mm (approx.)
- Upholstered padded arm rests with 7 adjustable heights
- Equipped with removable recovery/storage draw made of steel

• See "more info" for individual dimensions

Watchmakers Bench, 4 Draw (Free Delivery)



Price includes delivery to UK mainland!

- Overall Dimensions: 105 x 130 x 80cm (height x length x depth)
- High quality beech wood frame
- 4cm thick table top
- Table top of study composite multi layer material, covered in a final layer of laminate
- Routed along the edges in real beechwood, height 10mm (approx.)
- Upholstered padded arm rests with 7 adjustable heights
- 4 extra storage draws on wooden slides
- Storage cupboard
- Weight 60Kg
- To order item, delivery time usually 5 weeks (8 weeks if order is placed in August or December)
- Delivered direct from Factory
- Black armrests
- Made in Italy

Code	Description	UOM	Price
B9466	Watchmakers Bench, 4 Draw (Free Delivery)	EACH	£760.00

Watchmakers Bench, 4 Draw, Brown Armrests (Free Delivery)



Price includes delivery to UK mainland!

- Overall Dimensions: 105 x 130 x 80cm (height x length x depth)
- High quality beech wood frame
- 4cm thick table top
- Table top of study composite multi layer material, covered in a final layer of laminate
- Routed along the edges in real beechwood, height 10mm (approx.)
- Upholstered padded arm rests with 7 adjustable heights
- 4 extra storage draws on wooden slides
- Storage cupboard
- Weight 60Kg
- To order item, delivery time usually 5 weeks (8 weeks if order is placed in August or December)
- Delivered direct from Factory
- Brown armrests

• Made in Italy

Code	Description	UOM	Price
B50867	Watchmakers Bench, 4 Draw, Brown Armrests (Free Delivery)	EACH	£760.00

Watchmakers Bench, 4 Draw, Beige Armrests (Free Delivery)



Price includes delivery to UK mainland!

- Overall Dimensions: 105 x 130 x 80cm (height x length x depth)
- High quality beech wood frame
- 4cm thick table top
- Table top of study composite multi layer material, covered in a final layer of laminate
- Routed along the edges in real beechwood, height 10mm (approx.)
- Upholstered padded arm rests with 7 adjustable heights
- 4 extra storage draws on wooden slides
- Storage cupboard
- Weight 60Kg
- To order item, delivery time usually 5 weeks (8 weeks if order is placed in August or December)
- Delivered direct from Factory
- Beige armrests
- Made in Italy

Code	Description	UOM	Price
B50868	Watchmakers Bench, 4 Draw, Beige Armrests (Free Delivery)	EACH	£760.00

Watchmakers Bench, 8 Draw (Free Delivery)



Price includes delivery to UK mainland!

- Overall Dimensions: 96 x 120 x 60cm (height x length x depth)
- High quality beech wood frame
- 4cm thick table top
- Table top of study composite multi layer material, covered in a final layer of laminate, wood effect
- Routed along the edges in real beechwood, height 10mm (approx.)
- Half round groove along the front edge, prevents items from rolling off
- Upholstered padded arm rests with 7 adjustable heights
- 8 extra storage draws on wooden slides
- Weight 60Kg

- To order item, delivery time usually 5 weeks (8 weeks if order is placed in August or December)
- Delivered direct from Factory
- Black armrests
- Made in Italy

Code	Description	UOM	Price
B42397	Watchmakers Bench, 8 Draw (Free Delivery)	EACH	£995.00

Watchmakers Bench, 8 Draw, Brown Armrests (Free Delivery)



Price includes delivery to UK mainland!

- Overall Dimensions: 96 x 120 x 60cm (height x length x depth)
- High quality beech wood frame
- 4cm thick table top
- Table top of study composite multi layer material, covered in a final layer of laminate, wood effect
- Routed along the edges in real beechwood, height 10mm (approx.)
- Half round groove along the front edge, prevents items from rolling off
- Upholstered padded arm rests with 7 adjustable heights
- 8 extra storage draws on wooden slides
- Weight 60Kg
- To order item, delivery time usually 5 weeks (8 weeks if order is placed in August or December)
- Delivered direct from Factory
- Brown armrests
- Made in Italy

Code	Description	UOM	Price
B50869	Watchmakers Bench, 8 Draw, Brown Armrests (Free Delivery)	EACH	£995.00

Watchmakers Bench, 8 Draw, Beige Armrests (Free Delivery)



Price includes delivery to UK mainland!

- Overall Dimensions: 96 x 120 x 60cm (height x length x depth)
- High quality beech wood frame
- 4cm thick table top
- Table top of study composite multi layer material, covered in a final layer of laminate, wood effect
- Routed along the edges in real beechwood, height 10mm (approx.)

- Half round groove along the front edge, prevents items from rolling off
- Upholstered padded arm rests with 7 adjustable heights
- 8 extra storage draws on wooden slides
- Weight 60Kg
- To order item, delivery time usually 5 weeks (8 weeks if order is placed in August or December)
- Delivered direct from Factory
- Beige armrests
- Made in Italy

Code	Description	UOM	Price
B50870	Watchmakers Bench, 8 Draw, Beige Armrests (Free Delivery)	EACH	£995.00

Watchmakers Bench, 10 Draw (On Metal Rails) (Free Delivery)



Price includes delivery to UK mainland!

- Overall Dimensions: 96 x 120 x 60cm (height x length x depth)
- High quality beech wood frame
- 4cm thick table top
- Table top of study composite multi layer material, covered in a final layer of laminate
- Routed along the edges in real beechwood, height 10mm (approx.)
- Half round groove along the front edge, prevents items from rolling off
- Upholstered padded arm rests with 7 adjustable heights
- 10 extra storage draws on metal slides
- Weight 75Kg
- To order item, delivery time usually 5 weeks (8 weeks if order is placed in August or December)
- Delivered direct from Factory
- Black armrests
- Made in Italy

Code	Description	UOM	Price
B42398	Watchmakers Bench, 10 Draw (On Metal Rails) (Free Delivery)	EACH	£1,875.00

Watchmakers Bench, 10 Draw (On Metal Rails), Brown Armrests (Free Delivery)



Price includes delivery to UK mainland!

- Overall Dimensions: 96 x 120 x 60cm (height x length x depth)
- High quality beech wood frame
- 4cm thick table top

- Table top of study composite multi layer material, covered in a final layer of laminate
- Routed along the edges in real beechwood, height 10mm (approx.)
- Half round groove along the front edge, prevents items from rolling off
- Upholstered padded arm rests with 7 adjustable heights
- 10 extra storage draws on metal slides
- Weight 75Kg
- To order item, delivery time usually 5 weeks (8 weeks if order is placed in August or December)
- Delivered direct from Factory
- Brown armrests
- Made in Italy

Code	Description	UOM	Price
B50871	Watchmakers Bench, 10 Draw (On Metal Rails), Brown Armrests (Free Delivery)	EACH	£1,875.00

Watchmakers Bench, 10 Draw (On Metal Rails), Beige Armrests (Free Delivery)



Price includes delivery to UK mainland!

- Overall Dimensions: 96 x 120 x 60cm (height x length x depth)
- High quality beech wood frame
- 4cm thick table top
- Table top of study composite multi layer material, covered in a final layer of laminate
- Routed along the edges in real beechwood, height 10mm (approx.)
- Half round groove along the front edge, prevents items from rolling off
- Upholstered padded arm rests with 7 adjustable heights
- 10 extra storage draws on metal slides
- Weight 75Kg
- To order item, delivery time usually 5 weeks (8 weeks if order is placed in August or December)
- Delivered direct from Factory
- Beige armrests
- Made in Italy

Code	Description	UOM	Price
B50872	Watchmakers Bench, 10 Draw (On Metal Rails), Beige Armrests (Free Delivery)	EACH	£1,875.00

Watchmakers Portable Bench, Horotec Swiss



Portable, mini bench

- High quality portable bench
- Fantastic for work on the go
- Great for small workshops where space is a premium
- Rests securely on any existing bench or table

- Solid oak wood with a varnished finish
- Supplied with two high quality, alcantara (similar to suede) covered padded armrests (detachable)
- Desk opens to reveal extensive storage space
- Additional draw at the front
- Both desk and draw lockable with supplied keys
- Horotec 24.071
- Made in Switzerland

Dimensions:

- Desk top: 40 x 40 x 13.5cm (width x length x height)
- Arm rests: 31.5 x 13 x 4.50cm (length x width x height)
- Total width with armrests extended: 79cm
- Weight: 8.3Kg
- See additional images for full dimensions specification

Code	Description	UOM	Price
B45571	Portable Bench, Horotec Swiss	EACH	£375.00

Watchmakers Portable Bench, Made in Italy



Portable, mini bench

- High quality portable bench
- Fantastic for work on the go
- Great for small workshops where space is a premium
- Rests securely on any existing bench or table
- Solid Beech wood with a varnished finish
- Supplied with two sold beechwood armrests (detachable)
- High wooden ridge at back to prevent items rolling off
- Half round groove round the front to prevent items rolling off
- 5 Draws, 3 at the front and 1 either side
- Made in Italy

Dimensions:

- Desk top: 50 x 50 x 14cm (width x length x height)
- Arm rests: 23 x 21cm
- Total width with armrests extended: 75cm
- Main front draw: 8 x 21 x 8cm (D x W x H)
- Mini front draws: 7.5 x 8 x 3cm (D x W x H)
- Large side draws: 22 x 24 x 8cm (D x W x H)
- Weight: 9Kg

Code	Description	UOM	Price
B49277	Portable Bench, Made In Italy	EACH	£375.00

Bench Armrest Device, Bergeon Swiss



- Bergeon 7880S
- Armrests with height adjustment
- Fixation device suitable for all types of work surfaces

Fitting instructions:

- Frame fixes to bench by drilling screws into place
- Worktop is then secured either with glue or double sided tape

Code	Description	UOM	Price
B40140	Bench, Armrest Device, Bergeon 7880S	EACH	£1,225.00

Bench Armrests, Bergeon Swiss



Removable Armrests - Leather with Silicon - Bergeon Swiss

- A pair of removable armrests
- Ideal for benches that are not equipped with armrests
- Leather cover with silicon padding
- Ergonomic anti slip top & bottom
- Simply rest on your work bench
- Bergeon 7327
- 280 x 180 x 25mm

Code	Description	UOM	Price
R40480	Removable Arm Rests, Bergeon 7327	EACH	£81.95

Bench Pegs

A bench peg is a traditional mounter's tool to hold / rest tools and work during the making process.

CousinsUK has a large and varied range of bench pegs and holders for the all types of application. Jeweller, silversmith, arts, crafts, watchmaker or any other profession, you are sure to find what you need here!

Bench pegs can be modified (by sawing or filing) if required.

- Standard
- Rubber
- "T" type
- Fancy
- With anvil
- With metal holder
- With V slot
- With U slot

Dimensions: (Working Length x Width)

75mm x 34mm Rubber with Holder



This is an exceptional tool for resting your work on while you're filing, burnishing etc.

- Rubber block angled so you can rest your work on minimising the chance of slipping or marking your piece
- Cast iron body with 3 clamping screw holes (screws not supplied)

Rubber working block size: 75 x 34 x 18mm

Overall size: 125 x 60 x 25mm

Code	Description	UOM	Price
F34935	75mm x 34mm Rubber with Holder	EACH	£8.95

95mm x 55mm with Metal Holder



Bench Pin with metal holder, screws on to your own design work surface

- Money saving idea to help make a sturdy bench peg for all your workshop bench
- For the jeweller, silversmith, arts craft and contemporary jewellers
- Easy fit bench peg kit.
- Screw the Bench Pin onto a side of a work surface so you have a bench peg to work on
- Easy wing nut adjustment to remove and fit bench pegs of your choice
- Sturdy cast iron body and wooden peg.

300grams

B19157 Bench Peg, 100mm x 55mm is the replacement bench peg for metal holder B31881

Code	Description	UOM	Price
B31881	95mm x 55mm with Metal Holder	EACH	£8.95

100mm x 55mm



- Overall Length 140mm
- Suitable for metal bench peg holder B31881

Code	Description	UOM	Price
B19157	100mm x 55mm	EACH	£2.50

110mm x 43mm



- Replacement for anvil combination (A4850)
- Peg size approx: 110 x 43 x 24mm

Code	Description	UOM	Price
B6110	110mm x 43mm	EACH	£2.50

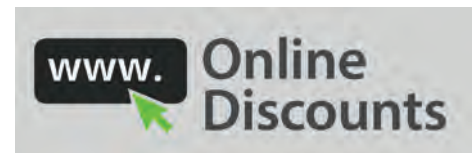

110mm x 43mm with Anvil



Are you a hobbyist, student, model maker or outwork jeweller and haven't got room for a jeweller's bench? This is an ideal tool to clamp on your work surface and have a bench peg to do your work on.

- Steel construction
- Easy adjusting clamping on/off clamp action
- Added planishing work surface (ideal for flattening your work pieces)

Size and weight:

- Peg size: 110 x 43 x 24mm (for replacement code B6110)
- Max clamping thickness size 40mm
- Overall size 180 x 120 x 65mm
- Planishing surface size 65 x 75mm
- Weight: 1.2kg

Code	Description	UOM	Price
A4850	110mm x 43mm with Anvil	EACH	£8.25

115mm x 45mm



• Overall Length 170mm

Code	Description	UOM	Price
B19158	115mm x 45mm	EACH	£2.50

115mm x 100mm StudioFLUX



- Overall Length 115mm
- Width 100mm
- Supplied with G clamp
- Holes with slots to file smaller items
- Half round and "V" shapes to aid filing
- Centre rear hole for clamp to secure to bench top
- Clamp fixing recessed for provide a flat working surface

Code	Description	UOM	Price
B46139	115mm x 100mm StudioFLUX	EACH	£10.95

120mm x 60mm



• Overall Length 160mm

Code	Description	UOM	Price
B4228	120mm x 60mm	EACH	£2.50

125 x 60mm, with Slot



• Overall Length 190mm

Code	Description	UOM	Price
S39262	125 x 60mm, with Slot	EACH	£2.50

125 x 60mm, with Slot & Clamp



- Overall Length 190mm
- Width 60mm
- Supplied with G clamp
- With slot

Code	Description	UOM	Price
B53970	125 x 60mm, with Slot & Clamp	EACH	£4.50

125 x 75mm with Spring Loaded with Leather Jaws



- Overall Length 175mm
- Width 75mm
- Spring loaded leather jaws to hold your work
- Perfect for sawing, filing & working
- Can be clamped into bench vice

Code	Description	UOM	Price
B53972	125 x 75mm with Spring Loaded with Leather Jaws	EACH	£6.95

135mm x 20mm, For Rings



• Overall Length 135mm

- Width 20mm narrowing to 10mm
- Can be clamped into bench vice
- Holes for screwing to desk

Code	Description	UOM	Price
S39263	135mm x 20mm, For Rings	EACH	£0.95

135 x 57mm, with V shape Cut Out



- Overall Length 135mm
- Width 57mm
- Slanted surface with "V" shaped cut out
- Cut out 35 x 25mm (length x widest point)

Code	Description	UOM	Price
B48602	135 x 57mm, with V shape Cut Out	EACH	£2.95

135mm x 57mm, with V Shape & U Shape Cut Outs



- Overall Length 135mm
- Width 57mm
- Slanted surface with "V" shaped cut out
- Cut out 35 x 25mm (length x widest point)
- Second "V" shape cut out on the side, 15 x 15mm (length x widest point)

Code	Description	UOM	Price
B48603	135mm x 57mm, with V Shape & U Shape Cut Outs	EACH	£2.95

140mm x 73mm



• Overall Length 180mm

Code	Description	UOM	Price
B19159	140mm x 73mm	EACH	£2.65

150mm x 55mm, T Type



- Overall Length 150mm
- Width 55mm
- Can be clamped into bench vice



- With two slanted surfaces and one flat surface

Code	Description	UOM	Price
P39596	150mm x 55mm, T Type	EACH	£3.50

158mm x 67mm, with U Shape Cut Out



- Overall Length 158mm
- Width 67mm
- Slanted surface with "U" shaped cut out
- Cut out 70 x 30mm (length x widest point)

Code	Description	UOM	Price
B48601	158mm x 67mm, with U Shape Cut Out	EACH	£2.95

150 x 125mm Fancy



- Overall Length 150mm
- Width 60mm
- Fancy style

Code	Description	UOM	Price
B53971	150 x 125mm Fancy	EACH	£8.25

210mm x 60mm Fancy, with Clamp



- Overall Length 210mm
- Width 60mm
- Supplied with G clamp
- Fancy style

Code	Description	UOM	Price
B38757	210mm x 60mm Fancy, with Clamp	EACH	£5.45

PRICE PROMISE GUARANTEE



Bench Peg & Forming Kit



Bench Peg - Ring Tribblet - Anvil - Oval Bracelet Mandrel

- Clamps to work desk, saving a lot of space
- Clamps your bench peg & any pegged mandrel in place
- Additional hole to clamp and hold ring tribblet

Kit contains:

- Bench peg:
 - 115 x 50mm
 - Wooden
- Ring Tribblet:
 - A to Z plus 1 to 6
 - 300mm overall length
 - Stainless Steel
- Oval Bracelet Mandrel:
 - Ø32 x Ø38mm to Ø56 x Ø61mm
 - Stainless Steel
- Anvil
 - 75 x 115mm

Code	Description	UOM	Price
B37637	Bench Peg & Forming kit	EACH	£35.95

Bench Tin (Jewellers)



Traditional Jewellers Bench Tins

A bench tin is placed under a Jeweller's Bench (code B4195). It is fitted by screwing five brackets with wood screws (not supplied) onto the base of the bench. The traditional bench tin is semi circular to fit densely against the semi circular shape of the bench's base.

Features of a Jeweller's Bench tin are:

- The tin's edge allows for storage of tools such as pliers, this bench still can store up to twenty pairs.
- Brush filings, scarp metals, polishing powders, residue and any left over from working, into the built in Lemel Tray. This is a holed, square metal piece that slides into the bottom of the bench tin at the middle. This catches any lemel that is swept into the bench tin, this is integral to use if you are working in precious metals. Regularly empty the lemel tray and store, cash in at a bullion dealer to refine the scarp. You will be surprised how much money or a bullion credit you can receive, particularly when then metal price is high.

Size and specification

- 620 x 240 x x 310mm (length x height x width)
- Length of Tool hanging brackets 200mm left and right side fitted
- Circumference of Bench Tin 910mm
- Five brackets at the top of bench tin, 200mm spaced

apart, diameter of wood screws needed 4mm to clamp on Jewellers Bench.

- Diameter of Lemel sieve 2cm
- Lemel tray size 90 x 75 x 20mm
- Black powder coated finish

Weight 5kg

Code	Description	UOM	Price
B32794	Bench Tin with Lemel Tray	EACH	£75.00

Chairs, Durston



- This superior jewellers/watchmakers chair has been specifically designed to give effective support to your back and thighs
- The high grade "faux" leather cover ensures durability as well as comfort and style
- Padded seat and arm rests
- Hardwood construction
- Seat has a flexible lift range, from 48 to 57cm
- Carries an 8 hour sit certification
- Has a "tilt and rock" feature or the position can be fixed
- 5 roller feet
- Hand made
- See video link above
- Durston 1862
- Made in UK

Dimensions:

- Overall height: 100cm
- Seat width: 60cm
- Back height: 50cm

Code	Description	UOM	Price
C49427	Chair, Durston	EACH	£164.95

Chairs, MPF

Free Delivery!

Items C48364 & C48366 price includes delivery to UK mainland! (please place your order selecting a carriage method as usual. The carriage charge will be removed & refunded once the order is placed)

- Constructed to the criteria demanded by professional watchmakers/repairers/jewellers
- Swivel professional chairs that are manufactured to the highest European standard
- Robust durable construction
- Beechwood or polyurethane seat
- Delivery is to kerbside
- We shall contact you after placing the order to arrange a specific delivery date
- Made in Italy

Features:

- 360 ° swivel chair
- Height adjustable, minimum seat height 42cm, maximum seat height 54cm (adjusted by hydrogas)
- 5 roller feet
- Overall width at feet 60cm
- See "more info" for individual dimensions



Beechwood Chair (Free Delivery)

Price includes delivery to UK mainland!

- Solid beechwood chair
- Seat dimensions: 42.5 x 41.5cm (depth x width)
- Back dimensions: 38 x 32cm (width x height)
- 5 roller feet
- Overall width at feet Ø60cm
- Made in Italy



Code	Description	UOM	Price
C48364	Beechwood Chair (Free Delivery)	EACH	£195.00

Polyurethane Chair (Free Delivery)

Price includes delivery to UK mainland!

- Soft polyurethane chair
- Seat dimensions: 46 x 43cm (depth x width)
- Back dimensions: 41 x 31cm (width x height)
- 5 roller feet
- Overall width at feet Ø60cm
- Made in Italy



Code	Description	UOM	Price
C48366	Polyurethane Chair (Free Delivery)	EACH	£225.00

Stools, MPF

Free Delivery!

Items C48365 & C48367 price includes delivery to UK mainland! (please place your order selecting a carriage method as usual. The carriage charge will be removed & refunded once the order is placed)

- Constructed to the criteria demanded by professional watchmakers/repairers/jewellers
- Swivel professional stools that are manufactured to the highest European standard
- Robust durable construction
- Beechwood or polyurethane seat
- Delivery is to kerbside
- We shall contact you after placing the order to arrange a specific delivery date
- Made in Italy

Features:

- 360° swivel chair
- Seat diameter: Ø35mm
- Height adjustable, minimum seat height 42cm, maximum seat height 54cm (adjusted by hydrogas)
- 5 Roller feet
- Overall width at feet Ø60cm

Beechwood Stool (Free Delivery)

Price includes delivery to UK mainland!

- Solid beechwood stool
- Seat diameter: Ø35mm
- Overall width at feet Ø60cm



Code	Description	UOM	Price
C48365	Beechwood Stool (Free Delivery)	EACH	£150.00

Polyurethane Stool (Free Delivery)

Price includes delivery to UK mainland!

- Soft polyurethane stool
- Seat dimensions: 35 x 35cm
- Overall width at feet Ø60cm



Code	Description	UOM	Price
C48367	Polyurethane Stool (Free Delivery)	EACH	£195.00

BENCH MATS



Work mats are a very handy addition to your work bench as using one will give you a clean, smooth and even surface for you to work on.

- Anti skid, anti static, flexible, plastic, rubber, ridged or extra thin all available
- A*F Swiss, Bergeon Swiss, Horotec Swiss or Cousins
- Adhesive or non adhesive backs
- Protects your work bench
- Helps prevent parts from being lost (there is less bounce off a softer work surface than a hard wooden bench)

Anti-Skid, Bergeon



Bergeon 7808 - Swiss Made

The same stability as an adhesive backed matt, with the flexibility of a normal mat. A choice of colours gives

the user the ability to pick which contrast suits his work best.

- Specialist anti-skid surface
- Slightly soft and flexible
- Black, green or white, offering different contrasts to suit the user
- Bergeon 7808
- 320 x 240 x 2mm

Code	Description	UOM	Price
M38989	Anti Skid Bench Mat, Black	EACH	£21.25
M38990	Anti Skid Bench Mat, Green	EACH	£21.25
M38988	Anti Skid Bench Mat, Black	EACH	£21.25

Anti-Skid, Horotec Extra Large



Horotec 24.216 - Swiss Made - 100 x 100cm

The same stability as an adhesive backed matt, with the flexibility of a normal mat. A choice of colours gives the user the ability to pick which contrast suits his work best.

- Specialist anti-skid surface
- Slightly soft and flexible
- Black or green, offering different contrasts to suit the user
- Extra large 100 x 100cm
- Can be cut to any shape or size you require
- 2mm thick
- Horotec 24.216 & 24.217

Code	Description	UOM	Price
M53179	Black 100 x 100cm Bench Mat	EACH	£125.00
M53180	Green 100 x 100cm Bench Mat	EACH	£125.00

Anti-Static, A&F & Cousins



Anti Static Bench Mats - Cousins or A*F Swiss

- Anti static mats
- A*F Swiss or Cousins
- Green
- 235 x 350mm

Code	Description	UOM	Price
M33334	235 x 350mm, A*F Swiss	EACH	£8.95
M35429	235 x 350mm, Cousins	EACH	£6.50
M35099	235 x 350mm, Cousins (adhesive backed)	EACH	£6.95



Flexi Mats, Bergeon



Flexi-Mats - Bergeon Swiss

- Black
- Excellent grip
- Soft & smooth
- Non adhesive back
- Easy to clean with a humid towel
- The material very close to Neopren
- Bergeon Smile line
- Bergeon 7050-8500-1 & 7050-8500-2

Code	Description	UOM	Price
M39297	295 x 180mm, Flexi-Mat	EACH	£11.50
M39298	600 x 370mm, Flexi-Mat	EACH	£18.15

Leather, Cushion Pad



Leather Finish - Cushion Pad

- 200 x 200 x 15mm
- Leather finish
- Excellent for movement holders, watch parts or tools
- Black

Code	Description	UOM	Price
M49626	200 x 200mm Watchmakers Pad	EACH	£9.95

Plastic (Original), Bergeon



Bergeon 6808 - Swiss Made

- Plastic bench mats
- With self adhesive backing
- Black, green or white, offering different contrasts to suit the user
- 240 x 320mm

Code	Description	UOM	Price
M45933	Black Plastic Mat, Bergeon Swiss	EACH	£9.95

M0964	Green Plastic Mat, Bergeon Swiss	EACH	£10.75
M45934	White Plastic Mat, Bergeon Swiss	EACH	£9.95

Plastic (Original), Horotec



New from Horotec, specialised super thin bench mats

- Super thin
- Inexpensive
- Sticky back without adhesive
- Great for those who prefer a harder surface
- Ideal for for apprentices, students or employees
- Flexible
- Can be glued to bench if required
- Black, green or white, offering different contrasts to suit the user
- 350 x 240 x 0.5mm
- Horotec Swiss 24.206

Code	Description	UOM	Price
M44133	Black Super Thin Mat, Horotec Swiss	EACH	£7.25
M44135	Green Super Thin Mat, Horotec Swiss	EACH	£7.25
M44134	White Super Thin Mat, Horotec Swiss	EACH	£7.25

Rubber (Original), Bergeon



Bergeon 5808 (&2746) - Swiss Made

- Rubber bench mats
- Bergeon 5808 (&2746)
- Black, Green or White
- Self-adhesive
- Sticks to any work bench
- Dimensions: 240 x 340 x 2.0mm

Code	Description	UOM	Price
M48097	Black Bench Mat	EACH	£30.75
M48096	Green Rubber Mat	EACH	£30.75
M48098	White Bench Mat	EACH	£30.75

Ridged Bench Mats

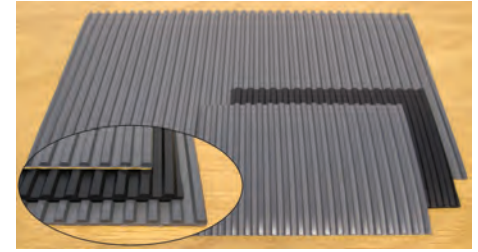

Bench Mats (Ridged)

- Adhesive Backed*
- Sticks to any work bench
- Stops tools rolling on the workbench

Code	Description	UOM	Price
M0966	100 x 150mm, Bergeon Swiss (Adhesive Back*)	EACH	£16.75
M54147	100 x 150mm, Horotec Swiss (Soft & Flexible)	EACH	£17.65
M53244	100 x 150mm, Indian	EACH	£3.95
M0965	180 x 300mm, Bergeon Swiss (Adhesive Back*)	EACH	£27.75
M54148	250 x 150mm, Horotec Swiss (Soft & Flexible)	EACH	£25.75
M35084	200 x 290mm, Indian	EACH	£5.95

BLOWERS & VACUUM PUMP

Dust Blowers are an essential tool when repairing or changing watch batteries and movements. By squeezing or pressing the dust blower natural air is recycled and blown into small areas to disperse dust particles from the watch. Always avoid blowing onto the movement yourself, this can deposit moisture into the watch and cause problems later.

There is always a chance fine particles or dust can get into the watch movement so it is always essential to use a Dust Blower. We have a large selection of Dust blowers comprised of various shapes and materials.

- Rubber blowers hold more natural air and when pressed will push out air faster with very little pressure.
- The Bakelite is finer and smaller for more accurate cleaning to enter awkward areas and clean.

Compressed Air, 5 Star

Dust Blower - Compressed Air

- Compressed Air Cleaner
- Made UK
- Supplied with special long nozzle for reaching parts normally inaccessible
- An ecological and ozone friendly product
- Contains no CFC or HCFC and is a none toxic, non carcinogenic and recyclable
- Contains: 400ml
- Weight: 350g



Compressed Air is an excellent medium to clean mechanical and quartz watches. Practically suitable for cleaning digital displays, dials, glasses and difficult to reach areas. It is also ideal for computers, optics, precision instruments, audio-visual and laboratories.



Instructions for use:

Hold vertically during use. Do not shake. Position the nozzle approximately 10cm from the object.

Code	Description	UOM	Price
A38766	Air Cleaner, Compressed Air	EACH	£3.95
Price breaks available, see website			

Blower (Hand) Bakelite, Bergeon



Dust Blower - Bergeon Swiss - Bakelite

- Bergeon 30540
- Will not roll around on your bench
- Ø35mm

Code	Description	UOM	Price
B0089	Bergeon Bakelite Dust Blower	EACH	£21.50

Blower (Hand) Rubber, A*F Swiss



Dust Blower - A*F Swiss

- A*F Swiss
- Sleeved nozzle
- Ø58 x 125mm overall

Code	Description	UOM	Price
B0088	A&F Rubber Dust Blower	EACH	£7.50

Blower (Hand) Rubber, Bergeon



Dust Blower - Bergeon Swiss

- Bergeon 4657
- Metal nozzle with plastic protection
- Length 100mm
- Ø58mm

Code	Description	UOM	Price
B0090	Bergeon Rubber Dust Blower Bergeon 4657	EACH	£7.75

Blower (Hand) Rubber, Bergeon



Dust Blower - Bergeon Swiss - Pear

- Bergeon 5733
- Pear shape
- Metal nozzle with plastic protection
- Length 100mm
- Ø60mm

Code	Description	UOM	Price
B0091	Bergeon Rubber Dust Blower Bergeon 5733	EACH	£8.75

Blower (Hand), Rubber E.U Made



Dust Blower - Made in E.U

- Metal nozzle
- Length 130mm
- Ø55mm
- Made in the E.U

Code	Description	UOM	Price
R38208	European Rubber Dust Blower	EACH	£4.50

Blower (Hand), Silicon Korea



Dust Blower - Made in Korea

- High quality dust blowers
- Soft silicon rubber
- Supplied with 2 different length nozzles
- Various colours available
- Length 130mm
- Ø60mm
- Made in Korea

Code	Description	UOM	Price
D55407	Black Dust Blower, Silicon	EACH	£7.95

D55411	Blue Dust Blower, Silicon	EACH	£7.95
D55412	Green Dust Blower, Silicon	EACH	£7.95
D55408	Orange Dust Blower, Silicon	EACH	£7.95
D55414	Pink Dust Blower, Silicon	EACH	£7.95
D55410	Turquoise Dust Blower, Silicon	EACH	£7.95
D55409	White Dust Blower, Silicon	EACH	£7.95
D55413	Yellow Dust Blower, Silicon	EACH	£7.95

Blower (Compressor) Pen, Bergeon Swiss



Dust Blowing Handpiece - Bergeon Swiss

- Handheld
- Ergonomic design
- To be used with a compressor or attached to an already existing pump network
- Air flow controlled with the push of a button
- With straight or 45 ° fitting
- Lightweight aluminium
- Takes a Ø6mm outer diameter tube
- Bergeon Swiss or unbranded
- Compressor connector C41895 will connect the pen to our Bambi compressors
- Brush connectors available, see our codes V45930, V45931 & V45932

Code	Description	UOM	Price
D55403	Dust Blower Pen	EACH	£22.95
B40225	Dust Blower Pen, Bergeon Swiss	EACH	£79.50
D55601	Dust Blower Pen with 45 ° Fitting	EACH	£22.95
B51704	Dust Blower Pen with 45 ° Fitting, Bergeon Swiss	EACH	£81.95
B40226	Connection tube for Pen to Compressor	2 METRES	£6.25

Vacuum (Hand) Pens

Vacuum Pens - Standard and Mini

Low-cost alternative to tweezers for the pickup and placement of delicate parts

- Pick up metal, plastic, surface mount resistors, or any other item having a smooth - nonporous surface that the rubber vacuum tip can seal against
- Extra soft silicone suction cups won't scratch or damage sensitive parts

How to use:

1. Install the suction header on suction pencil
2. Place the suction header level on component
3. Press down the button for the standard or press the body for the mini on the suction pencil to let out the air within the vacuum unit, then release the button to produce vacuum suction force to pick up part
4. Place the part on an appropriate place, press down the button/body, the vacuum unit discharges air to let the part fall off the suction header



Online Discounts



ORDER tracking

Ø12.3 x 155mm Manual Vacuum Pen



- 1 x Vacuum sucking soft comfortable rubber coated Pen 130mm
- 1 x Straight probe 30mm
- 1 x Bent probe 30mm
- 2 x 3mm suction head
- 2 x 7 mm Suction Headers
- 2 x 10 mm Suction Headers

Weight: 40 grams

Code	Description	UOM	Price
V33907	Ø12.3 x 155mm Manual Vacuum Pen	EACH	£14.95

Ø13 x 90mm Manual Vacuum Pen



- 1 x Vacuum sucking soft rubber Pen 75mm
- 3 x Bent probes suction head 7mm
- 3 x Straight probes suction head 3mm

Weight: 55 grams

Code	Description	UOM	Price
V33906	Ø13 x 90mm Manual Vacuum Pen	EACH	£12.95

Vacuum (Compressor) Pen, Bergeon Swiss



Vacuum Handpiece - Bergeon Swiss

- Handheld
- Ergonomic design
- To be used with a compressor or attached to an already existing pump network
- Air flow controlled with the push of a button
- With straight or 45 ° fitting
- Lightweight aluminium
- Compressor connector C41895 will connect the pen to our Bambi compressors

- Compressor connection lead is our reference B40226
- Brush connectors will also fit the Bergeon dust blower pen, our code B0225
- Bergeon 8809

Code	Description	UOM	Price
V51705	Vacuum Pen	EACH	£62.95
V45929	Vacuum Pen with 45 ° Fitting	EACH	£64.50
V45930	Very Soft Brush for Vacuum Pen	EACH	£14.35
V45931	Soft Brush for Vacuum Pen	EACH	£14.35
V45932	Coarse Brush for Vacuum Pen	EACH	£14.35

Vacuum Pump & Blower, Horotec Swiss



Vacuum Pump & Dust Blower - Horotec Swiss

Recommended by the top Swiss watch houses

- Double function of air pressure (blower) and vacuum
- 2 foot pedals give separate, easy operation of both the air pressure and vacuum functions
- Oil free engine
- Virtually noiseless
- Suitable for use in a white room
- With collection bowl
- Horotec 19.820

Technical information:

- 2300 litres per hour flow
- 80 mbar absolute empty value
- 1 bar pressure as standard (maximum available 2.8 bar)
- 290 x 200 x 220mm
- 9.4kg
- 220 volt
- CE marked

Kit contains:

- Double function air pressure & vacuum pump
- Vacuum pencil
- Blower pencil
- Soft brush for vacuum/blower pencil

Code	Description	UOM	Price
D51472	Vacuum & Dust Blower, Horotec 19.820	EACH	£2,750.00
B51997	Blower Pen, Horotec Swiss	EACH	£72.50
B51996	Vacuum Pen, Horotec Swiss	EACH	£66.95
B51998	Soft Brush, Horotec Swiss	EACH	£12.95
B51999	Hard Brush, Horotec Swiss	EACH	£12.95
B52000	Ø10mm PVC Tubing	3 METRES	£18.35



Vacuum Pump, A*F Swiss

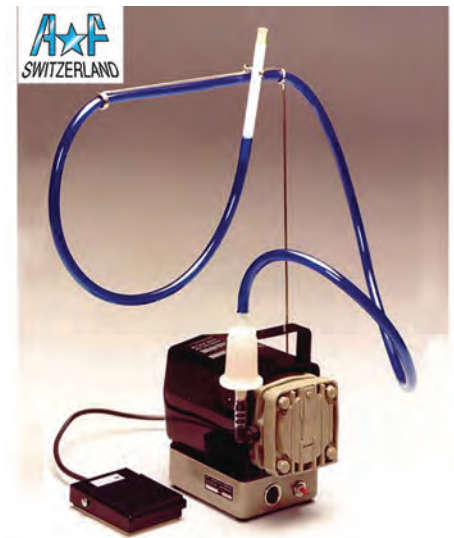

Vacuum Pump Dust Remover - A*F Swiss

- Suction debit: 1.2 cubic metres / hour
- Vacuum up to 150mbar
- Width 100 x Depth 170 x Height 165mm
- Weight: 4.3Kg
- 220 to 240 volt

Click website "More Information" for full specification.

Code	Description	UOM	Price
E19466	Dust Remover Vacuum Pump	EACH	£1,250.00
E20296	Dust Remover Vacuum Pump Spare Brush	EACH	£15.95

Vacuum Pump, Roxer Swiss

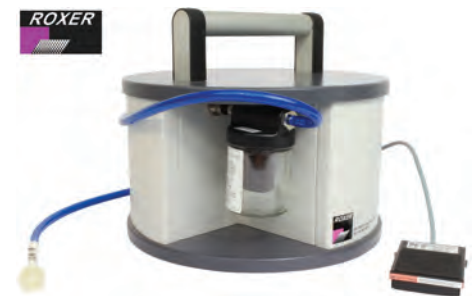

Vacuum Pump Dust Remover - Roxer

An Elite vacuum pump brought to you from Roxer Switzerland. This high class pump is at the top of the range in its field and its quality is evident.

- Available with one or two work stations
- Requires no servicing
- Long life span
- 230V

One complete unit contains:

- 1 Vacuum pump, suction at 4.1m³ per hour
- 1 inlet filter
- 1 foot switch (E37065)
- 1 vacuum pen (E37070)
- 1 vacuum pen stand (E37071)
- 2 RX14 white bristle brushes (E37067)
- 2 RX15 blue nylon brushes (E37069)
- 3 metres of tubing (E37072)

(Pump for two workstations comes with double the accessories mentioned above, except the pump and inlet filter)

- Dimensions:
- Ø310 x 262mm
 - 13.5Kg

Click website "More Information" & "PDF's" for full specification.

Code	Description	UOM	Price
E37063	Vacuum Pump, 1 Operator	EACH	£1,995.00
E37064	Vacuum Pump, 2 Operators	EACH	£2,250.00
E37066	Accessories Set for Vacuum pump	EACH	£134.50
E37069	Brushes, Blue Nylon	PACK*2	£19.35
E37067	Brushes, White Bristle	PACK*2	£19.35
E37065	Foot Switch for Vacuum Pump	EACH	£149.95
E37072	Tubing for Vacuum Pump	3 METRES	£13.25
E37070	Vacuum Pen	EACH	£44.95
E37071	Vacuum Pen Stand	EACH	£33.95

BOXES, CONTAINERS, JUGS, FUNNELS, STANDS AND TRAYS

ACID & FLUID BOTTLES

Acid & Fluid Glass Bottles

- Acid Testing Glass Bottles: Traditional acid bottles ideal for storing/testing your testing solutions either with dipping paddle or glass applicator.
- Glass Bottles with Corks: Perfect for storing beads or small objects and innocuous fluids.

Acid Bottle (Round) with Dipper

Round Acid Glass Bottle with Dipper

Has a sealable plastic lid incorporating a paddle applicator. Ideal for storing/testing your testing solutions.

- Ø22mm
- With Acid Proof Dipper

Code	Description	UOM	Price
A31884	Acid Bottle (Round) with Dipper	EACH	£1.50

Acid Bottle (Round) with Applicator

Round Acid Testing Glass Bottle

Completely made from glass with applicator included in the closing cap. Ideal for storing/testing your testing solutions

- Round acid bottle with dipper
- Weight 50gms
- Capacity 20ml
- Ø32mm

Code	Description	UOM	Price
S39266	Acid Bottle (Round) with Applicator	EACH	£1.25

Acid Bottle (Square) with Applicator

Square Acid Testing Glass Bottle

Completely made from glass with applicator included in the closing cap. Traditional acid bottle, ideal for storing/testing your testing solutions.

- Square acid bottle with dipper
- Weight 50gms
- Capacity 20ml
- 24 x 24mm

Code	Description	UOM	Price
B19163	Acid Bottle (Square) with Applicator	EACH	£1.50

Fluid Bottle with Cork (50 x Ø25mm)

Glass Bottles with Corks

Perfect for storing beads or small objects and innocuous fluids.

- Ø25 x 50mm

Code	Description	UOM	Price
B45694	Fluid Bottle with Cork (50 x Ø25mm)	EACH	£1.50

Fluid Bottle with Cork (75 x Ø25mm)

Glass Bottles with Corks

Perfect for storing beads or small objects and innocuous fluids.

- Ø25 x 75mm

Code	Description	UOM	Price
B45695	Fluid Bottle with Cork (75 x Ø25mm)	EACH	£1.75

ACID BOTTLE WOODEN BOXES

Sturdy acid testing bottle storage and transportation boxes allow you to test your precious metals anywhere or simply keep your desk tidy and safe.

2 Compartment (2 Acid Bottles Ø35mm)

- Holds 2 gold testing acid bottles
- Hole diameter Ø35mm



- 100 x 45 x 30mm

Code	Description	UOM	Price
S39267	2 Compartment (2 Acid Bottles Ø35mm)	EACH	£1.95

4 Compartment (3 Acid Bottles & Touchstone)

- Fill your acid testing solutions in this unit for safe storage and transportation
- Easy open and close magnetic lid
- Comes with three acid testing bottles complete with application paddle
- Gold testing touchstone included
- Compartments Ø23mm

Size: 110 x 65 x 70mm
Weight: 300g

Code	Description	UOM	Price
T36078	4 Compartment (3 Acid Bottles & Touchstone)	EACH	£12.50

5 Compartment (4 Acid Bottles & Touchstone)

- Fill your acid testing solutions in this unit for safe storage and transportation
- Easy open and close magnetic lid
- Comes with five acid testing bottles complete with application paddle
- Gold testing touchstone included
- Compartments Ø23mm

Size: 115 x 90 x 70mm
Weight: 450g

Code	Description	UOM	Price
T36077	5 Compartment (4 Acid Bottles & Touchstone)	EACH	£14.50

5 Compartment (Various)

Put your acid testing bottles and touch stone in this unit for safe storage and transportation.

- Easy open and close magnetic lid
- Dimensions: 95 x 70 x 100mm

Compartments:
• 27 x 27mm (8 compartments)
• 42 x 21mm (1 compartment)

Code	Description	UOM	Price
B22159	5 Compartment (Various)	EACH	£5.95

9 Compartment (Various)

Put your acid testing bottles and touch stone in this unit for safe storage and transportation.

- Easy open and close magnetic lid
- Dimensions: 195 x 90 x 100mm

Compartments:
• 33 x 33mm (8 compartments)



• 70 x 33mm (1 compartment)

Code	Description	UOM	Price
S39268	9 Compartment (Various)	EACH	£8.95

TOOL BOXES, RACKS & STANDS

Burr Box, Wooden



- Wooden burr boxes
- Hinge lid with magnet catch
- Multiple versions available
- Lacquered light, hard wood

Dimensions:

- Burr holes (overall length x width x height)

Code	Description	UOM	Price
B53976	12 Hole Burr Box (85 x 55 x 65mm)	EACH	£6.95
B53977	24 Hole Burr Box (95 x 80 x 55mm)	EACH	£7.95
B53978	72 Hole Burr Box (160 x 90 x 60mm)	EACH	£9.95
B9469	100 Hole Burr Box (145 x 145 x 60mm)	EACH	£10.95
B41171	200 Hole Burr Box (250 x 150 x 60mm)	EACH	£16.95

Burr Box, Wooden with Magnet



- Size: 125 x 75 x 60mm
- Lacquered light wood
- With magnet
- Holds burrs with Ø2.35mm shank

Code	Description	UOM	Price
B9470	Burr Box, 36 Hole	EACH	£6.95

Burr Stand, Acrylic

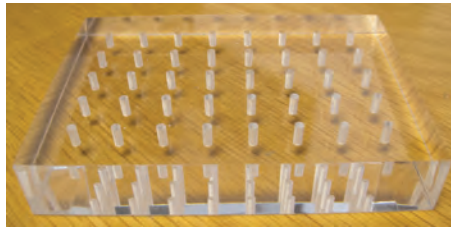

- Size: 110 x 75 x 20mm
- Clear acrylic material
- Capable of holding 40 burrs
- Holds burrs with Ø2.35mm shank

Code	Description	UOM	Price
B42905	40 Hole Acrylic Burr Stand	EACH	£6.95

Burr Stand, Acrylic (Tiered)

- 3 Tier
- Height 65mm
- Diameter 55mm
- Plastic
- Lid
- Holds burrs with Ø2.35mm shank



Code	Description	UOM	Price
B8681	Burr Stand 36 Holes, 3 Tier	EACH	£2.20

Burr Stand, Wooden



Multi purpose for burrs, drills, mini mops, buffs & brushes. Keep your bench tidy and tools easy to find and access.

- Size: 155 x 95 x 45mm (25mm lowest point)
- Weight: 300g

Code	Description	UOM	Price
S34936	Wooden Burr Stand, 88 Hole	EACH	£5.95

Burr Stand, Multi-Positional

Made in Indian

Small stand in plastic, ideal for holding and preventing loss or damage to burrs, drills, midget brushes etc. Keeps tools within easy reach of the jeweller.

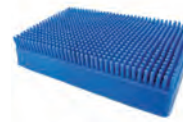

- Multi-positional synthetic base
- Spiked to hold shanks
- Size: 120 x 70 x 25mm

Code	Description	UOM	Price
S35086	Multi Burr Stand	EACH	£3.95

Multi-Positional Burr Stand, A*F Swiss

A*F Swiss

Small stand in plastic, ideal for holding and preventing loss or damage to burrs, drills, midget brushes etc. Keeps tools within easy reach of the jeweller.

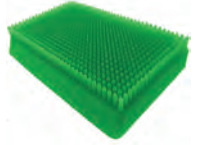

- Multi-positional synthetic base
- Spiked to hold shanks
- Size: 130 x 80 x 25mm

Code	Description	UOM	Price
S4269	Multi Burr Stand	EACH	£10.95

Burr Stand, Revolving (Magnetic)

- Can hold up to 40 burrs
- Height: 50mm
- Diameter: 60mm



Code	Description	UOM	Price
S34937	Magnetic Burr Rotary Stand	EACH	£4.95

Burr Stand, Revolving (Plastic)

Rotating stand with quality steel ball bearings. Ideal for for burrs & drills with a centre space for tools.



- 3 Tier
- Holds 114 burrs
- Ø170 x 105mm (diameter at base x height)
- Ø70mm x 70mm deep internal centre to hold tools
- Made in India

Code	Description	UOM	Price
B19400	Burr Stand, Revolving, 3 Tier	EACH	£8.95

Burr Stand, Revolving (Plastic), Freedom

Rotating stand with quality steel ball bearings. Ideal for for burrs & drills with a centre space for tools.



- 3 Tier
- Holds 114 burrs
- Ø170 x 105mm (diameter at base x height)
- Ø70mm x 75mm deep internal centre to hold tools
- Freedom FD10081
- Made in USA

Code	Description	UOM	Price
FD10081	Burr Stand, Made in USA	EACH	£14.95

OVER 130,000 DIFFERENT ITEMS

Burr Stand, Revolving (Wooden)

Rotating stand with quality steel ball bearings. Ideal for for burrs & drills with a centre space for tools.

- 6 sided
- Holds 336 burrs (multiple shank diameters)
- With 20 holes on the top for files, brushes etc (hole diameter Ø12mm)
- 185 x 260mm (width x height)
- Treated wood
- Made in India



Code	Description	UOM	Price
B52377	Burr Stand, Revolving, 6 Sided	EACH	£31.85

Repair Job Envelope Stand



Repair Job Envelope Stand

Organise your repair job envelopes with this simple and efficient stand. Made from sturdy clear plastic, it has 3 removable divisions, allowing you to create up to 4 compartments or just the size space you need.

- Clear plastic
- 3 removable separations
- 280 x 90 x 90mm (Height x width x depth)

Code	Description	UOM	Price
S39271	Repair Job Envelope Stand	EACH	£7.95

Saw (Piercing) Blade Stand

- Keeps your piercing saw blades organised and easy to access
- With markings for easy identification
- Swivel base
- Wooden
- Ø95mm base
- Overall height 120mm



Code	Description	UOM	Price
S47022	Saw Blade Stand, Piercing	EACH	£7.95

Tool Box Padlock

- Perfect for fitting with our tool box range
- 32mm
- Hardened Steel shackle
- Self locking action
- Brass body
- Supplied with 3 keys



Code	Description	UOM	Price
P33526	32mm Brass Padlock	EACH	£3.60

Tool Box Tidy



- For storing pliers, files, tweezers and hand tools
- Lacquered wood
- With draw
- Size: 190 x 165 x 100mm

Code	Description	UOM	Price
B9477	Tool Box Tidy	EACH	£12.95

Tool Box with Tray



Very convenient for storing or transporting tools when travelling to a customers premises etc.

Stanley Toolboxes

- Stanley:
- Robust metal latches
 - Soft grip handle that folds flat into box
 - Top cover compartment with 2 separate handy compartments
 - Removable tray inside
 - Built in padlock eye
 - Made in UK

Code	Description	UOM	Price
B8692	32cm Tool Box, Whitefurze (popular with students)	EACH	£6.95
T46050	41cm Tool Box, Stanley	EACH	£10.50
T46051	51cm Tool Box, Stanley	EACH	£11.95
T46052	65cm Tool Box, Stanley	EACH	£18.95

Tool Case (Pliers & Cutters)



Plier Case - Leather

- Leather plier case
- Holds 4 pliers
- Zip locked
- Great for transportation and storage
- 160 x 170mm

Code	Description	UOM	Price
P39499	Leather Case for Pliers	EACH	£4.95

Tool Rack Organiser



- Wooden tool rack organiser
- Sits on your workbench
- Exactly what you need to organise your workbench/ workshop
- Draws, racks, hanging stations, open storage bins and burr holes
- Steam beech finish

- 460 x 115 x 185mm (width x depth x height)

Features

- 4 draws
- 6 rack slots (top left)
- 48 holes for burrs & drills
- 2 racks for pliers & cutters
- 3 open spaces

Code	Description	UOM	Price
T45704	Tool Organiser	EACH	£29.95

Tool Rack Tidy



- Plier rack
- Burr stand
- File stand
- Sturdy yet lightweight acrylic
- 560g

Code	Description	UOM	Price
P41188	Tool Rack Tidy	EACH	£19.95



Tool Rack, Plastic (Pliers & Cutters)



Plier Rack - Plastic

- Very handy for organizing pliers on work bench
- Holds up to 12 pliers
- White Plastic
- Length 230mm
- Width 100mm
- Height 130mm

Code	Description	UOM	Price
P19162	Plastic Plier Rack	EACH	£5.50

Tool Rack, Plastic & Steel (Pliers & Cutters)



Plier Rack - Plastic & Steel

- Very handy for organizing pliers on work bench
- Plastic ends with steel rack
- 3 Point structure, hard to knock over
- New age, modern look

Dimensions:
 • Length 200mm
 • Width 85mm
 • Height 100mm

Code	Description	UOM	Price
P37129	Plier Rack	EACH	£7.95

Tool Rack, Wooden (Pliers & Cutters)



Plier Rack - Wooden

- Very handy for organizing pliers on work bench
- Holds up to 10 pliers
- Smooth wood
- Length 185mm
- Width 90mm
- Height 125mm

Code	Description	UOM	Price
P39501	Wooden Plier Rack	EACH	£5.95

Tool Rack, Wooden (Tweezers)



Tweezer Rack - Wooden

- Very handy for organizing tweezers on work bench
- Holds up to 10 tweezers
- Smooth wood

Dimensions:
 • TBA

Code	Description	UOM	Price
S55608	Tweezer Stand	EACH	£11.95

Tool Rack, Wooden (Wheels, Mops & Laps)



Wheel Rack - Wooden

- Very handy for organizing wheels, mops or split laps
- 6 slots
- Each slot can hold a wheel up to 20mm thick
- Smooth wood

Dimensions:
 • TBA

Code	Description	UOM	Price
T53987	Wheel, Mop & Lap Stand	EACH	£9.95

Tool Stand, Wooden (Pliers & Cutters)



Plier Stand - Wooden Base

- Hard wood varnished
- Keeps your work bench tidy
- Stores 6 or 3 pairs of pliers upright

P39500:

- 75 x 95 x 25mm
- Holes are 12mm apart
- Hole diameter Ø14mm

P7985:

- 75 x 160 x 25mm
- Holes are 33.50mm apart
- Hole diameter Ø14mm

Code	Description	UOM	Price
P39500	3 Pliers Stand	EACH	£2.50
P7985	6 Pliers Stand	EACH	£3.65

Tool Rack (Wall Mounted)



Wooden jewellery tool storage rack

This superb rack is a fantastic way to store your workshop tools. The ability to mount this item to the wall can not only save space in a busy workshop, but allows quick and easy access to all your tools.

- Simply secure on to your wall (screws and wall plugs not provided)
- Store up to ten hammers (depending on the size of the head)
- Space for up to nine average size triblets/ring sticks, stopping them from rolling loosely around your work area
- Located on the left hand side are two magnetic tool strips, ideal to attach your pliers, tweezers etc.
- Traditional dark brown finish

Dimensions: 460 x 170 x 165mm



- Wood thickness: 18mm (approx.)
- Ring stick holes: Ø21mm
- Magnetic tool holder strips: 160 & 140mm
- Weight: 1.8Kg

Code	Description	UOM	Price
S36086	Wall Mounted Tool Rack	EACH	£19.50

- Aluminium with see through glass lids
- Supplied in cardboard box
- Pack*12, pack*6 (B39611) or pack*24 (B39616)

Dimensions:

- Individual container diameter x height

Code	Description	UOM	Price
B39616	Ø20mm x 20mm Aluminium Tins	PACK*24	£3.95
B39615	Ø30mm x 15mm Aluminium Tins	PACK*12	£2.95
B39614	Ø35mm x 20mm Aluminium Tins	PACK*12	£2.95
B39613	Ø45mm x 20mm Aluminium Tins	PACK*12	£3.95
B39612	Ø55mm x 25mm Aluminium Tins	PACK*12	£3.95
B39611	Ø75mm x 25mm Aluminium Tins	PACK*6	£4.95

Aluminium Pots in Wooden Box



- Multiple, removable compartments
- Aluminium tubs
- Classy wooden storage & transportation box
- Inserts have removable, glass lids
- Magnetic lid
- See additional information for full specification

Code	Description	UOM	Price
B42961	18 Round Compartments, Multi Size	EACH	£12.75
B39619	18 x Ø45mm Round Compartments	EACH	£12.95
B39618	24 x Ø22mm Round Compartments	EACH	£7.95
B39617	36 x Ø22mm Round Compartments	EACH	£9.95

Compartment Boxes with Divides



- For spare parts, beads any small items
- Removable or hinged lid
- Plastic

Dimensions - overall size (compartment size):

- B47257: 130 x 70 x 20mm (25 x 30 x 20mm)
- B5593: 67 x 51 x 10mm (10 x 25 x 10mm)
- B8744: 110 x 65 x 14mm (10 x 30 x 14mm)
- B9831: 210 x 110 x 30mm (34 x 34 x 30mm)

Code	Description	UOM	Price
B47257	10 Compartments, 130 x 70 x 20mm	EACH	£1.50

B5593	12 Compartment Storage Box	EACH	£0.95
B8744	18 Compartment Storage Box	EACH	£1.25
B9831	18 Compartment Storage Box	EACH	£3.95

Price breaks available, see website

Compartment Boxes with Divides, Bergeon

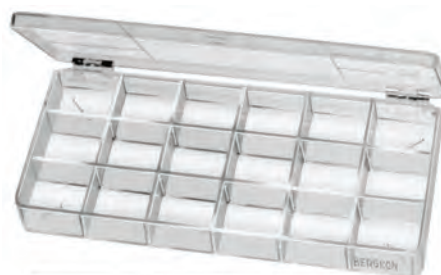

- Bergeon 2968
- Hinged Lid
- Clear Transparent Plastic
- 6 Different Compartment Configurations
- Outer dimensions: 195 (L) x 90 (W) x 21mm (D)

Code	Description	UOM	Price
B6677	1 Compartment Storage Box	EACH	£18.95
B0135	3 Compartment Storage Box	EACH	£18.95
B6678	6 Compartment Storage Box	EACH	£18.95
B0136	12 Compartment Storage Box	EACH	£18.95
B0137	18 Compartment Storage Box	EACH	£19.95
B0138	36 Compartment Storage Box	EACH	£19.95

Compartment Boxes with Divides, Round



- Five compartment trays
- Stackable
- Ideal for movements, dismantled and ready for repair
- Ø75mm

Code	Description	UOM	Price
P7986	5 Compartment Storage Box	EACH	£1.35

Price breaks available, see website

Compartment Boxes with Divides, Slide Lid

- For spare parts, beads any small/medium items
- Completely removable, clear plastic slide lid
- Plastic base

Dimensions - overall size (compartment size):

COMPARTMENT BOXES, POTS & TUBES

We have a great variety of storage and transportation boxes, catering to all your horological, jewellery and gemmology needs. From professional gemstone display cases to sturdy gold testing acid bottle storage, as well as safe and secure small parts compartment storage, you really don't need to look anywhere else!

The sizes displayed are only the overall sizes, many of our boxes are compartmentalised, either containing many small removable compartments, or have fixed or removable dividers. Drop down the headings to see our full range of products.

Aluminium Pots in Aluminium Box



- Multiple, removable compartments
- Inserts have removable, glass lids
- Aluminium inserts
- In aluminium case
- With foam in lid for noise reduction

Dimensions - overall size, (Insert size):

- B39609: 165 x 135 x 20mm, (Ø40 x 20mm)
- B39607: 165 x 135 x 20mm, (Ø30 x 17mm)
- B39608: 165 x 135 x 20mm, (Ø25 x 18mm)
- B39610: 165 x 110 x 20mm, (Ø15 x 20mm)

Code	Description	UOM	Price
B39609	12 Round Compartments, 165 x 135 x 20mm	EACH	£4.50
B39607	24 Round Compartments, 165 x 135 x 20mm	EACH	£4.50
B39608	20 Round Compartments, 165 x 135 x 20mm	EACH	£4.95
B39610	54 Round Compartments, 160 x 110 x 20mm	EACH	£8.75

Aluminium Pots in Cardboard Box



Handy storage containers to keep watch/pocket watch movements or jewellery casting wax models safe

- B39605: 190 x 145 x 20mm (Various)
- B47052: 190 x 100 x 20mm (30 x 30 x 15mm)
- B39606: 265 x 170 x 45mm (42 x 55 x 36mm)
- B39604: 195 x 125 x 20mm (30 x 30 x 15mm)
- B48656: 195 x 125 x 20mm (30 x 30 x 15mm)

11 Compartments, 190 x 145 x 20mm



- Overall size: 190 x 145 x 20mm
- Compartment size: Various
- Black

Code	Description	UOM	Price
B39605	11 Compartments, 190 x 145 x 20mm	EACH	£2.95

18 Compartments, 190 x 100 x 20mm



- Overall size: 190 x 100 x 20mm
- Compartment size: 30 x 30 x 15mm
- Black

Code	Description	UOM	Price
B47052	18 Compartments, 190 x 100 x 20mm	EACH	£2.95

18 Compartments, 265 x 170 x 45mm



- Overall size: 265 x 170 x 45mm
- Compartment size: 42 x 55 x 36mm
- Blue

Code	Description	UOM	Price
B39606	18 Compartments, 265 x 170 x 45mm	EACH	£5.95

24 Compartments, 195 x 125 x 20mm



- Overall size: 195 x 125 x 20mm
- Compartment size: 30 x 30 x 15mm
- Blue

Code	Description	UOM	Price
B39604	24 Compartments, 195 x 125 x 20mm	EACH	£2.95

18 Compartments, 190 x 100 x 20mm



- Overall size: 195 x 125 x 20mm
- Compartment size: 30 x 30 x 15mm
- White

Code	Description	UOM	Price
B48656	18 Compartments, 190 x 100 x 20mm	EACH	£2.95

Compartment Boxes with Divides, XL

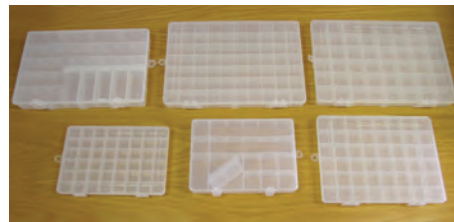

Working away in your in a busy workshop, retail, arts/craft, model making home environment there is nothing like been frustrated finding an item.

Our range of sturdy see through polyethylene compartment boxes provides easy storage of small components.

- Sturdy see-through polyethylene construction
- With click lock lid, integral hinges sealing the compartments to avoid spillage and cross section mixing.
- Our compartment boxes come in two type's fixed or flexible removable dividers and a variety of sizes
- hang your compartment boxes on a wall space with the integrated hanging hook

Code	Description	UOM	Price
B33898	260 x 175 x 30mm, 48 Compartment	EACH	£3.75
B33832	260 x 185 x 50mm with Removeable Dividers	EACH	£4.95
B33897	300 x 220 x 35mm, 48 Compartment	EACH	£6.50
B33833	350 x 230 x 50mm with Removeable Dividers	EACH	£8.50
B33900	375 x 260 x 40mm, 48 Compartment	EACH	£8.75
B33899	375 x 260 x 40mm, 72 Compartment	EACH	£8.75
Price breaks available, see website			

Compartment Tray, Revolving

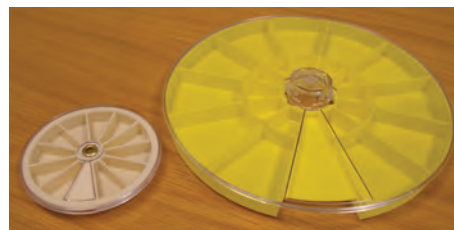

- Revolving plastic compartment tray
- Transparent lid with one opening so only one compartment is open at a time
- Ensures parts are accessible and visible but will not fall out or mix
- 11 or 22 compartments

- Overall diameter Ø90 or 190mm

Code	Description	UOM	Price
T47054	11 Compartments, Ø90mm	EACH	£1.25
T47055	22 Compartments, Ø190mm	EACH	£2.50

Plastic Boxes, Extendable



Plastic extendable boxes, excellent for storing delicate tools & items

- Strong plastic
- Extendable
- Great for files, gravers etc

Dimensions:

- Width (internal) x Height (Shortest length x Longest length)

Code	Description	UOM	Price
B47564	10 x 10mm (120 x 205mm) Box	PACK*5	£1.55
B47563	12 x 12mm (75 x 130mm) Box	PACK*5	£1.80
B47565	25 x 25mm (125 x 215mm) Box	PACK*5	£2.95
B47566	25 x 25mm (200 x 365mm) Box	PACK*3	£2.95

Plastic Pot (Square)



Sturdy square container to store or send delicate parts, including dials, movements and small castings

- Square
- Plastic
- Strong construction
- Hinged or removable lid

Code	Description	UOM	Price
B47051	41 x 32 x 12mm Box (Removable Lid)	PACK*10	£2.25
B41749	45 x 45 x 13mm Box (Hinged Lid)	PACK*10	£2.00
Price breaks available, see website			

Plastic Pots (Round)



Sturdy round container to store or send delicate parts, including dials, movements and small castings

- Round
- Screw rim
- Multiple sizes
- Plastic

- Hard plastic

Dimensions:

- Diameter x Overall height

Code	Description	UOM	Price
B47253	Ø30 x 15mm Pot	EACH	£0.25
B47254	Ø38 x 20mm Pot	EACH	£0.35
B47255	Ø50 x 20mm Pot	EACH	£0.60
B47256	Ø70 x 35mm Pot	EACH	£0.75

Price breaks available, see website

Plastic Pots in Box



- Multiple, removable compartments
- Inserts have thread action lids
- High quality
- Plastic
- See through for maximum visibility

Dimensions- overall size, (Insert size):

- B35515: 160 x 120 x 25mm, (Ø38 x 20mm)
- B47053: 160 x 135 x 25mm (Ø30 x 19mm) (non thread action lids)

Code	Description	UOM	Price
B35515	12 Round Compartments, 160 x 120 x 25mm	EACH	£7.50
B47053	20 Round Compartments, 160 x 135 x 25mm	EACH	£2.95

Plastic Pots in Box



- Multiple, removable compartments
- Plastic
- Compartments have clear lids

Dimensions - overall size, (Insert size):

- B32995: 165 x 140 x 25mm, (60 x 50 x 15mm)
- B32394: 165 x 140 x 25mm, (Ø30 x 17mm)

Code	Description	UOM	Price
B32995	6 Rectangular Boxes, 165 x 140 x 25mm	EACH	£2.45
B32394	20 Round Compartments, 165 x 140 x 25mm	EACH	£2.95



Plastic Pots in Box, Swiss Made



- Plastic pots in box
- For spare parts
- 260 x 105 x 24mm
- Bergeon Swiss or Swiss made

Comprising:

- 21 x Ø21mm Round Boxes
- 2 x Ø40mm Round Boxes

Code	Description	UOM	Price
B0134	23 Round Compartment Storage Box, Bergeon 6088D	EACH	£23.50
B41943	23 Round Compartment Storage Box, Swiss Made	EACH	£18.95

Price breaks available, see website

Membrane Boxes

These patented boxes are transparent and allow the arrangement, packing and shipment of fragile items, of every shape, for the jewellery, horological & electronic industries etc.

- Elastic membrane boxes
- Individual size: 39 x 39 x 17.8mm
- Supplied individually, pack*6, pack*12 or a pack*100
- The items are suspended between the membranes of the box and the cover

Membrane Box, Individual, Non Swiss



- Elastic Membrane Box
- Made in China
- 39 x39 x17.8mm

Code	Description	UOM	Price
B5592	Membrane Box, Individual, Non Swiss	PACK*100	£29.95

Membrane Box, Individual, Bergeon 6799.01



- High Quality
- Elastic Membrane Box
- Bergeon 6799.01
- 39 x39 x17.8mm

Code	Description	UOM	Price
B32287	Membrane Box, Individual, Bergeon 6799.01	EACH	£2.90

Membrane Box, Set of 6, Bergeon 6799.06



- High Quality
- Elastic Membrane Box
- Bergeon 6799.06
- 120 x 79 x 17.8mm

Code	Description	UOM	Price
B32288	Membrane Box, Set of 6, Bergeon 6799.06	PACK*6	£15.25

Membrane Box, Set of 12, Bergeon 6799.12



- High Quality
- Elastic Membrane Box
- Bergeon 6799.12
- 240 x 79 x 17.8mm

Code	Description	UOM	Price
B32289	Membrane Box, Set of 12, Bergeon 6799.12	PACK*12	£25.50

Price breaks available, see website



Tubes & Watch Part Containers

- Excellent for storing fine parts, crowns, watch hands, stems, gemstones etc
- Use the tubes in conjunction with B8744 to truly keep your parts organised and accessible

Box for Watch Parts



- External Diameter Ø17mm
- 50 pieces

Code	Description	UOM	Price
B31092	Box for Watch Parts	PACK*50	£4.25

Tubes for Watch Parts, Cylinder



External: 8 x 27mm (Including Lid)
Internal: 6mm
(Red Lid)
100 pieces

Code	Description	UOM	Price
T31091	Tubes for Watch Parts, Cylinder	PACK*100	£4.95

Tubes for Watch Parts, Rectangle



- External: 7.5 x 7.5 x 23mm
- Internal: 5 x 5 x 19mm
- Lid colour may vary
- 100 pieces each lids & tubes

Code	Description	UOM	Price
T47707	Tubes for Watch Parts, Rectangle	PACK*100	£7.95

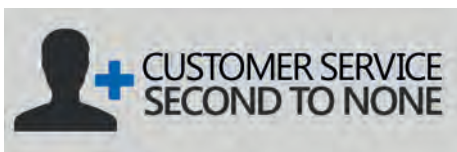

Tubes for Watch Parts, Rectangle, Horotec Swiss



- External: 9 x 9 x 23mm
- Internal: 6 x 6 x 19mm
- Lid colour may vary
- 100 pieces each lids & tubes

Code	Description	UOM	Price
T1723	Tubes for Watch Parts, Rectangle, Horotec Swiss	PACK*100	£14.95

DISPENSERS

Dispenser



Dispenser

- Great for storing and dispensing finger cots, tags & labels or any small items
- Provides easy access & storage for regularly used items
- 3 or 4 compartments
- Transparent acrylic with neutral outer casing
- Tilting transparent compartments offer easy access and refilling
- Can be fixed to the wall or sit on a desk

Dimensions:

- B53350: 600 x 160 x 240mm (length x depth x height)
- B53351: 600 x 140 x 210mm (length x depth x height)

Code	Description	UOM	Price
B53350	3 Compartment Dispenser	EACH	£44.95
B53351	4 Compartment Dispenser	EACH	£48.95
Price breaks available, see website			

Dispenser, Bergeon Swiss

Dispenser - Bergeon Swiss

- Great for storing and dispensing finger cots, tags & labels or any small items
- Provides easy access & storage for regularly used items
- Solid, transparent acrylic
- Hinged access lid
- Can be filled from the top
- Two or more can be screwed together
- Bergeon 7872
- 250 x 120 x 370mm (L x W x H)



Code	Description	UOM	Price
T28776	Acrylic Glass Thimbles Machine	EACH	£79.95



DISPLAY & TRANSPORT BOXES & PRESENTATION TRAYS

Gemstone Display & Protection Boxes



Used by gemstone dealers, jewellers, watch and clock part makers/repairs, electronic components industry and collectors.

- Light weight plastic
- Glass top for crystal clear viewing
- Soft foam padding inside
- Padding is reversible, can be either black or white
- The special padding is accurately cut to ensure rattle reduction of gem stones and components
- The glass lens is very useful for viewing items without opening the protection box for display, excellent for display and protection purposes
- A range of compact sizes available for easy transportation (please see below)

Sizes available (External) height x width x depth:

- 25 x 25 x 20mm
- 40 x 40 x 20mm
- 50 x 50 x 20mm
- 100 x 75 x 25mm

Code	Description	UOM	Price
B31448	25 x 25mm White Box	EACH	£0.80
B31452	25 x 25mm Black Box	EACH	£0.80
B31449	40 x 40mm White Box	EACH	£0.95
B31453	40 x 40mm Black Box	EACH	£0.95
B31450	50 x 50mm White Box	EACH	£1.35
B31454	50 x 50mm Black Box	EACH	£1.35
B31451	100 x 75mm White Box	EACH	£2.65
B31455	100 x 75mm Black Box	EACH	£2.65
Price breaks available, see website			

Gemstone Display & Protection Boxes in Cases

Used by gemstone dealers & jewellers, watch and clock part makers/repairs, electronic components industry and collectors.

- Clear viewing
- Soft white foam padding inside
- The special padding is accurately cut to ensure rattle reduction of gem stones and components
- The glass lens is very useful for viewing items without opening the protection box for display, excellent for display and protection purposes



Case with 24 Boxes (Ø30mm)



- Contains 24 removable thread action, round, plastic chrome style finish gem boxes with glass window
- Diameter of window Ø20mm
- Lockable catch lid
- Stylish chrome and black dotted finish
- Suede finish compartment holders and top lid giving you the professional look

Overall size: 230 x 165 x 30mm
 Individual gemstone box size: Ø30 x 15mm
 Weight: 550g

Code	Description	UOM	Price
C36091	Case with 24 Boxes (Ø30mm)	EACH	£22.95

Case with 25 Boxes (25 x 25mm)



- Gemstone Leather Box with Clear Glass Top.
- Holds 25 square smaller white gem boxes of size 1" x 1" (Included)
- 185 x 185mm overall size
- Weight 500g

Code	Description	UOM	Price
G31314	Case with 25 Boxes (25 x 25mm)	EACH	£16.50

Case with 25 Boxes (25 x 25mm)



- Gemstone Leather Box with Clear Glass Top
- Holds 25 square smaller black gem boxes of size 1" x 1" (Included)
- 185 x 185mm overall size

• Weight 500g

Code	Description	UOM	Price
G43013	Case with 25 Boxes (25 x 25mm)	EACH	£17.65

Tray with 16 Boxes (45 x 60mm)

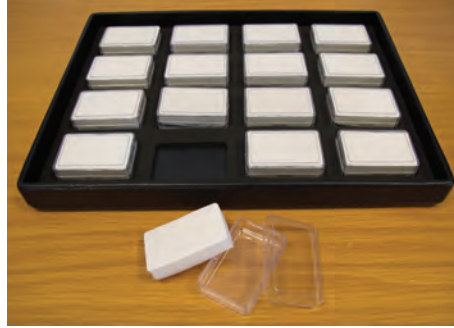

- 16 clear plastic removable boxes (45 x 60mm)
- Faux leather case with felt insert
- Without lid for ease of access & better visual display
- 300 x 230mm overall size

Code	Description	UOM	Price
G47698	Tray with 16 Boxes (45 x 60mm)	EACH	£17.95

Tray with 24 Boxes (35 x 35mm)



- Contains 24 removable boxes
- Removable boxes size 35 x 35mm
- Faux leather case with felt insert
- Without lid for ease of access & better visual display
- 300 x 230mm overall size

Code	Description	UOM	Price
B46148	Tray with 24 Boxes (35 x 35mm)	EACH	£15.95

Tray with 24 Boxes (45 x 45mm)



- 24 clear plastic removable boxes (35 x 35mm)
- Faux leather case with felt insert
- Without lid for ease of access & better visual display
- 300 x 230mm overall size

Code	Description	UOM	Price
G47699	Tray with 24 Boxes (45 x 45mm)	EACH	£17.95

Tray with 35 Boxes (25 x 25mm)



- Contains 35 removable boxes
- Removable boxes size 25 x 25mm

- Faux leather case with felt insert
- Without lid for ease of access & better visual display
- 300 x 230mm overall size

Code	Description	UOM	Price
B46147	Tray with 35 Boxes (25 x 25mm)	EACH	£15.95

Gemstone Display & Transportation Boxes

Box 5 Groove (Diamond Testing & Transportation)

Used to examine diamonds. The white background enables you to spot with a loupe flaws easier.



Ideal for short term transportation and storage.

- Dimensions: Width 64mm x Depth 40mm x Height 25mm

Code	Description	UOM	Price
T31263	Box 5 Groove (Diamond Testing & Transportation)	EACH	£2.95

Box 10 Groove (Diamond Testing & Transportation)

Used to examine diamonds. The white background enables you to spot with a loupe flaws easier.



Ideal for short term transportation and storage.

- Dimensions: Width 64mm x Depth 40mm x Height 25mm

Code	Description	UOM	Price
T31264	Box 10 Groove (Diamond Testing & Transportation)	EACH	£3.20

Display Stand for Gemstones

Ideal for retailers to show their loose stones.

- 4 prong
- Heavy Metal Base
- Weight 10gm
- Height 85mm
- Base Ø22mm



Code	Description	UOM	Price
G31315	Display Stand for Gemstones	EACH	£2.35



Display Holder for Gemstones, Gold Colour, 0.5 to 2.5 Carat

The essential and most effortless crutch for selling diamonds!!

- Gold colour
- Holds 0.5 to 2.5 carat size stones
- Spring loaded shank to flexibly open and close the claws

After the customer has chosen a gemstone, place the gemstone into the holder and place on the customer's finger, giving the customer the optimum idea of how their ring will look. Essential in any jewellers, this Gem Stone Holder gives you and your sales assistants an impressive and incomparable selling edge.

Why not display all gemstones using this tool to encourage impulsive purchases

Code	Description	UOM	Price
S12165	Display Holder for Gemstones, Gold Colour, 0.5 to 2.5 Carat	EACH	£1.35



Display Holder for Gemstones, Gold Colour, 2 to 5 Carat

The essential and most effortless crutch for selling diamonds!!

- Gold colour
- Holds 2 to 5 carat size stones
- Spring loaded shank to flexibly open and close the claws

After the customer has chosen a gemstone, place the gemstone into the holder and place on the customer's finger, giving the customer the optimum idea of how their ring will look. Essential in any jewellers, this Gem Stone Holder gives you and your sales assistants an impressive and incomparable selling edge.

Why not display all gemstones using this tool to encourage impulsive purchases

Code	Description	UOM	Price
S49837	Display Holder for Gemstones, Gold Colour, 2 to 5 Carat	EACH	£1.40



Display Holder for Gemstones, Silver Colour, 0.5 to 2.5 Carat

The essential and most effortless crutch for selling diamonds!!

- Silver colour
- Holds 0.5 to 2.5 carat size stones
- Spring loaded shank to flexibly open and close the claws

After the customer has chosen a gemstone, place the gemstone into the holder and place on the customer's finger, giving the customer the optimum idea of how their ring will look. Essential in any jewellers, this Gem Stone Holder gives you and your sales assistants an impressive and incomparable selling edge.

Why not display all gemstones using this tool to encourage impulsive purchases?

Code	Description	UOM	Price
S12164	Display Holder for Gemstones, Silver Colour, 0.5 to 2.5 Carat	EACH	£1.35



Display Holder for Gemstones, Silver Colour, 2 to 5 Carat

The essential and most effortless crutch for selling diamonds!!

- Silver colour
- Holds 2 to 5 carat size stones
- Spring loaded shank to flexibly open and close the claws

After the customer has chosen a gemstone, place the gemstone into the holder and place on the customer's finger, giving the customer the optimum idea of how their ring will look. Essential in any jewellers, this Gem Stone Holder gives you and your sales assistants an impressive and incomparable selling edge.

Why not display all gemstones using this tool to encourage impulsive purchases?

Code	Description	UOM	Price
S49838	Display Holder for Gemstones, Silver Colour, 2 to 5 Carat	EACH	£1.40



Holder for 20 Gemstones, Plastic

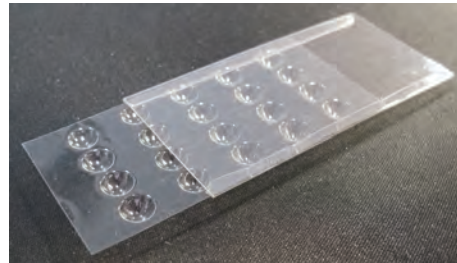

Very useful to put inside parcel papers to avoid stones from falling out.

Code	Description	UOM	Price
S31304	Holder for 20 Gemstones, Plastic	EACH	£0.75

Holder for 55 Gemstones, Plastic

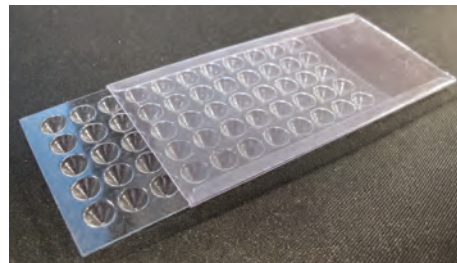

Code	Description	UOM	Price
S31305	Holder for 55 Gemstones, Plastic	EACH	£0.75

Holder for 72 Gemstones, Plastic

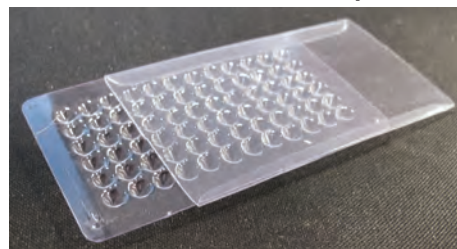

Very useful to put inside parcel papers to avoid stones from falling out.

For small diamonds 0.15ct

Code	Description	UOM	Price
S31306	Holder for 72 Gemstones, Plastic	EACH	£0.95

Gemstone Storage & Transportation Pouch



- Traditional gemstone pouch
- Leatherette
- Close with a drawstring
- 105 x 75mm (height x width)
- Black or brown

Code	Description	UOM	Price
P42902	Black Pouch for Precious Stones	EACH	£0.95
P44207	Brown Pouch for Precious Stones	EACH	£0.95

Presentation or Displaying Tray



- Bergeon 2962
- Swiss
- Perfect Finish
- Velvet Covered
- Size: 320 x 220 x 14mm

Velvet covered, perfect finish presentation tray for the most prestigious of retail environments.

Code	Description	UOM	Price
T32992	Displaying Tray / Showing Plate	EACH	£23.95

Ring Display Pads



Ring Display Case

- Excellent for window or counter displays
- Black leather base
- Grey suede internal finish
- Can hold 36 rings
- 200 x 25mm

Code	Description	UOM	Price
R49719	Ring Display Pad	EACH	£14.95

Price breaks available, see website



Watch Display Cases



Watch Display Cases

- Excellent for window or counter displays
- 2 different colours
- Transparent lid
- Plastic base and lid
- Great value
- Base 45 x 80mm
- Height 85mm

Code	Description	UOM	Price
B47570	Maroon Watch Display	EACH	£0.95
B47567	Red Watch Display	EACH	£0.95

Price breaks available, see website

Watch Display & Storage Case



Watch Display & Storage Cases

- Single watch display or storage case
- Flat, stackable cases
- Rectangular so fit easily in draws or cabinets
- Excellent for window or counter displays
- Transparent lid
- Red insert
- Plastic base and lid
- Great value
- 115 x 45mm

Code	Description	UOM	Price
B49275	Red Insert Watch Display & Storage Case	EACH	£0.75

Price breaks available, see website

Watch Transport & Storage Pouch



Watch Transport & Storage Pouch

- Leather pouches for watch transportation or storage
- Black or brown leather
- With popper or Velcro
- White stitching
- Perfect for selling watches or storing them safely

Dimensions
 • 145 x 70 x 30mm (height x width x depth)

Code	Description	UOM	Price
P53420	Black Pouch with Popper	EACH	£3.95
P53421	Black Pouch with Velcro	EACH	£3.95
P53422	Brown Pouch with Popper	EACH	£3.95
P53423	Brown Pouch with Velcro	EACH	£3.95

Price breaks available, see website

DISPLAY DOMES & STANDS

Display Dome



Display Dome & Base

Ideal for displaying watches & collectables etc. under an acrylic dome and synthetic or wooden base.

- Clear acrylic
- Dark textured synthetic or wooden base available
- Weighted base for extra stability
- Rigid internal metal hook (colour may vary between gilt and chrome)
- Popular Model

Dimensions: Ø75mm x Height 100mm

Code	Description	UOM	Price
D0428	Ø75mm x 100mm Dome & Base (Black Synthetic Base)	EACH	£6.25
D50160	Ø75mm x 100mm Dome & Base (Black Wooden Base)	EACH	£8.95

Price breaks available, see website

Pocket Watch Display Holders



- Brass
- Opening to Ø55mm
- Weight 200g

Code	Description	UOM	Price
C31301	1 Arm Brass Case Holder	EACH	£13.65
C31302	2 Arm Brass Case Holder	EACH	£13.65

Pocket Watch Stands

Pocket Watch Stands

Let your pocket-watch take pride of place on display in your shop window, on your desk, or even on your mantle piece. As budget items the plating may not be perfect.

- Gold plated & chrome
- Antique finish with imperfections
- Multiple designs
- Free standing

Half Arch, Chrome

- Half arch
- Chrome
- 120mm height
- Ø55mm base
- 50mm arm



Code	Description	UOM	Price
P39716	Half Arch, Chrome	EACH	£9.95

Half Arch, GP

- Half arch
- Gold plated
- 120mm height
- Ø55mm base
- 50mm arm



Code	Description	UOM	Price
P39717	Half Arch, GP	EACH	£10.95

Full Arch, Chrome

- Chrome
- 140 x 100 x 25mm (Height x width x depth)



Code	Description	UOM	Price
P39718	Full Arch, Chrome	EACH	£13.50

ONLINE F.A.Q.



Full Arch, GP

- Full arch
- Gold plated
- 140 x 100 x 25mm (Height x width x depth)



Code	Description	UOM	Price
P39719	Full Arch, GP	EACH	£13.50

Straight Arm, Chrome

- Straight arm
- Chrome
- 95mm height
- Ø55mm base
- 30mm arm



Code	Description	UOM	Price
P39720	Straight Arm, Chrome	EACH	£8.50

Straight Arm, GP

- Straight arm
- Gold plated
- 95mm height
- Ø55mm base
- 30mm arm



Code	Description	UOM	Price
P39721	Straight Arm, GP	EACH	£8.50

DISPLAY TURNTABLES

Mirror Display Turntables

Maximize window displays with these eye catching turntables. Display jewellery, watches, gifts or anything you desire to create a focal point of a display, enhancing the sales of slower sellers and also to entice customers into the selling environment.

- Fully mirrored, eye catching and light enhancing
- Various sizes are available from large to small (please see the listings below)
- The top table cover disc where products are displayed is one glass mirror piece
- The base unit is made of light weight plastic and the entire surrounding table is finished

with small mirrors

- As the unit rotates the mirror attracts light prominently enhancing the attractiveness of the display
- Products rotate a full 360° on this turntable giving customers a comprehensive view of the displayed line
- The unit is battery operated giving approximately a 300 to 500 hour life span (batteries not included)
- The largest turntable comes complete with mains adaptor whilst still having the portable battery option

Specifications:

- Max load 2Kg
- 1.3 RPM (rotations per minute)
- For batteries required please see specific "more info" for each item

Dimensions:

- Table diameter Ø x overall height

Ø90 x 65mm Display Turntable

- Comprised with a parallel wall
- Battery: 1 x AA/LR6 (code MN1500)
- Speed: 1.3rpm
- Max load: 2kg
- Dimensions: 90 x 65mm
- Weight: 250gr



Code	Description	UOM	Price
T32985	Ø90 x 65mm Display Turntable	EACH	£19.95

Ø128 x 65mm Display Turntable

- Comprised with a parallel wall
- Battery needed: 1 x C (code MN1400)
- Speed: 1.3rpm
- Max load: 2Kg
- Dimensions: 128 x 65mm
- Weight: 375grm



Code	Description	UOM	Price
T32986	Ø128 x 65mm Display Turntable	EACH	£22.50

Ø128 x 65mm Display Turntable, Stepped

- Surrounded with a stepped mirror rim
- Battery: 1 x C (code MN1400)
- Speed: 1.3RPM
- Max load: 2Kg
- Dimensions: 128 x 65mm
- Weight: 365gr



Code	Description	UOM	Price
T32987	Ø128 x 65mm Display Turntable, Stepped	EACH	£24.95

Solar Power Display Turntables



Solar powered display turntables allow you to display your items without the worry of having to change batteries or turn them off at night! Efficient and reliable, they will help display and sell your stock to new and existing customers

- Solar powered, no batteries required!
- Ø90mm diameter plastic turntable
- Base 110 x 110 x 50mm
- Available in black, gold or silver
- Can also be powered by AA battery if required (not included)

Specifications:

- Max load 300g
- 4.5 RPM (rotations per minute)
- 4 solar panels

Code	Description	UOM	Price
T49292	Black Display Turntable	EACH	£3.75
T49290	Gold Display Turntable	EACH	£3.95
T49291	Silver Display Turntable	EACH	£3.95

Price breaks available, see website

Solar Power Display Turntables with LED



This solar powered display turntable combines efficiency and display prowess. Can either be used solely as a solar powered display turntable, or insert x1 AA battery to operate 4 LED lights, illuminating your display piece for the world to see!

- Solar powered, no batteries required!
- 4 LED's (operate with battery inserted)
- Ø90mm diameter plastic turntable
- Base 110 x 110 x 90mm
- Black on 4 raised legs

Specifications:

- Max load 300g
- 4.5 RPM (rotations per minute)
- 4 solar panels
- 4 LED's

Code	Description	UOM	Price
T49293	LED Display Turntable	EACH	£4.50

Price breaks available, see website

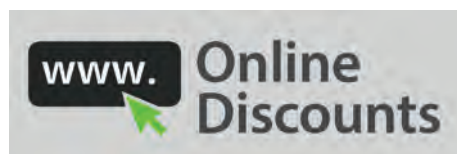

DUST COVERS & TRAYS

There is nothing more frustrating in your busy workshop than not being organised enough to store and access your parts, components or apparatus. Many a watchmaker, repairer or jeweller have lost or misplaced vital parts, proving costly in both time and monetary value to replace if forever lost.

Take a look at our comprehensive range of small parts storage solutions which have the capability to save you a lot of time and money in your workshop. Available we have storage compartment containers with lids, in sections, different colours and even stackable trays.

Dust Cover on Divider Tray

- Ø100mm base
- Plastic cover with knob
- Plastic partitioned tray
- Spare tray or cover available separately
- Bergeon Swiss or unbranded

Dust Cover & Tray, Bergeon



- Bergeon 30097BC
- Ø100mm
- Plastic cover with knob
- Plastic partitioned tray

Code	Description	UOM	Price
D4772	Dust Cover & Tray, Bergeon	EACH	£13.75

Dust Cover, Bergeon



- Bergeon 30097C
- Fits Ø100mm base

- Plastic cover with knob

Code	Description	UOM	Price
D0457	Dust Cover, Bergeon	EACH	£10.95

Tray with Divisions, Bergeon Swiss



- Bergeon 30097B
- Ø100mm
- Plastic partitioned tray

Code	Description	UOM	Price
T1719	Tray with Divisions, Bergeon Swiss	EACH	£5.85

Tray Extension Cylinder, Bergeon



Extension Cylinder Only (Base & Lid not included)

- Bergeon 300097-RH - Swiss Made
- Stack multiple dust cover trays with this extension, giving even more storage on a busy work bench
- Make your dust cover capable of holding larger items

Code	Description	UOM	Price
D45569	Tray Extension Cylinder, Bergeon	EACH	£10.50

Dust Cover & Tray, Cousins



- Ø100mm

- Plastic cover with knob
- Plastic partitioned tray

Code	Description	UOM	Price
D6114	Dust Cover & Tray, Cousins	EACH	£2.25

Dust Cover & Two Trays



- Ø100mm
- Plastic cover with knob
- 1 x partitioned tray
- 1 x tray with no partitions

Code	Description	UOM	Price
D47500	Dust Cover & Two Trays	EACH	£3.15

Dust Cover on Divider Tray, Extra Large

Dust Cover with Tray, Extra Large



- Ø155mm base
- 150mm overall height
- Plastic cover with knob
- Plastic partitioned tray
- Bergeon 30097-XL-BC

Code	Description	UOM	Price
D45747	Dust Cover with Tray, Extra Large	EACH	£31.50

Dust Cover, Rectangular



- Bergeon 6759.2 - Swiss Made
- Rectangular dust cover
- Plexiglass

- Strong and well finished
- With handle for easy lifting
- Very transparent

Dimensions:
• Size 90 x 225 x 43mm

Code	Description	UOM	Price
D51485	Dust Cover, Bergeon	EACH	£66.85

Dust Cover, Square



- Bergeon 6759.6 - Swiss Made
- Square dust cover
 - Plexiglass
 - Strong and well finished
 - With handle for easy lifting
 - Very transparent

Dimensions:
• Size 200 x 275 x 60mm

Code	Description	UOM	Price
D51586	Dust Cover, Bergeon 6759.6	EACH	£74.95

Dust Cover, for Use with Witschi Microphone



Horotec - Dust Cover

- Dust cover for movements whilst they are mounted on a Witschi microphone
- Especially designed for use with the Witschi mechanical microphone
- Horotec 19.198

Code	Description	UOM	Price
T52813	Dust Cover for Witschi Microphone	EACH	£24.95

Tray, Bench



Multi-purpose rectangular utility tray to store & move tools & components easily which are very handy in a busy workshop or retail environment

- Rectangular
- Deep blue colour
- Great for tools, components & more
- Multiple different size compartments
- 6 compartments in total
- Take your tools with you when you change benches
- Treated MDF, lightweight and durable

Dimensions:
• 310 x 215 x 25mm (length x width x height)

Code	Description	UOM	Price
B52506	Bench Tray	EACH	£12.95

Tray, Bench

Multi-purpose rectangular utility tray to store & move tools & components easily which are very handy in a busy workshop or retail environment

- Rectangular
- Natural colour
- Great for tools, components & more
- Divides can be removed and repositioned to create larger or smaller spaces
- Up to 15 compartments possible
- Take your tools with you when you change benches
- Treated MDF, lightweight and durable

Dimensions:
• 210 x 160 x 35mm

15 Compartment Tray



Dimensions:
• 210 x 160 x 35mm

Code	Description	UOM	Price
B53975	15 Compartment Tray	EACH	£12.95

Trays, Small Rectangular

Multi-purpose rectangular utility trays which are very handy in a busy workshop or retail environment

- Plastic
- Rectangular
- Black or white
- Great for watch parts or small components
- Dimensions: Length x width x depth

100 x 60 x 15mm, Black



- 100 x 60 x 15mm
- Black

Code	Description	UOM	Price
T39049	100 x 60 x 15mm, Black	EACH	£0.95

100 x 60 x 15mm, White



- 100 x 60 x 15mm
- White

Code	Description	UOM	Price
T39048	100 x 60 x 15mm, White	EACH	£0.95

150 x 105 x 25mm, White



- 150 x 105 x 25mm
- White

Code	Description	UOM	Price
T39051	150 x 105 x 25mm, White	EACH	£1.50



VALUE



Refs: T4914 & T45551

Reverse Action Tweezers

See Page 1049

VALUE



Refs: T4913 & T45550

Trays, Small Square



- Stackable
- Choice of colours
- Choice of sizes
- Bergeon Swiss

Square Size x Depth:

- 30mm x 9mm - Bergeon 2362
- 50mm x 10mm - Bergeon 2378
- 70mm x 13mm - Bergeon 2379

Code	Description	UOM	Price
T1715	Beige (50mm x 10mm) Tray	EACH	£9.95
T1716	Beige (70mm x 13mm) Tray	EACH	£10.50
T1715A	Black (50mm x 10mm) Tray	EACH	£9.95
T1716A	Black (70mm x 13mm) Tray	EACH	£10.50
T1714B	Blue (30mm x 9mm) Tray	EACH	£17.95
T1715B	Blue (50mm x 10mm) Tray	EACH	£9.95
T1716B	Blue (70mm x 13mm) Tray	EACH	£10.50
T1714C	Green (30mm x 9mm) Tray	EACH	£17.95
T1715C	Green (50mm x 10mm) Tray	EACH	£9.95
T1716C	Green (70mm x 13mm) Tray	EACH	£10.50
T1715D	Orange (50mm x 10mm) Tray	EACH	£9.95
T1716D	Orange (70mm x 13mm) Tray	EACH	£10.50
T1714E	Red (30mm x 9mm) Tray	EACH	£17.95
T1715E	Red (50mm x 10mm) Tray	EACH	£9.95
T1716E	Red (70mm x 13mm) Tray	EACH	£10.50
T1714F	White (30mm x 9mm) Tray	EACH	£17.95
T1715F	White (50mm x 10mm) Tray	EACH	£9.95
T1716F	White (70mm x 13mm) Tray	EACH	£10.50
T1714G	Yellow (30mm x 9mm) Tray	EACH	£17.95
T1715G	Yellow (50mm x 10mm) Tray	EACH	£9.95
T1716G	Yellow (70mm x 13mm) Tray	EACH	£10.50

Trays, Small Triangular

Triangular Tray, Aluminium



- 90 x 90 x 90mm
- Aluminium
- Great for watch parts or small components

Code	Description	UOM	Price
T39050	Triangular Tray, Aluminium	EACH	£0.95

Triangular Tray, Plastic



- 90 x 90 x 90mm
- Plastic
- White
- Great for watch parts or small components

Code	Description	UOM	Price
T1718	Triangular Tray, Plastic	EACH	£0.95

Trays, Small Weighing



Lightweight weighing trays suitable for diamond or precious metal scales.

- Lightweight
- Aluminium
- Black & white
- Handles & spout make it easy to pour, tip or place gold and gemstones
- Pack*2

Dimensions:
• 130 x 80 x 30mm
• Weight: 12g

Code	Description	UOM	Price
G39602	Diamond & Gold Weighing Cups	PACK*2	£4.95

Trays, Watch Disassembly & Assembly, Swiss

Stackable Plastic Compartment Trays for Watch Disassembly & Assembly

- 1 set of stackable 5 trays
- Each tray is a different colour
- Supplied with transparent lid
- Each tray has 6 compartments
- Overall Size Ø89 x 94mm (diameter x height)
- Each tray internal height is 15mm
- Each division height within each tray is 4mm
- Plastic
- Horotec 17.850

Code	Description	UOM	Price
T52792	Set of 5 Trays, Horotec 17.850	EACH	£17.95



Trays, Watch Disassembly & Assembly

Stackable Plastic Compartment Trays for Watch Disassembly & Assembly

- 1 set of 5 stackable trays
- Round shape
- Each tray is a different colour
- Supplied with transparent lid
- Each tray has 6 compartments
- Overall Size Ø89 x 94mm (diameter x height)
- Each tray internal height is 15mm
- Each division height within each tray is 4mm
- Plastic
- Made in Taiwan



Code	Description	UOM	Price
T55404	Set of 5 trays & Lid	PACK*5	£11.25

Trays, Watch Disassembly & Assembly

Stackable Plastic Compartment Trays for Watch Disassembly & Assembly

- 1 set of 5 stackable trays
- Square shape
- Each tray is a different colour
- Supplied with transparent lid
- Each tray has 4 compartments
- Overall Size 74 x 74mm
- Each tray internal height is 15mm
- Each division height within each tray is 4mm
- Plastic
- Made in Taiwan



Code	Description	UOM	Price
T55405	Set of 5 Square Trays & Lid	PACK*5	£11.25

Trays, Watch Disassembly & Assembly



Stackable Plastic Compartment Trays for Watch Disassembly & Assembly

- 1 set of 5 stackable trays
- Rectangular shape
- Each tray is a different colour
- Supplied with transparent lid
- Each tray has 6 compartments
- Overall Size 120 x 53mm
- Each tray internal height is 15mm
- Each division height within each tray is 4mm
- Plastic
- Made in Taiwan

Code	Description	UOM	Price
T55406	Set of 5 Rectangle Trays & Lid	PACK*5	£11.25

Trays, Watch Disassembly & Assembly, Swiss

Stackable Plastic Compartment Trays with Stackable Lids for Watch Disassembly & Assembly

- Various colours
- 2 Different Compartment Formats
- Overall Size 245 x 115 x 20mm
- Small Compartment Cavities: 49 x 45 x 16mm
- Large Compartment Cavities: 234 x 42 x 16mm
- Lids Sold Separately
- Weight 110g (Trays)
- Weight 90g (Lid)
- Made in Switzerland

Blue 6 Compartment Tray



Code	Description	UOM	Price
B34425	Blue 6 Compartment Tray	EACH	£3.15

Blue 10 Compartment Tray



Code	Description	UOM	Price
B34429	Blue 10 Compartment Tray	EACH	£3.25

Green 6 Compartment Tray



Code	Description	UOM	Price
B34428	Green 6 Compartment Tray	EACH	£3.15

Green 10 Compartment Tray



Code	Description	UOM	Price
B34432	Green 10 Compartment Tray	EACH	£3.25

Red 6 Compartment Tray



Code	Description	UOM	Price
B34427	Red 6 Compartment Tray	EACH	£3.15

Red 10 Compartment Tray



Code	Description	UOM	Price
B34431	Red 10 Compartment Tray	EACH	£3.25

Yellow 6 Compartment Tray



Code	Description	UOM	Price
B34426	Yellow 6 Compartment Tray	EACH	£3.15

Yellow 10 Compartment Tray



Code	Description	UOM	Price
B34430	Yellow 10 Compartment Tray	EACH	£3.25

Transparent Compartment Lid



Code	Description	UOM	Price
B34433	Transparent Compartment Lid	EACH	£2.25

Plastic Key (Black) for 1 Lid & 1 Tray

- To lock one lid to one tray



Code	Description	UOM	Price
T34439	Plastic Key (Black) for 1 Lid & 1 Tray	EACH	£1.25

Plastic Key (Yellow) 1 Lid & 2 Trays

- To lock one lid to two trays



Code	Description	UOM	Price
T34440	Plastic Key (Yellow) 1 Lid & 2 Trays	EACH	£1.25

Plastic Key (Red) 1 Lid & 3 Trays

- To lock one lid to three trays



Code	Description	UOM	Price
T34441	Plastic Key (Red) 1 Lid & 3 Trays	EACH	£1.25

Plastic Key (Green) 1 Lid & 4 Trays

- To lock one lid to four trays



Code	Description	UOM	Price
T34442	Plastic Key (Green) 1 Lid & 4 Trays	EACH	£1.25

Plastic Key (Blue) 1 Lid & 5 Trays

- To lock one lid to five trays



Code	Description	UOM	Price
T34443	Plastic Key (Blue) 1 Lid & 5 Trays	EACH	£1.25



Foam Insert for Small Compartment Cavities



- For Small Compartment Cavities: 49 x 45 x 16mm

Code	Description	UOM	Price
T34444	Foam Insert for Small Compartment Cavities	PACK*5	£0.80

Foam Insert for Small Compartment Cavities



- For Small Compartment Cavities: 49 x 45 x 16mm

Code	Description	UOM	Price
T52958	Foam Insert for Small Compartment Cavities	PACK*100	£11.95

Foam Insert for Large Compartment Cavities



- For Large Compartment Cavities: 234 x 42 x 16mm

Code	Description	UOM	Price
T34445	Foam Insert for Large Compartment Cavities Price breaks available, see website	EACH	£0.55

FUNNELS, JUGS & LIQUID DISPENSERS

Beaker

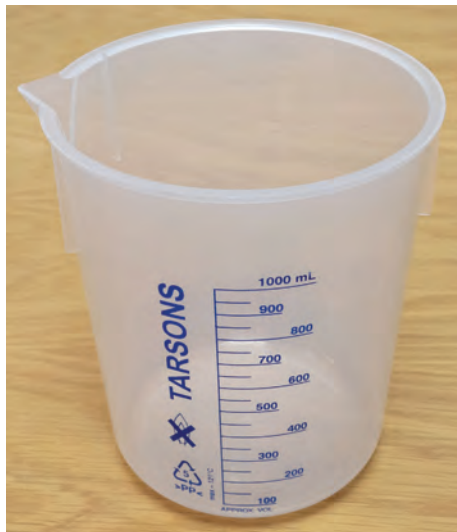

Beaker

Ideal for many filling and emptying application within the workshop

- Quality product with easy to read measurements
- Well designed spout for easy pouring
- Suitable for measuring all liquids
- up to 1000ml

Code	Description	UOM	Price
B56298	Beaker 1 Litre	EACH	£5.95

Funnels



Ideal for avoiding spillages when filling and emptying fluids or grains within the workshop

- Ideal for transferring liquid or fine-grained substances
- 3 different diameters available

Code	Description	UOM	Price
F32077	Ø8cm Funnel	EACH	£1.45
F32076	Ø14cm Funnel	EACH	£1.65
F32075	Ø18cm Funnel	EACH	£1.95

Jugs



Measuring Jug - Imperial

Ideal for many filling and emptying application within the workshop

- Quality product with easy to read measurements
- Well designed spout for easy pouring
- Suitable for measuring all liquids

Code	Description	UOM	Price
J32080	0.57 Litres (1 Pint) Measuring Jug	EACH	£1.45
J32079	1.14 Litres (2 Pints) Measuring Jug	EACH	£1.85

Liquid Dispenser



Liquid Dispenser (popular for soldering flux)

Loss of solutions due to knocking over, evaporation, contamination, etc is an ever present and costly problem when jobbing, this liquid dispenser is ideal for eradicating these issues.

Fill the bottle with the chemical of your choice. The lid flips open to expose a reservoir, press down to dispense a small quantity of the solution. To fill the reservoir completely press it between four and six

times, (although this is not necessary), this process restricts solution exposed as well as wastage. Apply the solution using an applicable brush such as a fine flux brush when applying Auflux to solder joints.

- The liquid dispenser holds up to 150ml of solution.
- The reservoir holds up to 15ml of solution.
- Allows the user to work with unpleasant odours confidently making it unnecessary to distribute large amounts of solution in other containers.

Some Chemicals Cousins supplies used in the Liquid Dispenser

- Auflux Soldering Flux Liquid (C4354)
- Hair Spring Degreaser Cleaning Fluid (F2811)
- Aging Chemicals (C20952)
- Lacomit and Lacomit Remover (C4366 & C4369)

Size and Weight:
110mm x 50mm x 50mm - 80g

Code	Description	UOM	Price
D32989	Liquid Dispenser	EACH	£6.75

Liquid Dispenser, Fine Tipped

Excellent for dispensing solder flux for wetting small to large joints with accuracy

Capacity: 100ml



Code	Description	UOM	Price
D34941	Liquid Dispenser, Fine tipped	EACH	£1.25

LEMEL CONTAINERS

Lemel Storage and Sorting Boxes



A traditional lemle storage and sorting box kit ideal for your jewellers workshop.

- Lemle Storage Cans and Boxes allow you to control small filings, sweeps and pieces of precious metal in individual carats
- Keeping your lemle sweeps will be efficient with this ideal Four jeweller lemle Storage and Storage Boxes
- Simply hand your lemle cups containers to your jewellers when they finished end of the day. Pour your lemle sweep in to Lemle sieve holder shake and find your precious metal sweeps below.

B8346

Kit contains

- 1 Outer thick gauge steel hammertoe finish case with pad lock facility
- All made for light weight in aluminium
- 2 x Square holding cup trays
- 4 x Lemel sweep cups
- 2 x Lemel sieve holders with lid containers
- 2 x fine hole lemel sieves

B8347

Kit contains

- 1 Outer thick gauge steel hammertoe finish case with pad lock facility
- All made for light weight in aluminium
- 4 x Square holding cup trays
- 8 x Lemel sweep cups
- 4 x Lemel sieve holders with lid containers
- 4 x Fine hole lemel sieves

Code	Description	UOM	Price
B8346	Small Lemel Storage and Sorting Box	EACH	£79.95
B8347	Large Lemel Storage and Sorting Box	EACH	£139.95

STORAGE CABINETS (MULTI DRAWER)

Storage Cabinets (Multi Drawer)



Why buy Raaco?

Raaco has developed and manufactured a unique range of quality storage systems for small items, tools and accessories since 1957. The whole range is based on the same basic values: quality, versatility, functionality and environmental awareness.

All the components in Raaco's storage systems are designed to work together and to save time, space and money. The systems almost unlimited versatility means that it offers an efficient solution for every need. Raaco has long been an international market leader in the development and production of storage systems to the highest professional standards.

Raaco - Robust enamelled steel cabinet & polypropylene drawers with a choice of different drawer combinations manufactured in impact proof plastic. Can stand alone or be wall mounted.

Click website "More Information" for full specification.

Code	Description	UOM	Price
C47818	30 Draw Steel Cabinet	EACH	£19.95
C33830	44 Drawer Steel Cabinet	EACH	£21.95



Online Discounts

BRUSHES

ART BRUSHES

Cousins Range of artist brushes

- These brushes contain the finest natural horse/bristle hair quality.
- Wood handles are made from selected timbers.
- Used by jewellers, silversmiths, model makers, arts/crafts light engineer's sculptors and artists.
- Use these high quality brushes to apply flux or fire coating.
- Durable natural-hair makes the application of flux and other liquids extremely easy and smooth.

Art Brushes



- Pencil Brush ('Polyset')
- Red Lacquered handles
- Soft Hair brush

Dimensions:

- Brush thickness, overall length x brush diameter at ferrule

Code	Description	UOM	Price
B9625A	00 (Extra Fine) 170 x Ø1.50mm	EACH	£1.10
B9625	2 (Fine) 170 x Ø2.40mm	EACH	£1.15
B9624	4 (Medium) 180 x Ø2.50mm	EACH	£1.25
B9623	6 (Thick) 180 x Ø4.00mm	EACH	£1.75
Price breaks available, see website			

Hiqual Art Brushes



Superior quality for fine and delicate work.

- Hiqual Pencil Brush
- Black Lacquered handles
- Gold Synthetic Hair

Dimensions:

- Brush thickness, overall length x brush diameter at ferrule

Code	Description	UOM	Price
B9627	0 (Extra Fine) 160 x Ø2.00mm	EACH	£2.95
B9628	2 (Fine) 160 x Ø2.40mm	EACH	£3.45
B9629	4 (Medium) 170 x Ø2.80mm	EACH	£3.95
Price breaks available, see website			

Sable Hair Art Brush



- Pencil Brush
- Wooden Handles
- Genuine sable hair

Dimensions:

- Brush thickness, overall length x brush diameter at ferrule

Code	Description	UOM	Price
B45714	1 (Fine) 190 x Ø2.00mm	EACH	£0.95
B45715	5 (Medium) 200 x Ø3.30mm	EACH	£0.95
B45716	12 (Large) 220 x Ø6.00mm	EACH	£0.95

BRASS BRUSHES

Brass is a softer wire than stainless steel, and brass brushes are ideal for applications where you do not want to scratch other surfaces. Our brass brushes are made with finest alloy used, and are resistant to rust and corrosion.

Brass Brush Applications

- Satin or lustre finishing
- Surface cleaning
- Burnishing
- Polishing
- Debarring
- Material removal

Brass Scratch Brush



Ideal for cleaning battery contacts, jewellery burrs, drills, taps & dies.

Refills

- B5010 = B0231
- B31640 = Non Refillable

Code	Description	UOM	Price
B5010	Brass Scratch Brush	EACH	£1.95
B31640	Metal Pen Brass Scratch Brush	EACH	£21.95
Price breaks available, see website			

Brass Scratch Brush Refills

- Pack*10
- 44mm long
- 4.30mm neck
- Will fit brush B5010



Code	Description	UOM	Price
B41137	Brass Scratch Brush Refills	PACK*10	£3.85

Brass Scratch Brush Refills, German

- 24pcs
- 44mm long
- 4.30mm neck
- Will fit brush B5010
- Made in Germany



Code	Description	UOM	Price
B0231	Brass Scratch Brush Refills	PACK*24	£11.95



ORDER tracking

Brass Scratch Brush, Flat Style

B4819:

- Made in UK
- Crimped brass
- Sliding neck
- 70 x 25 x 2mm



B6690:

- Bergeon 2272
- Crimped brass
- Sliding neck
- 70 x 25 x 2mm

Code	Description	UOM	Price
B4819	Brass Scratch Brush, Flat Style - Made in UK	EACH	£1.20
B6690	Brass Scratch Brush, Flat Style - Bergeon Swiss	EACH	£8.95

Price breaks available, see website

Hand Held Brass Brushes



Brass Brushes hand held are excellent for pre-polishing an item, removing excess solder from a piece after it has cooled and to achieve a satin 'brushed' metal look.

- It is advised that you use the brush with water and soap as a lubricant when polishing your precious metals to avoid the risk of small parts of brass being deposited from the brush which may give your metal a dull appearance.
- Use fine grade abrasive paper for this type of work also to avoid shiny scratch marks getting a pleasant looking soft shine effect
- Available in a variety of sizes, fine wire grade

Code	Description	UOM	Price
B34949	3 Row Brass Brush	EACH	£1.95
B0219	4 Row Brass Brush, German	EACH	£4.95
B34948	5 Row Brass Brush, Indian	EACH	£1.95
B36655	5 Row Brass Brush, UK	EACH	£4.95
B0220	6 Row Brass Brush, UK	EACH	£7.95
B36656	6 Row Brass Brush, UK	EACH	£4.95

Price breaks available, see website

BRISTLE BRUSHES

We have an ideal range of bristle brushes that will cater for all your cleaning, hand polishing and adhesive applying needs, as well as any other application you can think of!

Available in various shapes/grades, carefully selected for you from all over the globe.

Bench Brush



CousinsUK traditional bench sweeping brushes. Comprising of soft nylon or natural bristles mounted

on a light weight wooden handle, ideal for sweeping your precious metal.

Code	Description	UOM	Price
S39279	Bench Brush, Natural Bristles	EACH	£2.75
B35085	Bench Brush, Nylon Bristles	EACH	£3.40
S39278	Bench Brush, Nylon Bristles - Without Handle	EACH	£2.75

Borax Brush



Jewellery/Silversmith natural horse hair flux brushes.

- Short, light weighted brush specifically made for applying flux when soldering gold, silver, brass, copper etc.
- Completely metal free so no chance of contaminating your solder joints. Often you can find borax brushes with metal crimps holding the hairs, thus causing rust deposits to contaminate the item you are soldering.

Code	Description	UOM	Price
B9630	50mm Borax Brush, Small	EACH	£0.75
B9633	70mm Borax Brush, Medium	EACH	£0.80

Price breaks available, see website

Cleaning Brush



General use cleaning brushes

- Natural or Nylon Bristles
- Plastic or Wooden Handles
- Various Lengths

Code	Description	UOM	Price
S39289	Natural Bristles, Flat Wooden Handle	EACH	£1.50
S39291	Nylon Bristles, Wooden Handle	EACH	£1.50
S39290	Nylon Bristles, Plastic Handle	EACH	£0.95

Dust Off Brush



- Medium bristle

Code	Description	UOM	Price
B9636	Ø10mm Medium Bristle Dust Off Brush	EACH	£1.50
B9637	Ø18mm Medium Bristle Dust Off Brush	EACH	£1.75



WORLDWIDE
DELIVERY

Natural Bristle Brushes, Handheld



Wide section of white natural bristle brushes available in different grades, mounted on natural wooden handle.

- Very soft, soft, medium, medium hard, hard & very hard bristles all available
- 4, 5 or 6 row
- Glasgow, Swisotech Germany, A*F Swiss or Indian

Code	Description	UOM	Price
B51646	Very Soft, Glasgow (4 Row)	EACH	£4.95
B50788	Very Soft, Swisotech (4 Row)	EACH	£4.95
B51645	Soft, Glasgow (4 Row)	EACH	£5.25
B45713	Soft, Indian (4 Row)	EACH	£2.75
B50787	Soft, Swisotech (4 Row)	EACH	£4.95
B51644	Medium Hard, Glasgow (4 Row)	EACH	£5.50
B50786	Medium Hard, Swisotech (4 Row)	EACH	£4.95
B0217	Hard, A*F Swiss (5 Row)	EACH	£8.95
B0216	Hard, A*F Swiss (6 Row)	EACH	£9.50
B51643	Hard, Glasgow (4 Row)	EACH	£5.75
B50785	Hard, Swisotech (4 Row)	EACH	£4.95
B51642	Very Hard, Glasgow (4 Row)	EACH	£5.95
B50784	Very Hard, Swisotech (4 Row)	EACH	£4.95

Nylon Bristle Brushes, Handheld



Wide section of white nylon bristle brushes available in different grades, mounted on natural wooden handle.

- Soft, medium and stiff nylon all available
- 4, 5 or 6 row
- Made in India

Code	Description	UOM	Price
B34944	Soft, 4 Row	EACH	£1.50
B35075	Medium, 6 Row	EACH	£1.50
S39286	Hard, 4 Row	EACH	£1.50
S39287	Hard, 6 Row	EACH	£1.50

Nylon Bristle Brush, Flat Style

- Flat style
- Nylon
- Sliding neck
- 70 x 25 x 2 mm



Code	Description	UOM	Price
B31643	Nylon Scratch Brush Flat Style	EACH	£1.60

Price breaks available, see website

Palate Brush

With moulded plastic unbreakable stocks, they are 9 knot 3/4" diameter brushes with stiff black bristles capable of reaching into the deepest palate.

- Also very useful for finishing cylinders, vases, cups etc.
- Not only you can mount on a normal polishing motor spindles, you can mount it on pendant/flexi cable spindles.
- Use a threaded taper mandrel for pendant drills (code P1345M) and for flexible drive shafts use a pigtail spindle code (C3350).



Dimensions:

- Overall length 55mm
- Bristle length 20mm
- Shank diameter Ø10mm
- Mounting hole diameter Ø4.50mm

Code	Description	UOM	Price
P31641	Ø14mm Palate Brush Black Bristle Extra Stiff	EACH	£1.95
Price breaks available, see website			

Sash Bristle Brush



- America's Salmon Products soft bristle brushes are tapered and finished smoothly whilst comprising a comfortable wooden handle.
- Suitable for fluxing, soldering, applying adhesives, watch and clock cleaning fluids.

Code	Description	UOM	Price
B34120	Ø30mm Sash Brush (Number 16)	EACH	£3.95
Price breaks available, see website			

Surgeon's Hand Scrub Brush

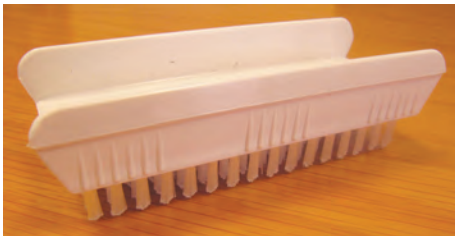

A very handy cleaning brush to thoroughly clean your hands, fingers and whatever you dare after a hard day at work in your workshop. Particularly excellent to clean out the dirt from under your fingernails.

- White nylon bristles
- Size: 104 x 40 x 32mm
- Autoclavable

Code	Description	UOM	Price
B31642	Surgeon's Hand Scrub Brush	EACH	£1.95
Price breaks available, see website			

Aging Chemicals

See Page 1232



Wash Out Brushes

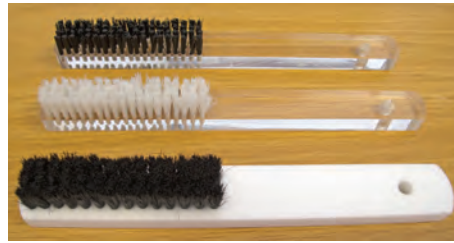

Very useful for cleaning ultrasonic tanks and other equipment and tools.

Also Ideal for cleaning out polishing composition and second hand jewellery/watches, particularly behind a stone set piece if one does not have an ultrasonic at hand. Simply run water from your tap over your item and because of the unique stiff bristles, it will clean into the most intricate spaces.

- Hand held
- Plexi glass handles (clear or white)
- Nylon bristles
- Hard or soft bristles
- 4 or 3 rows
- Washout
- Mad in India

Code	Description	UOM	Price
B35076	Hard Bristle Brush (4 Row), Clear Handle	EACH	£3.50
S39288	Soft Bristle Brush (4 Row), Clear Handle	EACH	£3.95
B46143	Soft Bristle Brush (3 Row), White Handle	EACH	£3.95

FIBREGLASS SCRATCH BRUSHES

Fibre Glass Scratch Brushes are very useful in your workshop and have a wide number of applications:

- Available in many shapes & styles with refills readily available.
- Ideal for surface cleaning and removing corrosion on watch battery contacts.
- Can use before precious metal acid testing, removing suspected plate metal.
- Create a unique texturing effect, just like many contemporary artists and jewellery makers do.
- A quick test for diamonds, if the brush scratches it, then it isn't real.
- Please note one should take care when using not to run on skin as fine hairs may penetrate causing discomfort.

Scratch Brush, Cousins Set



This is an excellent set consisting of the 3 main brushes any watch or clock maker or jeweller could need. All

with a comfortable plastic body, colour coded for ease of use.

- Fibreglass scratch brush: A wide range of uses, including removing suspected plate metal before acid testing, creating a unique texturing effect or a quick test for checking if a diamond is real
- Brass scratch brush: Ideal for cleaning battery contacts, jewellery burrs, drills, taps & dies
- Steel scratch brush: Excellent for removing oxidation marks off harder metals
- 120mm long

Refills:

- Brass: Code B41137
- Fibreglass: Code B41138
- Steel: Code B41138

Code	Description	UOM	Price
B35083	Scratch Brush Set	PACK*3	£2.90

Scratch Brush, Cousins



Fibreglass Scratch Brush - Cousins

- Popular Pen Type
- 12cm Length
- Refill Pack B0230

Propelling pencil action exposes more of the glass fibres. The shorter the fibres showing the more abrasive the action.

Code	Description	UOM	Price
B0226	Fibreglass Scratch Brush	EACH	£1.45

Scratch Brush, Bergeon



Fibreglass Scratch Brush - Bergeon 2834C

- Bergeon Swiss
- Popular Pen Type
- 12cm Length
- Refill Pack B0230

Code	Description	UOM	Price
B0225	Bergeon 2834C Fibreglass Scratch Brush	EACH	£8.75

Scratch Brush Refills

- 10 pieces
- Popular Pen Type
- 40mm Long x 4.3mm Neck
- Standard Type



Code	Description	UOM	Price
B41136	Glass Scratch Brush Refills	PACK*10	£3.50

Scratch Brush Refills, German

- 24 pieces
- Popular Pen Type
- 40mm Long x 4.3mm Neck
- Standard Type
- Made in Germany



Code	Description	UOM	Price
B0230	Glass Scratch Brush Refills	PACK*24	£8.95

Scratch Brush, Narrow, Cousins

- Pen Type Ø7mm
- 2mm Nib
- 5cm Long
- Refills = B0224

Same applications as larger brushes but for use on smaller and less accessible areas.

Code	Description	UOM	Price
B0223	Fibreglass Scratch Brush, Narrow	EACH	£5.25

Scratch Brush, Narrow Refills, Cousins

- 12 pieces
- Ø2mm
- Narrow Pen Type

Code	Description	UOM	Price
B0224	Glass Scratch Brush Refills Ø2.0mm	PACK*12	£7.75

Scratch Brush, Roped

These 180mm long brushes are for use on larger areas. To expose more fibres, simply pull back the string. We recommend that you use insulation tape around the brush to avoid getting fibre glass splinters.

- Various diameters available.

Code	Description	UOM	Price
B0228	Ø10mm Glass Fibre Scratch Brush	EACH	£6.95
B36962	Ø17mm Glass Fibre Scratch Brush	EACH	£7.95
B50529	Ø20mm Glass Fibre Scratch Brush	EACH	£8.95
B50530	Ø25mm Glass Fibre Scratch Brush	EACH	£9.95

embedded filings far more effectively than an ordinary wire brush.

- 2 brushes
- Hand brush & card brush
- Plastic handles
- High quality
- Faithful tools

Size and weight:

- Card brush: 230mm overall length
- Hand brush: 205mm overall length

Code	Description	UOM	Price
B49982	File Brush Kit	PACK*2	£5.90

STEEL BRUSHES**Medium Steel Cleaning Brush**

- Crimped medium firm
- 14cm long overall

Code	Description	UOM	Price
B9635	Steel Cleaning Brush Crimped Medium Firm	EACH	£5.90

Hard Steel Cleaning Brush

- 4 Row
- Firm Tines
- 31cm long overall

Code	Description	UOM	Price
B9634	Steel Wire Brush 4 Row Firm Tines	EACH	£3.30

Steel Scratch Brush Refills

- Pack*10
- Popular Pen Type
- 40mm Long x 4.3mm Neck
- Standard Type



Code	Description	UOM	Price
B41138	Steel Scratch Brush Refills	PACK*10	£2.90

Online Discounts

Aprons (Denim or Suede)

See Page 1003

**CLOCK SPECIFIC****BEAT SETTING****Beat Setting (Clock) Tool, Horolovar**

- For 400 day anniversary clocks

With this tool, the final and most important operation in a 400 day clock repair, is putting the pendulum in beat.

This becomes simple, quick, accurate and permanent, moreover it can be used on any model 400 day clock suspension saddle, old or new.

This precision tool is expressly designed to make the day to day life of a clock repairer easier and more profitable.

Code	Description	UOM	Price
T5058	Horolovar Beat Setting Tool	EACH	£17.45

BUSHING TOOLS**A*F Swiss "Screw In" Bushing Tool**

- AF Switzerland 17920.75
- Complete tool with assortment of 75 bushings (B19469)
- Used for bushing clock main plates without dismantling the movement

Supplied in the pack:

- (G) Frame and carriage - No. 17920G
- (P) Pointer - No. 17920P
- (F) Cutter - No. 17920F Ø4.50mm
- (T) Tap - No. 17920T
- (C) Bushing Key - No. 17920C
- (PB) Bushing Holder - No. 17920PB
- (M) Handle - No. 17920M

Instructions:

1. Loosen the carriage (G) so that it moves freely on the guide rails of the tool. Fit the tool to the edges of the clock main plate without clamping tightly.
2. Insert the pointer (P) in the brass guide hole (H) on the carriage and position the tip exactly over the wheel pivot by moving the carriage and the tool. (Fig 2)
3. Fix the carriage by tightening the screw and firmly clamp the complete tool to the edges of the main plate.
4. Remove the pointer and lubricate the guide hole.

FILE CLEANING BRUSH**File Cleaning Brush**

FAITHFULL
QUALITY TOOLS



Used for cleaning metal and wooden files, removes

5. Fit the hollow cutter (F) to the wooden handle (M) and cut a circular hole around the pivot by pressing and turning the handle. (Fig 3)
6. Remove the cutter and replace with the tap (T) and thread the hole. (Fig 4)
7. Loosen the screws and remove the tool from the plate.
8. Push the wheel pivot up through the hole and select a suitable size bush by holding in the bush holder (PB). If the bush hole needs enlarging this can be done by reaming out while held in the holder. (Fig 5)
9. Screw the bush into position with the key (C). (Fig 6)
10. Lock in the plate by centre popping the plate close to one of the niches. (Fig 7)

Click website "More Information" for full specification.

Code	Description	UOM	Price
B19465	Screw In Bush Clock Bushing Tool	EACH	£295.00
R19477	Tool Cutter Ø4.50mm (F)	EACH	£25.95
R19472	Tool Cutter Ø5.20mm (F1)	EACH	£26.15
K19959	Tool Key (C)	EACH	£18.95
T35882	Tap for Bushing Tool (T)	EACH	£28.95

Bergeon 16200 Complete Set



New improved version

- Bushing tool that allows the centring, milling and reaming of clock plates
- Can remove and set brass or bronze bushings (including on very large clocks such as "comtoise" or "Morbier" clocks).
- Black anodized aluminium frame
- Can hold plates from 50 to 220mm
- Practical for all clocks, from mantel clocks to grandfather clocks
- 355 x 355 x 180mm
- Bergeon 16200

Tool includes:

- Complete tool frame
- 10 Reamers: Ø1.27, 1.97, 2.47, 2.97, 3.47, 4.47, 5.47, 6.47, 7.47 & 8.47mm
- 4 Drilled stakes: Ø8 x 3, 10 x 5, 16 x 8 & 30 x 10mm (stake x hole)
- 3 Driving punches: Ø3, 6 & 9mm
- 1 Centring bit
- 2 Centring stakes: Ø16 x 4 & 16 x 9mm (stake x point)
- 1 Undrilled stake: Ø25mm
- 2 Chamfering tools: Ø4 & 10mm
- 5 Pivot cutters: Ø2.20 x 0.40, 3.00 x 0.70, 5.00 x 1.50, 6.00 x 3.00 & 9.00 x 5.00mm (cutter x pivot)
- 1 Jacob chuck: Opening 0 to 4mm

Code	Description	UOM	Price
B0290	Bergeon 16200 Bushing Tool Complete Set	EACH	£995.00

Bergeon 16200R Reduced Set



New improved version

- Bushing tool that allows the centring, milling and reaming of clock plates
- Can remove and set brass or bronze bushings (including on very large clocks such as "comtoise" or "Morbier" clocks).
- Black anodized aluminium frame
- Can hold plates from 50 to 220mm
- Practical for all clocks, from mantel clocks to grandfather clocks
- 355 x 355 x 180mm
- Bergeon 16200R

Reduced set, includes:

- Complete tool frame
- 10 Reamers: Ø1.27, 1.97, 2.47, 2.97, 3.47, 4.47, 5.47, 6.47, 7.47 & 8.47mm
- 1 Chamfering tool: Ø4mm
- 4 Drilled stakes: Ø8 x 3, 10 x 5, 16 x 8 & 30 x 10mm (stake x hole)
- 3 Driving punches: Ø3, 6 & 9mm
- 1 Centring bit
- 1 Centring stake: Ø16 x 9mm (stake x point)
- 1 Undrilled stake: Ø25mm

Code	Description	UOM	Price
B0291	Bergeon 16200R Bushing Tool Reduced Set	EACH	£750.00

Bergeon 6200E Full Accessory Set



Comprising all components of Bergeon 16200 complete tool (B0290).

Code	Description	UOM	Price
B4929	Bergeon 6200E Bushing Tool Full Accessory Set	EACH	£520.00

Centring Bit, Bergeon

- Bergeon 6200.06
- For 16200 & 16200R bushing tools.



Code	Description	UOM	Price
B9560D	Centring Bit For Bergeon Bushing Tool	EACH	£7.50

Centring Stakes, Bergeon

- Bergeon 6200.12 & 6200.13
- For 16200 & 16200R bushing tools.
- Size given is the point diameter
- Ø16mm stake



Code	Description	UOM	Price
B48324	Ø4.00mm Centring Stake, Bergeon 6200.12	EACH	£25.50
B48325	Ø9.00mm Centring Stake, Bergeon 6200.12	EACH	£18.95

Cutters (chamfering), Bergeon

Chamfering cutters for 16200 & 16200R bushing tools.



Code	Description	UOM	Price
B0277	Ø4mm Chamfering Bit, 6200.24	EACH	£13.85
B0278	Ø10mm Chamfering Bit, 6200.25	EACH	£17.50

Cutters (pivot/rose), Bergeon

Pivot/rose cutter for 16200 & 16200R bushing tools.



Code	Description	UOM	Price
B0279	Ø2.20mm Pivot/Rose Cutter 6200.26	EACH	£29.95
B0280	Ø3.00mm Pivot/Rose Cutter 6200.27	EACH	£29.95
B0281	Ø5.00mm Pivot/Rose Cutter 6200.28	EACH	£30.95
B0282	Ø6.00mm Pivot/Rose Cutter 6200.29	EACH	£30.95
B0283	Ø9.00mm Pivot/Rose Cutter 6200.30	EACH	£32.95

ONLINE F.A.Q.

PRICE PROMISE GUARANTEE

Driving Punches, Bergeon

Chamfering cutters for Bergeon 16200 and 16200R bushing tools.



Code	Description	UOM	Price
B9560A	Ø3.00mm Driving Punch, Bergeon 6200.03	EACH	£9.25
B9560B	Ø6.00mm Driving Punch, Bergeon 6200.04	EACH	£9.25
B9560C	Ø9.00mm Driving Punch, Bergeon 6200.05	EACH	£9.25

Handle for Bushing Tool, Bergeon

Handle for 16200 & 16200R bushing tools

Includes top wheel, centre shaft & spring



Code	Description	UOM	Price
B55086	Handle for Bushing Tool, Bergeon 16200.01	EACH	£69.95
B56314	Grub Screw for Handle, Bergeon	EACH	£0.95

Jacob's Chuck & Key, Bergeon



• Bergeon 6200.31
Chamfering cutters for Bergeon 16200 and 16200R bushing tools.

Code	Description	UOM	Price
B0284	Jacob's Chuck & Key For Bergeon Bushing Tool	EACH	£129.95

Reamers (by size), Bergeon

• Size given is the largest cutting diameters
• Ø1.78 & Ø3.97mm reamers are specifically designed and sized for Morbier and Comtoise clock bushings



Code	Description	UOM	Price
B0267	Ø1.20mm Reamer 6200.14	EACH	£12.75
B0285	Ø1.78mm Reamer 6200.51	EACH	£21.25
B0268	Reamer 6200.15 Ø1.97mm	EACH	£12.90
B0269	Ø2.47mm Reamer 6200.16	EACH	£12.90
B0286	Ø2.68mm Reamer 6200.52	EACH	£21.25

B0270	Ø2.97mm Reamer 6200.17	EACH	£12.90
B0271	Ø3.47mm Reamer 6200.18	EACH	£12.90
B0287	Ø3.97mm Reamer 6200.56	EACH	£21.25
B0272	Ø4.47mm Reamer 6200.19	EACH	£13.85
B0273	Ø5.47mm Reamer 6200.20	EACH	£13.85
B0274	Ø6.47mm Reamer 6200.21	EACH	£13.85
B0275	Ø7.47mm Reamer 6200.22	EACH	£13.85
B0276	Ø8.47mm Reamer 6200.23	EACH	£14.75

Reamers (sets), Bergeon



B0288 - K Series Reamers, Bergeon 6200F
• Set of 5 Extra Reamers
• Specific sizes to deal with Bergeon 'K' Range of bushes
• Ø1.78, 2.68, 4.66, 5.85, 8.64mm

B0289 - Intermediate Reamers, Bergeon 6200G
• Set of 5 Intermediate Reamers
• Specific sizes to deal with larger clocks
• Ø3.97, 4.97, 5.97, 6.97, 7.97mm

Code	Description	UOM	Price
B0288	K Series Reamers, Bergeon 6200F	EACH	£112.95
B0289	Intermediate Reamers, Bergeon 6200G	EACH	£113.95

Reamer Handle



• Handle for holding Bergeon reamers
• Knurled handle
• Steel construction
• Includes hex wrench for tightening
• Made in USA

Dimensions:
• 115 x Ø15mm (Overall length x diameter)

Code	Description	UOM	Price
R55771	Handle for Bergeon Reamers, USA	EACH	£16.95

Spring for Centre Shaft



• Spring for Centre Shaft
• For 16200 & 16200R bushing tools
• Bergeon Swiss

Code	Description	UOM	Price
B52355	Spring for Centre Shaft	EACH	£3.35

Stakes, Bergeon



• Stakes, drilled and undrilled
• For 16200 & 16200R bushing tools
• Bergeon Swiss

Dimensions:
• Stake diameter Ø x hole diameter Ø

Code	Description	UOM	Price
B48327	Undrilled Stake, Bergeon 6200.07	EACH	£11.95
B48328	Ø8 x 3mm Stake, Bergeon 6200.08	EACH	£11.95
B48329	Ø10 x 5mm Stake, Bergeon 6200.09	EACH	£11.95
B48330	Ø16 x 8mm Stake, Bergeon 6200.10	EACH	£11.95
B48331	Ø30 x 10mm Stake, Bergeon 6200.11	EACH	£11.95

CENTRE NUT TOOLS

Centre Nut Fixing Tools

• For Quartz Clock Movements
• Very effective tools to loosen & tighten the centre mounting nuts on quartz and other battery clock movements
• Tools can be and may need to be filed & modified to fit the varying different makes of quartz clock movements
• See website "more info" for further specifications

Centre Nut Fixing Tool, Adjustable



• Centre nut fixing tool
• Butterfly type
• 2 different types of tips
• Capacity 0 to 40mm
• Adjustable with locking mechanism
• For right or left hand
• Stainless Steel
• Inexpensive to replace if lost
• Tool can be filed to fit as required

Code	Description	UOM	Price
C39633	Centre Nut Fixing Tool, Adjustable	EACH	£2.95

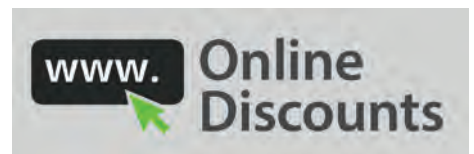

Centre Nut Fixing Tool with Plastic Handle



- Good grip
- Length 135mm
- Handle Grip Ø25mm
- Tool can be filed to fit as required

Code	Description	UOM	Price
S32056	Centre Nut Fixing Tool with Plastic Handle	EACH	£1.75

Centre Fixing Nut Tool with Wooden Handle



- Good grip
- Length 145mm
- Handle Grip Ø25mm
- Tool can be filed to fit as required

Code	Description	UOM	Price
J56086	Centre Fixing Nut Tool with Wooden Handle	EACH	£5.75

Centre Nut Fixing Tool with Multiple Ends



- 4 different size ends
- 75 x 75mm
- Sturdy handheld design
- Tool can be filed to fit as required

Code	Description	UOM	Price
K31257	Centre Nut Fixing Tool with Multiple Ends	EACH	£4.25

CROWS FOOT

Crows Foot



A "must" for all clock repairers

- Fits into a vice or bench block, handy for removing all friction wheels & gears
- Oxidation resistant steel
- Weight 145g

Code	Description	UOM	Price
C31268	Clock Crows Foot	EACH	£6.95

HAIRSPRING HOLDER

Clock Hairspring Holder

Clock Hairspring Holder

- Simple basic tool for holding hairspring whilst adjusting or amending
- Weight 10g



Code	Description	UOM	Price
H31258	Clock Hairspring Holder	EACH	£3.75

REMOVING & ADJUSTING, CLOCK

Clock Hand Collet Adjusting Tool

Round Clock Hand Collet Adjusting Tool



- Round Tip
- Tip 1 to 4mm
- Wooden Handle
- This tool is normally used for the adjustment of the bushing for hermlé hands.

Hermle movements can strike a few minutes before or after the hour instead of directly on the hour to correct this you simply put the tool through the minute hand bush and rotate the hand slightly so the clock strikes exactly on the hour.

Code	Description	UOM	Price
B19167	Round Clock Hand Collet Adjusting Tool	EACH	£2.75

Square Round Clock Hand Collet Adjusting Tool



- Square Tip
- Tip 1 to 6mm
- Red Plastic Handle
- This tool is normally used for the adjustment of the bushing for hermlé hands.

Hermle movements can strike a few minutes before or after the hour instead of directly on the hour to correct this you simply put the tool through the minute hand bush and rotate the hand slightly so the clock strikes exactly on the hour.

Code	Description	UOM	Price
B19168	Square Round Clock Hand Collet Adjusting Tool	EACH	£3.95

Clock Hand Removing Levers



Bergeon 30032.04 - Swiss Made

For clocks and alarm clock. In specular polished hardened steel work surfaces. Mirror finished tips with knurled handles.

- Tip width: 15m
- Length: 210mm
- Weight 120gm

Code	Description	UOM	Price
H7351	15mm Wide, Bergeon 30032.04	PAIR	£89.95

Clock Hand Removing, Screw Pressure

Hand Removing for clocks. Hands are removed by screw pressure.

Clock Hand Remover

- Indian
- D-Shape
- Weight 20gms



Code	Description	UOM	Price
H31259	Clock Hand Remover	EACH	£2.65



Clock Hand Remover

- Economy
- Indian
- G-Shape



Code	Description	UOM	Price
H32055	Clock Hand Remover	EACH	£4.95

Clock Hand Remover, Bergeon 30002

Clock Hand Remover

For clocks and alarm clocks, comes with two blades Large and small.

- Bergeon 30002
- Swiss Made



Code	Description	UOM	Price
H0788	Clock Hand Remover, Bergeon 30002	EACH	£30.95

Blade (large) Bergeon 30002A

Clock Hand Remover Replacement Blade - Large

- Bergeon 30002A
- Swiss Made



Code	Description	UOM	Price
H0789	Blade (large) Bergeon 30002A	EACH	£3.95

Blade (small) Bergeon 30002B

Clock Hand Remover Replacement Blade - Small

- Bergeon 30002B
- Swiss Made



Code	Description	UOM	Price
H0790	Blade (small) Bergeon 30002B	EACH	£3.95

HOLE CLOSING & RIVETING PUNCHES

Hole Closing & Riveting Clock Punches

- For clock plates (retracting self centring pin)
- Set of 7 closing punches for worn pivot and shaft holes where re-bushing is inappropriate
- Suitable for small or large clocks with brass plates

Hole Closing Punches, Set of 7

- For clock plates (retracting self centring pin)
- Set of 7 closing punches for worn pivot and shaft holes where re-bushing is inappropriate
- Suitable for small or large clocks with brass plates
- Supplied in a wooden box
- Weight 155g
- Made in India



Punch sizes (locating pin diameter at widest point x punch diameter):
 • Ø0.90 x 3.30, 1.20 x 3.65, 1.20 x 3.85, 1.65 x 3.90, 1.80 x 4.75, 2.00 x 5.65 & 2.70 x 5.80mm

Code	Description	UOM	Price
P20879	Hole Closing Punches, Set of 7	EACH	£24.95

Clock Punches & Riveting Stake Set



- 13 Hole Stake
- 16 Punches Ø1.40mm to 5.00mm (Flat and Domed plus 2 Hole Closing Punches)
- Wooden Stand (85mm x 120mm)

Code	Description	UOM	Price
P32054	Clock Punches & Riveting Stake Set	EACH	£33.95

KEY GAUGE

Clock Key Gauge



- Metric Sizes: 1.75mm to 6.00mm
- Imperial Numbers: 000 to 15

• 18 Sizes

Code	Description	UOM	Price
G32018	Clock Key Gauge	EACH	£11.95

MAINSRING LET DOWN & WINDERS

Mainspring Winder, Bergeon



Bergeon 4126 - Swiss Made

Clock mainspring winder comprises frame and crank with reversible ratchet device, 3 hooks and one double pin post for coiling spring to desired diameter before fitting. (Vice not included).

- For clock mainsprings for French & German clocks
- Uses the barrel arbor to wind the mainspring
- With pawl to ensure winding in either direction
- Distance between arbor and support is 19mm (see additional image)
- 180 x 100 x 30mm (length x height x width)
- 1.5Kg

Instructions for use:

- Hook the centre (inside) of the mainspring to the centre shaft arbor
- Hook the outside (the end) of the mainspring to the top shaft support
- Begin to wind in the direction required, lightly pushing down the top shaft to support the coils being formed
- Wind to desired diameter, gradually increasing the force on the top shaft to keep the forming coils tight
- Slide the clock barrel over the coiled mainspring

Code	Description	UOM	Price
M0954	Bergeon 4126 Clock Mainspring Winder	EACH	£136.75
M55239	Double Ended Pin	EACH	£10.95
M55240	6mm Hook Attachment	EACH	£10.95
M55241	9mm Hook Attachment	EACH	£10.95
M55242	12mm Hook Attachment	EACH	£10.95

Mainspring Winder, Ollie Baker Style



Clock Mainspring Winder - Ollie Baker Style

- Ollie Baker style clock mainspring winder
- For both hole and loop end mainsprings
- Includes 9 different size mainspring sleeves

- Left and right turning handle with heavy duty steel ratchet and pin system for sure and safe locking
- 3 different size mainspring end holders cater for all sizes of mainspring
- Aluminium frame
- Can be screwed to your bench or used in a vice
- See video link above for demonstration
- Made in USA

Mainspring sleeve sizes (inside diameter):

- Ø22, 25, 28, 31, 35, 38, 41, 44 & 54mm

Code	Description	UOM	Price
M52133	Mainspring Winder, Ollie Baker Style	EACH	£199.95

Mainspring Let Down Tool, Bergeon



Bergeon 2301 - Swiss Made

Key to let down and wind up clock mainsprings.

Contains:

- 1 chuck holder fitted with a rubber handle
- 24 numbered chucks with winding squares from No 000 to 21 (Ø1.75 to Ø7.50 mm)
- Steps of 0.25 mm
- 1 special winding chuck for alarm clocks
- 1 removable metal handle
- In wooden case

Instruction for use

- For let down a mainspring

Choose the chuck corresponding to the winding square arbor and fix it to the tool. Put the tool into the square arbor. Exert a firmly pressure on the rubber cylinder. Turn slightly the tool clockwise. Lift up the click with the left hand. Let down by progressively releasing grip, so that the rubber cylinder slowly rubs on the tool.

- For winding up mainsprings

Choose the chuck corresponding to the winding square arbor and fix it to the tool provided with the metal handle. Wind up as with a normal key.

Code	Description	UOM	Price
M0887	Bergeon Clock Mainspring Let Down Tool	EACH	£885.00

Mainspring Let Down Tool



Mainspring let down tools are used to safely unwind your clock's powerful mainspring, so that you may disassemble the movement for proper cleaning and lubrication without injuring yourself and causing extensive damage to the movement.

A clock key goes into the chuck and the chuck goes into the handle so you can let down the power of the

spring. It does the same job as the let down tool with all the chucks as it can hold various sizes of key

- Can hold multiple sizes of key
- Maximum key handle width (to fit in the chuck) 1.50mm
- Durable plastic handle
- Double ended key shaft made from quality steel
- Key supplied separately

Code	Description	UOM	Price
M41162	Mainspring Let Down Tool	EACH	£11.95

Mainspring Let Down Tool with 3 Key Shafts



Mainspring let down tools are used to safely unwind your clock's powerful mainspring, so that you may disassemble the movement for proper cleaning and lubrication without injuring yourself and causing extensive damage to the movement.

- Durable plastic handle
- Double ended key shafts made from quality steel
- 3 double ended key shafts: No.5, 6, 7, 8, 10 & 12
- Hexagonal handle fitting 11mm

Code	Description	UOM	Price
M41163	Mainspring Let Down Tool with 3 Key Shafts	EACH	£15.95

Mainspring Let Down Tool with 6 Key Shafts, Cousins



Permits confident release of mainspring power prior to disassembly, shafts hold firmly in the solid resinous holder.

Contains:

- Set of six precision double ended steel key shafts
- Universal holder

Imperial clock key sizes:

- 12 popular sizes included; 2/3, 4/5, 6/7, 8/9, 10/11 & 12/14.

Made in UK

Code	Description	UOM	Price
L6478	Mainspring Let Down Tool with 6 Key Shafts, Cousins	EACH	£75.00
H12039	Handle only for Cousins Let Down Tool	EACH	£5.95

Rivot End Mainspring Winder



Clock - Rivot End - Mainspring Winder

1. Insert the main wheel and winding arbor in the tool.
2. Clamp the main wheel to the tool.
3. Hook the loop end of the mainspring over the short outside pin.
4. Wind from the bottom with a key.
5. Insert a mainspring clamp over the mainspring once it is wound to the required diameter.
6. Wear protective glasses and gloves.

Code	Description	UOM	Price
M31427	Clock Mainspring Winder for Rivot End Mainsprings	EACH	£5.95

MICROPHONES FOR CLOCK TESTING

Clock Clamping Microphone, Greiner



Greiner B600 - Mechanical Clock Pick-Up Microphone

Sensor, grip and flex cable for attaching to platform escapement clocks or similar. Not suitable for pendulum clocks.

Code	Description	UOM	Price
T8838B	Greiner B600 Mechanical Clock Pick-Up Microphone	EACH	£204.00

Clock Clamping Microphone, Witschi



Clock Clamping Microphone - Witschi

For Elma & Witschi:
• Watchmatic 2 & 3

- Watch Expert 2 & 3
- Chronoscope M1, S1 & X1

Simply plugs in and then attaches by a small clip close to the escapement area on the clock - to sense escapement action and transmit data to the graph screen for analysis.

Code	Description	UOM	Price
T12050	Elma Watchmatic & Witschi Watch Expert II & III' Clock Clamping Microphone	EACH	£239.95
T6249	Elma Watchmatic & Witschi Watch Expert I' Clock Clamping Microphone	EACH	£160.00

Clock Pendulum Sensor & Stand, Witschi



Optical Electronic Sensor & Stand - Elma & Witschi

T12038 for Elma & Witschi Equipment:

- Witschi Watch Expert 2
- Witschi Watch Expert 3
- The Watch Expert (Witschi Watch Expert 4)
- Witschi Chronoscope M1
- Witschi Chronoscope S1 (any generation)
- Witschi Chronoscope X1 (any generation)
- Elma Watchmatic 2
- Elma Watchmatic 3

T9676 for Elma & Witschi Equipment:

- Witschi Watch Expert 1
- Elma Watchmatic 1

This sensor device records the pendulum passing through its beam to analyse performance of timekeeping and then displays the transmitted data on the equipment screen.

A multi-positional stand is available as an option to assist test procedure and set up (see T9677). Picture here shows the opto-electronic sensor connected to the optional positional support stand.

Photo shows Sensor attached to Stand - both items sold separately.

Officially Appointed Witschi & Elma Distributor

Code	Description	UOM	Price
T12038	Clock Pendulum Electronic Sensor for Elma & Witschi	EACH	£435.00
T9676	Clock Pendulum Electronic Sensor for Elma & Witschi	EACH	£350.00
T9677	Stand for Optical Clock Pendulum Electronic Sensor	EACH	£145.00



SAME DAY DISPATCH

MOVEMENT HOLDERS

Assembly Leg Movement Clamps

These robustly made Movement Clamp legs hold the job away from the bench to clear protrusions and make inspection, pivot locating and strike assembly much easier.



- 3 pieces
- Solid brass and steel with non-slip feet
- Wired securely the tripod doubles as a temporary wall/ test hanger
- Made in UK

Code	Description	UOM	Price
C6477	Leg Clock Movement Clamps	PACK*3	£13.95

Assembly Movement Supports



- Support your clock movement during repair
- Provides easy access to all areas of the movements
- Assortment of sizes and supports
- Legs clamp to each corner of the movement
- Supplied with a hanging bracket for movement testing
- Including 4 clock movement legs

Code	Description	UOM	Price
A41165	Assembly Supports for Clock Movements	EACH	£9.95

Wall Mounted, Bergeon 30044

Clock Movement Holder - Bergeon Swiss - Wall Mounted

The REALIS clock timing stands are simple, robust and practical. No more waste of time, insecurity, wrong suspension springs. Absolute stability of the movement during timing. Holder made of carefully polished beechwood. It is jointed and adjustable. Clock movements are not held by the bottom but they are hung. This very practical stand will hold all types of round and square movements of current sizes. Height: 360 - 450 mm.



- Bergeon 30043
- Made of beech wood
- Jointed
- Adjustable
- Holds Round or Square Movements
- Various test positions
- For fixing to the wall

- Total height 36 - 45cm

Code	Description	UOM	Price
M0983	Movement Holder (Clock), Bergeon 30044	EACH	£59.85

Bench Top, Universal

- Universal Clock Movement Holder
- Strong & robust
- Regulating / Levelling screw on base
- Brackets are adjustable to 11 inches
- Overall height 370mm



Code	Description	UOM	Price
S32057	Mechanical Pendulum Clock Regulating Stand	EACH	£29.95

PALLET ADJUSTMENT TOOLS

Clock Pallet Adjustment Tool



Clock Pallet Adjustment Tool

- Tool which allows you to precisely grind & shape clock pallets
- Also useful for screw heads, bridges etc
- 48 x 43 x 34mm
- Bergeon 30444

Code	Description	UOM	Price
C50409	Pallet Adjustment Tool	EACH	£89.95



WORLDWIDE DELIVERY

www.

Online Discounts

PRICE PROMISE GUARANTEE

PIVOT POLISHING MACHINE

Rollimat Clock Pivot Polishing Machine



Rollimat Clock Pivot Polishing Machine

The Rollimat clock pivot polisher is a tool that allows you to polish any clock pivot with ease in minutes

- Will polish all pivots from Ø0.30 to Ø4.00mm in diameter
- Minute gear pivots (pocket or wristwatch), anchor pivots and even plastic pivots
- Holder with 24 bearings & a Widia brand polishing disc
- A depth-limiter guarantees that the pivot will be rolled to the dimension set
- The adjustable pressure imposed is created by a steel spring
- Machine can be lubricated with 3 in 1 oil (O8691)
- See PDF for full instructions
- Product video available (see link above)
- Requires plug adapter A32444
- 220 to 240 Volt (230 to 110 volt converter please see our code A52044)
- Made in Germany

Dimensions:

- 270 x 100 x 225mm (height x width x depth)
- 5Kg

Code	Description	UOM	Price
R48824	Rollimat Clock Pivot Polishing Machine	EACH	£2,250.00
R48825	Ø4mm Widia Polishing Wheel	EACH	£315.00
R48826	Drive Belt	EACH	£9.95
R48827	Felts	EACH	£2.50
R55828	Upper Bearing for Rollimat	EACH	£78.95

PIVOT TO HOLE LOCATING

Large Clock Pivot Locating Tool



- Clock Pivot Locating Tool
- 190mm (7 1/2") Overall Length (including wooden handle)
- Reach for larger stubborn pinions

Code	Description	UOM	Price
P8784	Large Clock Pivot Locating Tool	EACH	£2.90

Standard Clock Pivot Locating Tool



- Clock Pivot Locating Tool
- 160mm (6 1/4") Length
- Reach for general use throughout the clock train

Code	Description	UOM	Price
P8783	Standard Clock Pivot Locating Tool	EACH	£2.65

COMPRESSORS & ACCESSORIES

Bambi 35/20 Compressor *Free delivery to UK mainland*



Ultra high performance with ultra low noise. Designed for applications demanding the highest quality air supply at the lowest noise levels. At the heart of the design is the fitted piston rings which eliminate oil carry over to the air supply, giving perfect air quality every time

Suitable for equipment such as:

- Bergeon 5555-10
- Elma Spheric
- Elma Steam Cleaner - Air Jet Option
- Greiner Poseidon LT-100
- Witschi Proofmaster M
- Witschi Proofmaster S
- Calypso Wet Tester

Specifications:

- Specially adapted 10 bar operation with 12 bar cut out (8 Bar Version Pictured)
- 10 Bar Version comes with T-Bar Filter Pressure Regulator
- 50 litres per minute
- 4 Litre reservoir
- Quiet running motor
- Quality build for reliability
- No exposed moving parts
- Fitted with piston rings eliminating oil carry over to the air supply
- Fully guaranteed
- Has a 1/4 inch BSP (British Standard Pipe) female fitting
- Supplied with 1 litre bottle of Compressor oil (C1837A)
- Free Delivery to UK Mainland (please place your order selecting a carriage method as usual. The carriage charge will be removed once the order is placed)
- Mains operated
- Usually delivers within 1 to 2 days from date of order
- Bambi 35/20

Dimensions:

- 35 x 28 x 35cm (H x D x W)

Code	Description	UOM	Price
C1837	Bambi 35/20 Compressor *Free delivery to UK mainland*	EACH	£685.00

Bambi BB15V Compressor

A budget compressor that has been developed for those users where ultra low noise and high performance is essential. With extra low noise and virtually no vibration, this unit is perfect for any work area



- 8 Bar operation
- 50 litres per minute
- 15 Litre reservoir
- Low noise air compressor
- Compact design with no exposed moving parts
- Mains operated (220-240/50hz)
- Has a 1/4 inch BSP (British Standard Pipe) female fitting
- Free delivery to UK mainland (please place your order selecting a carriage method as usual. The carriage charge will be removed once the order is placed)
- Supplied with 1 litre bottle of Compressor oil (C1837A)
- Usually delivers within 1 to 2 days from date of order
- Bambi BB15V

Dimensions:

- 47 x 37 x 37cm (H x W x D)

Code	Description	UOM	Price
C12606	Bambi BB15V Compressor *Free delivery to UK mainland*	EACH	£385.00

Bambi Compressor Connector

Bambi Compressor Connector



- Will connect a Ø6mm tube to our Bambi compressors
- Will fit a 1/4 inch BSP (British Standard Pipe) female fitting

Code	Description	UOM	Price
C41895	Bambi Compressor Connector	EACH	£8.50

Bambi Compressor Oil

Bambi Compressor Oil

- For model 35/20 & BB15V (C1837 & C12606)
- 1 Litre



Code	Description	UOM	Price
C1837A	Bambi Compressor Oil	1LT	£28.25

Sand Blaster

See Page 1002



Bambi Compressor Tubing



Bambi Compressor Tubing

- Ø6mm tubing for Bambi compressor
- Can be used with the compressor connector C41895
- Will fit all machines with a compressor connection that takes a Ø6mm tube
- Supplied cut to your required length (If you order 2 x 1 metres, you will receive a single 2 metre length piece)

Code	Description	UOM	Price
T54144	Ø6mm Tubing for Compressors	1 Metre	£3.95
Price breaks available, see website			

CUTTERS, BURRS (FRAISES) & FLY



A*F and Bush burrs are made in the EU which embrace exceptional quality and cutting shape edge superiority, expect only the best

- Some of the popular style stone steel burr shapes are used for setting
- We stock a wide variety of sizes and shapes which cater for all your stone settings needs
- See the associated links for an excellent choice of practical stone setting books and equipment. We also recommend if you have not stone set before attend a course
- Various courses are available around the country at various colleges and universities. Remember practice is essential to become a quality stone setter
- Burrs are also popular for use when engraving, texturing and grinding.
- We have put some popular styles of setting/working practices when they use Cousins Material House steel burrs.

Ball Burrs: the most popular steel burrs used in jewellery stone setting, with its all round shape

Bearing Cutter 90° Burrs: the angle of this burr reflects the popular cut diamonds' right angle

Bud tapered burrs: very popular for forming channel setting grooves, particularly on wedding rings.

Concave Cutter Cup Burrs: to round off end points of various sizes of metal, for example on a claw set ring.

Flame burrs: very useful to open out casting flash (a slight film of metal over a whole/crevice).

Knife Edge Cutting Burr: perfectly textures deep grooves on jewellery.

Some basic diamond terms:

- **Facet:** a small surface side of a gemstone.
- **Table:** the large flat top facet. It has an octagonal shape on a round brilliant diamond.
- **Crown:** the upper part of the diamond above the girdle.
- **Girdle:** the narrow rim around the diamond. The girdle plane is parallel to the table and is the largest diameter of any part of the stone.
- **Pavilion:** the lower part of the diamond below the girdle. It has a cone shape on round diamonds.
- **Culet:** the tiny facet on the pointed bottom of the pavilion, parallel to the table.

BURR LUBRICANT

Burr Lubricant Wax

Burr Lubricant Wax

- Extends the life of burrs, saw blades, drills, gravers, taps & dies & diamond tools etc.
- Eliminates burr chatter to give smooth stone seats on settings
- Cleaner and easier to use than oils etc.
- Supplied in handy pad



Code	Description	UOM	Price
O45554	Burr Lubricant Wax	EACH	£2.95

Burr Lubricant Wax, USA

Burr "Cut-Lube" Lubricant Wax

Unique lubricant in a handy stick dispenser for use with burrs, drills, gravers, saw blades etc. to reduce pull and drag. Adds life to your tools by reducing friction and is much easier and cleaner to use than messy oils.



The non-petroleum formula also helps prevent Burr chatter and ensures a smooth, even stone seat on your setting. Also good for diamond tools.

- An amazing space-age lubricant which reduces pull and drag by reducing friction
- Extends the life of burrs, saw blades, drills, gravers, taps & dies & diamond tools etc.
- Eliminates burr chatter to give smooth stone seats on settings
- Cleaner and easier to use than oils etc.
- Supplied in handy stick dispenser
- Made in USA

Code	Description	UOM	Price
B4181	Burr Cut-Lube Lubricant Wax, A*F Swiss	EACH	£4.50
Price breaks available, see website			

ROTARY BURNISHERS (POROSITY REMOVERS)

Rotary Burnisher, A*F Swiss



- A*F Swiss
- Porosity removers for platinum, gold and silver
- These cylindrical burnishers are a remarkably rapid and efficient way of removing porosity, scratches and fire scale from precious metal castings
- Extremely long-lasting, excellent value
- Made from highly polished tungsten carbide, the burnishers have either 12, 18 or 36 facets on the sides to eliminate pores and produce the desired effect
- Mounted on standard shanks 2.35mm (3/32") – Maximum working speed 10,000rpm

Code	Description	UOM	Price
B9579C	Fine (36 facets) Rotary Burnisher	EACH	£65.50
B9579B	Medium (18 facets) Rotary Burnisher	EACH	£65.50
B9579A	Coarse (12 facets) Rotary Burnisher	EACH	£65.50

DIAMOND FLY CUTTERS

Diamond Fly Cutters



These high quality tools are designed to create beautiful designs on jewellery, especially charms, bangles, earrings etc. Made for the professional craftsman to produce bright facets, backgrounds, cuts for setting stones etc., in gold and other precious metals.

The cutting edge is a chip produced from top grade, industrial diamond set in steel. Available in several angles and two shank diameters, popular 3mm & 4mm. Best used in handpieces at speeds between 30,000 & 35,000 rpm.

- American made
- Length 32mm
- Shaft Ø3mm or 4mm



Due to the nature of these tools the manufacturer does not offer a warranty.

Code	Description	UOM	Price
F47553	90 ° Diamond Fly Wheel (3mm Shank)	EACH	£48.95
F47558	90 ° Diamond Fly Wheel (4mm Shank)	EACH	£48.95
F47554	120 ° Diamond Fly Wheel (3mm Shank)	EACH	£48.95
F47559	120 ° Diamond Fly Wheel (4mm Shank)	EACH	£48.95
F47555	130 ° Diamond Fly Wheel (3mm Shank)	EACH	£48.95
F47560	130 ° Diamond Fly Wheel (4mm Shank)	EACH	£48.95
F47556	150 ° Diamond Fly Wheel (3mm Shank)	EACH	£48.95
F47561	150 ° Diamond Fly Wheel (4mm Shank)	EACH	£48.95
F47557	180 ° Diamond Fly Wheel (3mm Shank)	EACH	£48.95
F47562	180 ° Diamond Fly Wheel (4mm Shank)	EACH	£48.95

DIAMOND BURRS

- A*F Swiss diamond impregnated burrs are a world favourite for generations excellent high quality and very durable.
- Cousins diamond impregnated burr sets also available singularly. Exceptional value, durable & long life usage.
- Value diamond burrs give a super and smooth finish on metal, glass and stone. Several shapes and sizes organised in a plastic container.

A wide variety of sets and singular diamond burrs are available. Electroplated diamond particles are the ultimate material for all metal removing/texturing. Add a fine fantastic texturing effect on jewellery. When texturing with these burrs the unique diamond particles will transfer the effect onto the piece leaving the same glittering finish on the jewellery as is on the burr. i.e. The finish looks like glitter has been sprinkled onto the piece. This style is one of the most popular texturing effects in Asian Jewellery before the diamond milling process known as the Shubnum effect.

- Grinds/smoothes away excess metal such as solder
- Used in the glass, engraving and sculpture industry puts a misty / frosty effect on glass
- 140/170 grits
- Shank body size Ø2.35mm or 3/32", which can be used in micromotors and standard quick release hand pieces, (making it easy to change burrs quickly and easily) as well as conventional chuck hand pieces
- Are very popular with jewellers, silversmiths, watch makers/repairers, light engineers, model makers plastic fabricators and in arts and crafts
- Can be used on a whole range of materials such as gold, silver, platinum, copper, brass, pewter, bronze, glass and aluminium
- Finest quality for reliability, long life and satisfaction guaranteed

For glass engraving / texturing & reaming stones and beads, always use water as a lubricant with diamond tools / instruments. No lubrication required for texturing on metal.

A*F Swiss Spherical, Cylindrical and Points Set

Set (01 to 12), A*F Swiss



- Ø2.35mm shank
- Total length 44.5mm
- Set of 12 pieces
- A*F Swiss 119351.01 to 119351.12
- Excellent set for specific accurate work, very good variety
- Multi-use set comes with a wide variety of burrs, including:

Shapes:

- (01) Cone
- (02) Flame Small
- (03) Flame Medium
- (04) Inverted Cylinder Cone
- (05) Tapered Cylinder Large
- (06) Cylinder Medium
- (07) Cylinder Small
- (08) Ball Small
- (09) Ball Medium
- (10) Ball Large
- (11) Ball Extra Large
- (12) Knife Edge Fine

Code	Description	UOM	Price
119351	Set (01 to 12), A*F Swiss	PACK*12	£44.95

(01) Cone



- Cone
- 3.5mm x 6.5mm

Code	Description	UOM	Price
11935101	(01) Cone	EACH	£6.25

(02) Small Flame



- Small Flame
- 0.9mm x 4.5mm

Code	Description	UOM	Price
11935102	(02) Small Flame	EACH	£4.50

(03) Medium Flame



- Medium Flame
- 1.4mm x 10mm

Code	Description	UOM	Price
11935103	(03) Medium Flame	EACH	£4.50

(04) Inverted Cylinder Cone



- Inverted Cylinder Cone
- 1.7mm x 5mm

Code	Description	UOM	Price
11935104	(04) Inverted Cylinder Cone	EACH	£4.50

(05) Large Tapered Cylinder

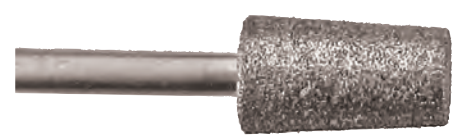

- Large Tapered Cylinder
- 6mm x 10mm

Code	Description	UOM	Price
11935105	(05) Large Tapered Cylinder	EACH	£8.95

(06) Medium Cylinder



- Medium Cylinder
- 2.5mm x 7mm

Code	Description	UOM	Price
11935106	(06) Medium Cylinder	EACH	£4.50

(07) Small Cylinder



- Small Cylinder
- 1.9mm x 7mm

Code	Description	UOM	Price
11935107	(07) Small Cylinder	EACH	£4.50

(08) Small Ball



- Small Ball
- Ø1mm

Code	Description	UOM	Price
11935108	(08) Small Ball	EACH	£4.50

(09) Medium Ball



- Medium Ball
- Ø2mm

Code	Description	UOM	Price
11935109	(09) Medium Ball	EACH	£4.50

(10) Large Ball



- Large Ball

• Ø3mm

Code	Description	UOM	Price
11935110	(10) Large Ball	EACH	£4.50

(11) Extra Large Ball



• Extra Large Ball
• Ø4mm

Code	Description	UOM	Price
11935111	(11) Extra Large Ball	EACH	£5.65

(12) Fine Knife Edge



• Fine Knife Edge
• 2.3mm x 4.0mm

Code	Description	UOM	Price
11935112	(12) Fine Knife Edge	EACH	£4.95

A*F Swiss Tapers, Cones and Inverts Set

Set (01 to 12), A*F Swiss



Tapers, Cones & Inverts

- Ø2.35mm shank
- Total length 44.5mm
- Set of 12 pieces
- A*F Swiss 119350.01 to 119350.12
- Excellent set for precise accurate work, very good variety
- Versatile set comes with a wide selection of burrs

Shapes:

- (01) Cylinder Round Nose
- (02) Cylinder Round Nose Small
- (03) Tapered Fine Point
- (04) Cylinder Extra Large
- (05) Tapered Cylinder Round Nose Extra Large
- (06) Parallel
- (07) Tapered Point Medium
- (08) Tapered Point Small
- (09) Inverted Cone Shallow
- (10) Inverted Cone Shallow Small
- (11) Inverted Cone Medium
- (12) Inverted Cone Small

Code	Description	UOM	Price
119350	Set (01 to 12), A*F Swiss	PACK*12	£54.95

(01) Round Nose Cylinder



• Round Nose Cylinder

• 3mm x 12mm

Code	Description	UOM	Price
11935001	(01) Round Nose Cylinder	EACH	£5.35

(02) Small Round Nose Cylinder



• Small Round Nose Cylinder
• 2mm x 12mm

Code	Description	UOM	Price
11935002	(02) Small Round Nose Cylinder	EACH	£4.50

(03) Fine Tapered Point



• Fine Tapered Point
• 1.5mm x 10mm

Code	Description	UOM	Price
11935003	(03) Fine Tapered Point	EACH	£4.75

(04) Large Cylinder



• Extra Large Cylinder
• 6mm x 11mm

Code	Description	UOM	Price
11935004	(04) Large Cylinder	EACH	£9.10

(05) Round Nose Large Tapered Cylinder



• Round Nose Extra Large Tapered Cylinder
• 7mm x 12mm

Code	Description	UOM	Price
11935005	(05) Round Nose Large Tapered Cylinder	EACH	£12.20

(06) Parallel



• Parallel
• 3mm x 10mm

Code	Description	UOM	Price
11935006	(06) Parallel	EACH	£5.25

(07) Medium Tapered Point



• Medium Tapered Point
• 2mm x 8mm

Code	Description	UOM	Price
11935007	(07) Medium Tapered Point	EACH	£4.50

(08) Small Tapered Point



• Small Tapered Point
• 1.5mm x 4.5mm

Code	Description	UOM	Price
11935008	(08) Small Tapered Point	EACH	£4.95

(09) Shallow Inverted Cone



• Shallow Inverted Cone
• 6mm x 1.6mm

Code	Description	UOM	Price
11935009	(09) Shallow Inverted Cone	EACH	£6.25

(10) Small Shallow Inverted Cone



• Small Shallow Inverted Cone
• 4mm x 0.8mm

Code	Description	UOM	Price
11935010	(10) Small Shallow Inverted Cone	EACH	£4.95

(11) Medium Inverted Cone



• Medium Inverted Cone
• 2.5mm x 2mm

Code	Description	UOM	Price
11935011	(11) Medium Inverted Cone	EACH	£4.50

(12) Small Inverted Cone



• Small Inverted Cone
• 2mm x 1.6mm

Code	Description	UOM	Price
11935012	(12) Small Inverted Cone	EACH	£4.50

Cousins Assorted Shapes Set

Regular Size Diamond Impregnated Burr Set



- Ø2.35mm Shank
- Set of 20 Individually Smaller Burrs
- Diamond Engraving

- Best set for medium work pieces, very good variety
- Multi-purpose set comes with a wide variety of burrs

Shapes:

- 6 x Cylinders
- 2 x Parallel Domed End
- 2 x Points
- 3 x Ball
- 3 x Taper Cylinder
- 1 x Bud
- 1 x Inverted Cone
- 1 x Flame
- 1 x Cone

Weight of set D33871: 50grams

Code	Description	UOM	Price
D33871	Regular Size Diamond Impregnated Burr Set	PACK*20	£9.95

(01) Cylinder



- Cylinder
- Ø1.1mm x 7.5mm

Code	Description	UOM	Price
D33872	(01) Cylinder	EACH	£1.25

(02) Cylinder



- Cylinder
- Ø1.5mm x 7mm

Code	Description	UOM	Price
D33873	(02) Cylinder	EACH	£1.25

(03) Cylinder



- Cylinder
- Ø2.0mm x 7.5mm

Code	Description	UOM	Price
D33874	(03) Cylinder	EACH	£1.25

(04) Cylinder



- Cylinder
- Ø2.4mm x 7mm

Code	Description	UOM	Price
D33875	(04) Cylinder	EACH	£1.25

(05) Cylinder



- Cylinder
- Ø2.7mm x 7mm

Code	Description	UOM	Price
D33876	(05) Cylinder	EACH	£1.25

(06) Cylinder



- Cylinder

- Ø3.2mm x 7mm

Code	Description	UOM	Price
D33877	(06) Cylinder	EACH	£1.25

(07) Parallel Domed End



- Parallel Domed End
- Ø1.4mm x 7mm

Code	Description	UOM	Price
D33878	(07) Parallel Domed End	EACH	£1.25

(08) Parallel Domed End



- Parallel Domed End
- Ø1.9mm x 7mm

Code	Description	UOM	Price
D33879	(08) Parallel Domed End	EACH	£1.25

(09) Point



- Point
- Ø2.0mm x 9.5mm

Code	Description	UOM	Price
D33880	(09) Point	EACH	£1.25

(10) Point



- Point
- Ø2.4mm x 13mm

Code	Description	UOM	Price
D33881	(10) Point	EACH	£1.25

(11) Ball

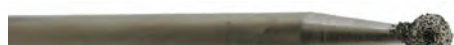

- Ball
- Ø2.0mm

Code	Description	UOM	Price
D33882	(11) Ball	EACH	£1.25

(12) Ball



- Ball
- Ø2.4mm

Code	Description	UOM	Price
D33883	(12) Ball	EACH	£1.25

(13) Ball



- Ball

- Ø3.5mm

Code	Description	UOM	Price
D33884	(13) Ball	EACH	£1.25

(14) Taper Cylinder



- Taper Cylinder
- Ø1.4mm x 7.5mm

Code	Description	UOM	Price
D33885	(14) Taper Cylinder	EACH	£1.25

(15) Taper Cylinder



- Taper Cylinder
- Ø1.9mm x 7mm

Code	Description	UOM	Price
D33886	(15) Taper Cylinder	EACH	£1.25

(16) Taper Cylinder



- Taper Cylinder
- Ø2.7mm x 7mm

Code	Description	UOM	Price
D33887	(16) Taper Cylinder	EACH	£1.25

(17) Bud



- Bud
- Ø4.0mm x 5mm

Code	Description	UOM	Price
D33888	(17) Bud	EACH	£1.25

(18) Inverted Cone



- Inverted Cone
- Ø3.0mm x 7.5mm

Code	Description	UOM	Price
D33889	(18) Inverted Cone	EACH	£1.25

(19) Flame



- Flame
- Ø1.7mm x 10mm

Code	Description	UOM	Price
D33890	(19) Flame	EACH	£1.25

(20) Cone



- Cone

• Ø4.2mm x 6mm

Code	Description	UOM	Price
D33891	(20) Cone	EACH	£1.25

Cousins Assorted Shapes Set, XL

Large Diamond Impregnated Burr Set

COUSINSUK

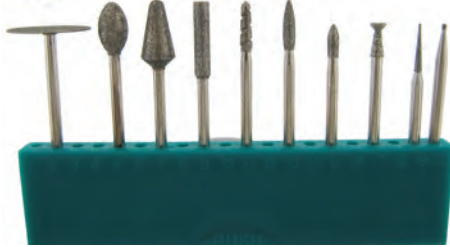

- Set of large Diamond Impregnated Burrs
- Ø2.35mm Shank
- 10 Individually Different Burrs
- Diamond Engraving
- Ideal set for larger work pieces remarkable variety
- Each multi-purpose set comes with a wide variety of burrs
- Includes convenient plastic storage case

Shapes:

- (01) Disc
- (02) Barrel
- (03) Cone Large
- (04) Cylinder Plain
- (05) Parallel Twist
- (06) Flame Large
- (07) Flame Medium
- (08) Inverted Cone Small
- (09) Tapered Point Fine
- (10) Ball Small

Weight of set D33860: 50 grams

Code	Description	UOM	Price
D33860	Large Diamond Impregnated Burr Set	PACK*10	£19.95

(01) Disc



- Disc
- Ø16.0mm x 0.4mm

Code	Description	UOM	Price
D33861	(01) Disc	EACH	£5.75

(02) Barrel



- Barrel

• Ø6mm x 10mm

Code	Description	UOM	Price
D33862	(02) Barrel	EACH	£1.95

(03) Large Cone



- Large Cone
- Large Ø3.0mm to Ø6.0mm x 13.5mm

Code	Description	UOM	Price
D33863	(03) Large Cone	EACH	£1.95

(04) Plain Cylinder



- Plain Cylinder
- Ø3.0mm x 15mm

Code	Description	UOM	Price
D33864	(04) Plain Cylinder	EACH	£1.75

(05) Parallel Twist



- Parallel Twist
- Ø2.5mm x 10mm

Code	Description	UOM	Price
D33865	(05) Parallel Twist	EACH	£1.75

(06) Large Flame



- Large Flame
- Ø2.5mm x 10mm

Code	Description	UOM	Price
D33866	(06) Large Flame	EACH	£1.75

(07) Medium Flame



- Medium Flame
- Ø2.5mm x 6.5mm

Code	Description	UOM	Price
D33867	(07) Medium Flame	EACH	£1.75

(08) Small Inverted Cone



- Small Inverted Cone
- Ø3.0mm x 6.5mm

Code	Description	UOM	Price
D33868	(08) Small Inverted Cone	EACH	£1.75

(09) Fine Tapered Point



- Fine Tapered Point

• Ø1.5mm x 10mm

Code	Description	UOM	Price
D33869	(09) Fine Tapered Point	EACH	£1.75

(10) Small Ball



- Small Ball
- Ø1.0mm

Code	Description	UOM	Price
D33870	(10) Small Ball	EACH	£1.75

Value Assorted Shapes Sets

- Ø2.35mm Shank
- Set of 20 or 30 burrs
- Diamond impregnated
- Best set for medium work pieces, very good variety
- Multi-purpose set comes with a wide variety of burrs
- Includes cylinders, cones, balls and tapers
- Supplied in plastic case

Diamond Burr Set, Pack*20

VALUE



- Pack*20

Code	Description	UOM	Price
D39203	Diamond Burr Set, Pack*20	PACK*20	£3.95

Diamond Burr Set, Pack*30

VALUE



- Pack*30

Code	Description	UOM	Price
D39024	Diamond Burr Set, Pack*30	PACK*30	£4.55

 **Online Discounts**

Micromotor,
Variable Speed,
Marathon



See Page 978

Value Assorted Shapes Sets, Extra Large

Diamond Coated Burrs Set

VALUE



- Ø6.00mm Shank
- Set of 20 burrs
- Diamond impregnated
- Supplied in wooden box

Code	Description	UOM	Price
D53965	Diamond Coated Burrs Set	PACK*10	£19.95

STEEL BURRS, A*F SWISS & BUSCH



A*F Swiss Made and Busch (German) embrace exceptional quality and cutting shape edge superiority, expect only the best.

Finest Quality, in hardened alloy steel for reliability, long life and accuracy. Satisfaction guaranteed. Shaft size is a standard diameter of 2.35mm (3/32").

- Some of the popular style stone steel burr shapes are used for setting
- We stock a wide variety of sizes and shapes which cater for all your stone settings needs
- See the associated links for an excellent choice of practical stone setting books and equipment. We also recommend if you have not stone set before attend a course
- Various courses are available around the country at various colleges and universities. Remember practice is essential to become a quality stone setter
- Burrs are also popular for use when engraving, texturing and grinding.
- We have put some popular styles of setting/

working practices when they use Cousins Material House steel burrs.

Ball Burrs: the most popular steel burrs used in jewellery stone setting, with its all round shape

Bearing Cutter 90° Burrs: the angle of this burr reflects the popular cut diamonds' right angle

Bud tapered burrs: very popular for forming channel setting grooves, particularly on wedding rings.

Concave Cutter Cup Burrs: to round off end points of various sizes of metal, for example on a claw set ring.

Flame burrs: very useful to open out casting flash (a slight film of metal over a whole/ crevice).

Knife Edge Cutting Burr: perfectly textures deep grooves on jewellery.

Ball (A*F 119.300) Most Popular



- A*F 119.300
- Ø2.35mm Shank
- Most popular
- Coarse serrations

Equivalent:
• Busch 1
• Maillefer 23

Ball burrs are the most popular steel burrs used in jewellery stone setting, with its all round shape you can open out stone setting mounts accurately and with speed. Use ball drills on round gemstones, particularly ideal for diamond setting. The gemstone culet and girdle sit well within the bored hole ready for the stone to be secured using gravers/burnishers.

Smaller size ball drills are very useful for claw and channel setting, grooving on the prongs is recommended so the girdle slots and ready to push over. When channel setting, groove the side walls ready for the girdle to sit into the setting.

Code	Description	UOM	Price
119300003	Ø0.30mm Burr, A*F Swiss	EACH	£0.90
119300004	Ø0.40mm Burr, A*F Swiss	EACH	£0.90
119300005	Ø0.50mm Burr, A*F Swiss	EACH	£0.65
119300006	Ø0.60mm Burr, A*F Swiss	EACH	£0.65
119300007	Ø0.70mm Burr, A*F Swiss	EACH	£0.65
119300008	Ø0.80mm Burr, A*F Swiss	EACH	£0.65
119300009	Ø0.90mm Burr, A*F Swiss	EACH	£0.65
119300010	Ø1.00mm Burr, A*F Swiss	EACH	£0.65
119300011	Ø1.10mm Burr, A*F Swiss	EACH	£0.65
119300012	Ø1.20mm Burr, A*F Swiss	EACH	£0.65
119300013	Ø1.30mm Burr, A*F Swiss	EACH	£0.65
119300014	Ø1.40mm Burr, A*F Swiss	EACH	£0.65
119300015	Ø1.50mm Burr, A*F Swiss	EACH	£0.65
119300016	Ø1.60mm Burr, A*F Swiss	EACH	£0.65
119300017	Ø1.70mm Burr, A*F Swiss	EACH	£0.65
119300018	Ø1.80mm Burr, A*F Swiss	EACH	£0.65
119300019	Ø1.90mm Burr, A*F Swiss	EACH	£0.65
119300020	Ø2.00mm Burr, A*F Swiss	EACH	£0.65
119300021	Ø2.10mm Burr, A*F Swiss	EACH	£0.65
119300022	Ø2.20mm Burr, A*F Swiss	EACH	£0.65
119300023	Ø2.30mm Burr, A*F Swiss	EACH	£0.65
119300024	Ø2.40mm Burr, A*F Swiss	EACH	£1.40
119300025	Ø2.50mm Burr, A*F Swiss	EACH	£1.40
119300026	Ø2.60mm Burr, A*F Swiss	EACH	£1.40

119300027	Ø2.70mm Burr, A*F Swiss	EACH	£1.40
119300028	Ø2.80mm Burr, A*F Swiss	EACH	£1.40
119300029	Ø2.90mm Burr, A*F Swiss	EACH	£1.40
119300030	Ø3.00mm Burr, A*F Swiss	EACH	£1.65
119300031	Ø3.10mm Burr, A*F Swiss	EACH	£1.65
119300033	Ø3.30mm Burr, A*F Swiss	EACH	£1.85
119300035	Ø3.50mm Burr, A*F Swiss	EACH	£1.85
119300040	Ø4.00mm Burr, A*F Swiss	EACH	£1.85
119300042	Ø4.20mm Burr, A*F Swiss	EACH	£1.85
119300045	Ø4.50mm Burr, A*F Swiss	EACH	£2.75
119300047	Ø4.70mm Burr, A*F Swiss	EACH	£3.25
119300050	Ø5.00mm Burr, A*F Swiss	EACH	£3.25
119300055	Ø5.50mm Burr, A*F Swiss	EACH	£4.50
119300060	Ø6.00mm Burr, A*F Swiss	EACH	£4.40
119300065	Ø6.50mm Burr, A*F Swiss	EACH	£4.50
119300070	Ø7.00mm Burr, A*F Swiss	EACH	£4.50
119300075	Ø7.50mm Burr, A*F Swiss	EACH	£4.50
119300080	Ø8.00mm Burr, A*F Swiss	EACH	£5.95
119300085	Ø8.50mm Burr, A*F Swiss	EACH	£8.50
119300090	Ø9.00mm Burr, A*F Swiss	EACH	£8.50
119300095	Ø9.50mm Burr, A*F Swiss	EACH	£8.50
119300100	Ø10.00mm Burr, A*F Swiss	EACH	£11.45

Price breaks available, see website

Bearing Cutter 70° Stone Setting (A*F 119.257S)



- A*F Swiss 119.257
- Ø2.35mm Shank
- 70° bearing cutter, Stone Setting
- Popular for stone setting

Equivalent:
• Busch 446
• Maillefer HB

Code	Description	UOM	Price
119257S005	Ø0.50mm Burr, A*F Swiss	EACH	£1.95
119257S006	Ø0.60mm Burr, A*F Swiss	EACH	£1.95
119257S007	Ø0.70mm Burr, A*F Swiss	EACH	£1.95
119257S008	Ø0.80mm Burr, A*F Swiss	EACH	£1.95
119257S009	Ø0.90mm Burr, A*F Swiss	EACH	£1.95
119257S010	Ø1.00mm Burr, A*F Swiss	EACH	£1.95
119257S011	Ø1.10mm Burr, A*F Swiss	EACH	£1.95
119257S012	Ø1.20mm Burr, A*F Swiss	EACH	£1.95
119257S013	Ø1.30mm Burr, A*F Swiss	EACH	£1.95
119257S014	Ø1.40mm Burr, A*F Swiss	EACH	£1.95
119257S015	Ø1.50mm Burr, A*F Swiss	EACH	£1.95
119257S016	Ø1.60mm Burr, A*F Swiss	EACH	£1.95
119257S017	Ø1.70mm Burr, A*F Swiss	EACH	£1.95
119257S018	Ø1.80mm Burr, A*F Swiss	EACH	£1.95
119257S019	Ø1.90mm Burr, A*F Swiss	EACH	£1.95
119257S020	Ø2.00mm Burr, A*F Swiss	EACH	£1.95
119257S021	Ø2.10mm Burr, A*F Swiss	EACH	£1.95
119257S022	Ø2.20mm Burr, A*F Swiss	EACH	£1.95
119257S023	Ø2.30mm Burr, A*F Swiss	EACH	£1.95
119257S025	Ø2.50mm Burr, A*F Swiss	EACH	£2.40
119257S027	Ø2.70mm Burr, A*F Swiss	EACH	£2.40
119257S029	Ø2.90mm Burr, A*F Swiss	EACH	£2.40
119257S031	Ø3.10mm Burr, A*F Swiss	EACH	£2.60
119257S033	Ø3.30mm Burr, A*F Swiss	EACH	£2.60
119257S035	Ø3.50mm Burr, A*F Swiss	EACH	£2.60
119257S037	Ø3.70mm Burr, A*F Swiss	EACH	£2.90

Price breaks available, see website

Bearing Cutter 90 ° Stone Setting (A*F 119.257)



- A*F Swiss 119.257
- Ø2.35mm Shank
- 90 ° bearing cutter, Stone Setting
- Popular for stone setting

The bearing cutter is a popular stone setting burr, also known to stone setters as the stone setting burr. Notice the shape is a round diamond with which makes it unique for the higher quality stone settings as the sits perfectly in the setting.

The 90 ° angle of this burr reflects the popular cut diamonds' right angle. When using this burr the girdle part of the burr will grove excellent results for channel and peg settings. These burrs make setting fast and accurate.

- Equivalent:
- Busch 414
 - Maillefer HD

Code	Description	UOM	Price
119257005	Ø0.50mm Burr, A*F Swiss	EACH	£1.85
119257006	Ø0.60mm Burr, A*F Swiss	EACH	£1.85
119257007	Ø0.70mm Burr, A*F Swiss	EACH	£1.85
119257008	Ø0.80mm Burr, A*F Swiss	EACH	£1.85
119257009	Ø0.90mm Burr, A*F Swiss	EACH	£1.85
119257010	Ø1.00mm Burr, A*F Swiss	EACH	£1.85
119257011	Ø1.10mm Burr, A*F Swiss	EACH	£1.85
119257012	Ø1.20mm Burr, A*F Swiss	EACH	£1.85
119257013	Ø1.30mm Burr, A*F Swiss	EACH	£1.85
119257014	Ø1.40mm Burr, A*F Swiss	EACH	£1.85
119257015	Ø1.50mm Burr, A*F Swiss	EACH	£1.85
119257016	Ø1.60mm Burr, A*F Swiss	EACH	£1.85
119257017	Ø1.70mm Burr, A*F Swiss	EACH	£1.85
119257018	Ø1.80mm Burr, A*F Swiss	EACH	£1.85
119257019	Ø1.90mm Burr, A*F Swiss	EACH	£1.85
119257020	Ø2.00mm Burr, A*F Swiss	EACH	£1.85
119257021	Ø2.10mm Burr, A*F Swiss	EACH	£1.85
119257022	Ø2.20mm Burr, A*F Swiss	EACH	£1.85
119257023	Ø2.30mm Burr, A*F Swiss	EACH	£1.85
119257024	Ø2.40mm Burr, A*F Swiss	EACH	£2.25
119257025	Ø2.50mm Burr, A*F Swiss	EACH	£2.25
119257026	Ø2.60mm Burr, A*F Swiss	EACH	£2.25
119257027	Ø2.70mm Burr, A*F Swiss	EACH	£2.25
119257028	Ø2.80mm Burr, A*F Swiss	EACH	£2.25
119257029	Ø2.90mm Burr, A*F Swiss	EACH	£2.25
119257030	Ø3.00mm Burr, A*F Swiss	EACH	£2.65
119257031	Ø3.10mm Burr, A*F Swiss	EACH	£2.65
119257033	Ø3.30mm Burr, A*F Swiss	EACH	£2.65
119257035	Ø3.50mm Burr, A*F Swiss	EACH	£2.65
119257037	Ø3.70mm Burr, A*F Swiss	EACH	£3.25
119257040	Ø4.00mm Burr, A*F Swiss	EACH	£3.25
119257042	Ø4.20mm Burr, A*F Swiss	EACH	£3.25
119257045	Ø4.50mm Burr, A*F Swiss	EACH	£3.25
119257047	Ø4.70mm Burr, A*F Swiss	EACH	£3.45
119257050	Ø5.00mm Burr, A*F Swiss	EACH	£3.50

Price breaks available, see website

Bearing Cutter 120 ° Stone Setting (A*F 119.272)

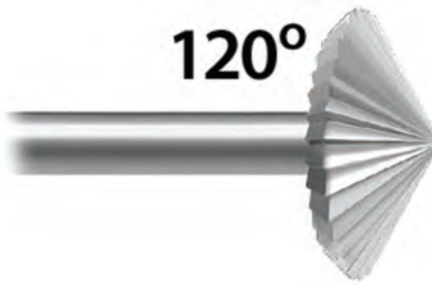

- A*F Swiss 119.272
- Ø2.35mm Shank
- 120 ° bearing cutter, Stone Setting
- Fine serrations

- Equivalent:
- Maillefer H

Code	Description	UOM	Price
119272009	Ø0.90mm Burr, A*F Swiss	EACH	£2.10
119272010	Ø1.00mm Burr, A*F Swiss	EACH	£2.10
119272012	Ø1.20mm Burr, A*F Swiss	EACH	£2.10
119272013	Ø1.30mm Burr, A*F Swiss	EACH	£2.10
119272014	Ø1.40mm Burr, A*F Swiss	EACH	£2.10
119272015	Ø1.50mm Burr, A*F Swiss	EACH	£2.10
119272017	Ø1.70mm Burr, A*F Swiss	EACH	£2.10
119272018	Ø1.80mm Burr, A*F Swiss	EACH	£2.10
119272020	Ø2.00mm Burr, A*F Swiss	EACH	£2.10
119272021	Ø2.10mm Burr, A*F Swiss	EACH	£2.10
119272022	Ø2.20mm Burr, A*F Swiss	EACH	£2.10
119272023	Ø2.30mm Burr, A*F Swiss	EACH	£2.10
119272024	Ø2.40mm Burr, A*F Swiss	EACH	£2.95
119272025	Ø2.50mm Burr, A*F Swiss	EACH	£2.95
119272026	Ø2.60mm Burr, A*F Swiss	EACH	£2.95
119272027	Ø2.70mm Burr, A*F Swiss	EACH	£2.95
119272028	Ø2.80mm Burr, A*F Swiss	EACH	£2.95
119272029	Ø2.90mm Burr, A*F Swiss	EACH	£2.95
119272030	Ø3.00mm Burr, A*F Swiss	EACH	£2.95
119272035	Ø3.50mm Burr, A*F Swiss	EACH	£2.95
119272040	Ø4.00mm Burr, A*F Swiss	EACH	£3.95
119272050	Ø5.00mm Burr, A*F Swiss	EACH	£3.95
119272600	Ø6.00mm Burr, A*F Swiss	EACH	£3.95

Price breaks available, see website

Bud (A*F 119.262) Popular



- A*F Swiss 119.262
- Ø2.35mm shank
- Bud
- Most popular bud shape

- Equivalent:
- Busch 6
 - Maillefer Z

Code	Description	UOM	Price
119262006	Ø0.60mm Burr, A*F Swiss	EACH	£0.88
119262008	Ø0.80mm Burr, A*F Swiss	EACH	£0.88
119262009	Ø0.90mm Burr, A*F Swiss	EACH	£0.88
119262010	Ø1.00mm Burr, A*F Swiss	EACH	£0.88
119262012	Ø1.20mm Burr, A*F Swiss	EACH	£0.88
119262014	Ø1.40mm Burr, A*F Swiss	EACH	£0.88
119262015	Ø1.50mm Burr, A*F Swiss	EACH	£0.88
119262016	Ø1.60mm Burr, A*F Swiss	EACH	£0.88
119262018	Ø1.80mm Burr, A*F Swiss	EACH	£0.88
119262021	Ø2.10mm Burr, A*F Swiss	EACH	£0.88
119262023	Ø2.30mm Burr, A*F Swiss	EACH	£0.88

119262025	Ø2.50mm Burr, A*F Swiss	EACH	£2.05
119262027	Ø2.70mm Burr, A*F Swiss	EACH	£2.05
119262029	Ø2.90mm Burr, A*F Swiss	EACH	£2.05
119262031	Ø3.10mm Burr, A*F Swiss	EACH	£2.05
119262033	Ø3.30mm Burr, A*F Swiss	EACH	£2.05
119262035	Ø3.50mm Burr, A*F Swiss	EACH	£2.05
119262037	Ø3.70mm Burr, A*F Swiss	EACH	£2.05
119262040	Ø4.00mm Burr, A*F Swiss	EACH	£2.60
119262042	Ø4.20mm Burr, A*F Swiss	EACH	£2.65
119262045	Ø4.50mm Burr, A*F Swiss	EACH	£3.05
119262047	Ø4.70mm Burr, A*F Swiss	EACH	£3.05
119262050	Ø5.00mm Burr, A*F Swiss	EACH	£3.05

Price breaks available, see website

Bud (A*F 119.294) Fine Serrations



- A*F Swiss 119.294
- Ø2.35mm shank
- Bud
- Fine serrations

Code	Description	UOM	Price
119294010	Ø1.00mm Burr, A*F Swiss	EACH	£1.35
119294014	Ø1.40mm Burr, A*F Swiss	EACH	£1.35
119294016	Ø1.60mm Burr, A*F Swiss	EACH	£1.35
119294018	Ø1.80mm Burr, A*F Swiss	EACH	£1.35
119294021	Ø2.10mm Burr, A*F Swiss	EACH	£1.35
119294023	Ø2.30mm Burr, A*F Swiss	EACH	£1.35
119294025	Ø2.50mm Burr, A*F Swiss	EACH	£2.52

Price breaks available, see website

Bud (A*F 119.293) Coarse Serrations



- A*F Swiss 119.293
- Ø2.35mm shank
- Bud
- Coarse serrations

- Equivalent:
- Maillefer 83

Code	Description	UOM	Price
119293050	Ø5.00mm Burr, A*F Swiss	EACH	£5.25
119293060	Ø6.00mm Burr, A*F Swiss	EACH	£6.20
119293070	Ø7.00mm Burr, A*F Swiss	EACH	£6.20
119293080	Ø8.00mm Burr, A*F Swiss	EACH	£6.20

Price breaks available, see website

Cone, Inverted (A*F 119.310) Coarse Serrations, Popular



- A*F Swiss 119.310
- Ø2.35mm Shank
- Inverted cone
- Coarse serrations
- Very popular

- Equivalent:
- Busch 2
 - Maillefer 24

Code	Description	UOM	Price
119310006	Ø0.60mm Burr, A*F Swiss	EACH	£0.85
119310007	Ø0.70mm Burr, A*F Swiss	EACH	£0.85

**PRICE PROMISE
GUARANTEE**

119310008	Ø0.80mm Burr, A*F Swiss	EACH	£0.85
119310009	Ø0.90mm Burr, A*F Swiss	EACH	£0.85
119310010	Ø1.00mm Burr, A*F Swiss	EACH	£0.85
119310012	Ø1.20mm Burr, A*F Swiss	EACH	£0.85
119310014	Ø1.40mm Burr, A*F Swiss	EACH	£0.85
119310016	Ø1.60mm Burr, A*F Swiss	EACH	£0.88
119310018	Ø1.80mm Burr, A*F Swiss	EACH	£0.88
119310021	Ø2.10mm Burr, A*F Swiss	EACH	£0.88
119310023	Ø2.30mm Burr, A*F Swiss	EACH	£0.88
119310025	Ø2.50mm Burr, A*F Swiss	EACH	£1.25
119310029	Ø2.90mm Burr, A*F Swiss	EACH	£1.45

Price breaks available, see website

119280050	Ø5.00mm Burr, A*F Swiss	EACH	£3.95
119280055	Ø5.50mm Burr, A*F Swiss	EACH	£4.95
119280600	Ø60.00mm Burr, A*F Swiss	EACH	£4.95

Price breaks available, see website

Cone 90 ° Stone Setting (A*F 119.260)

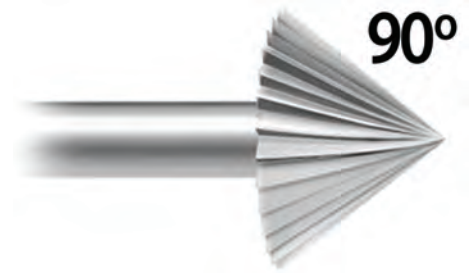

- A*F Swiss 119.260
- Ø2.35mm Shank
- Cone 90 ° Stone Setting

Equivalent:
• Maillefer P

Code	Description	UOM	Price
119260010	Ø1.00mm Burr, A*F Swiss	EACH	£2.20
119260012	Ø1.20mm Burr, A*F Swiss	EACH	£2.20
119260125	Ø1.25mm Burr, A*F Swiss	EACH	£2.20
119260015	Ø1.50mm Burr, A*F Swiss	EACH	£2.20
119260017	Ø1.70mm Burr, A*F Swiss	EACH	£2.20
119260020	Ø2.00mm Burr, A*F Swiss	EACH	£2.20
119260025	Ø2.50mm Burr, A*F Swiss	EACH	£2.75
119260030	Ø3.00mm Burr, A*F Swiss	EACH	£2.75
119260035	Ø3.50mm Burr, A*F Swiss	EACH	£2.75
119260040	Ø4.00mm Burr, A*F Swiss	EACH	£3.90
119260045	Ø4.50mm Burr, A*F Swiss	EACH	£4.05
119260050	Ø5.00mm Burr, A*F Swiss	EACH	£4.05
119260060	Ø6.00mm Burr, A*F Swiss	EACH	£4.60
119260700	Ø7.00mm Burr, A*F Swiss	EACH	£4.60
119260800	Ø8.00mm Burr, A*F Swiss	EACH	£4.60

Price breaks available, see website

Cone 30 ° Stone Setting (A*F 119.253)

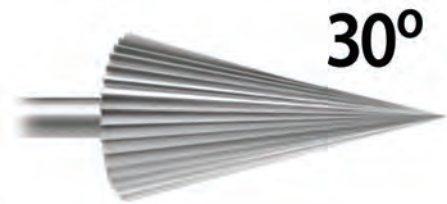

- A*F Swiss 119.253
- Ø2.35mm Shank
- Cone 30 ° Stone Setting
- Fine serrations

Equivalent:
• Maillefer N

Code	Description	UOM	Price
119253010	Ø1.00mm Burr, A*F Swiss	EACH	£2.10
119253015	Ø1.50mm Burr, A*F Swiss	EACH	£2.10
119253020	Ø2.00mm Burr, A*F Swiss	EACH	£2.10
119253025	Ø2.50mm Burr, A*F Swiss	EACH	£2.96
119253030	Ø3.00mm Burr, A*F Swiss	EACH	£2.96
119253035	Ø3.50mm Burr, A*F Swiss	EACH	£2.96
119253040	Ø4.00mm Burr, A*F Swiss	EACH	£4.22
119253050	Ø5.00mm Burr, A*F Swiss	EACH	£4.22
119253060	Ø6.00mm Burr, A*F Swiss	EACH	£4.22
119253070	Ø7.00mm Burr, A*F Swiss	EACH	£5.44
119253080	Ø8.00mm Burr, A*F Swiss	EACH	£5.44
119253090	Ø9.00mm Burr, A*F Swiss	EACH	£8.80

Price breaks available, see website

Cone 45 ° Stone Setting (A*F 119.288) Coarse Serrations, Popular



- A*F Swiss 119.288
- Ø2.35mm Shank
- Cone 45 ° Stone Setting
- Coarse serrations
- Very Popular

Equivalent:
• Busch 5
• Maillefer NN

Code	Description	UOM	Price
119288008	Ø0.80mm Burr, A*F Swiss	EACH	£0.80
119288010	Ø1.00mm Burr, A*F Swiss	EACH	£0.80
119288012	Ø1.20mm Burr, A*F Swiss	EACH	£0.80
119288015	Ø1.50mm Burr, A*F Swiss	EACH	£0.80
119288016	Ø1.60mm Burr, A*F Swiss	EACH	£0.80
119288018	Ø1.80mm Burr, A*F Swiss	EACH	£0.80
119288020	Ø2.00mm Burr, A*F Swiss	EACH	£0.80
119288025	Ø2.50mm Burr, A*F Swiss	EACH	£1.95
119288030	Ø3.00mm Burr, A*F Swiss	EACH	£2.95
119288040	Ø4.00mm Burr, A*F Swiss	EACH	£2.95
119288050	Ø5.00mm Burr, A*F Swiss	EACH	£2.95
119288080	Ø8.00mm Burr, A*F Swiss	EACH	£4.40

Price breaks available, see website

Cone 90 ° Stone Setting (A*F 119.254) with parallel



- A*F Swiss 119.254
- Ø2.35mm Shank
- Cone 90 ° Stone setting
- With Parallel

Equivalent:
• Busch 413
• Maillefer Q

Code	Description	UOM	Price
119254009	Ø0.90mm Burr, A*F Swiss	EACH	£1.85
119254010	Ø1.00mm Burr, A*F Swiss	EACH	£1.85
119254011	Ø1.10mm Burr, A*F Swiss	EACH	£1.85
119254012	Ø1.20mm Burr, A*F Swiss	EACH	£1.85
119254013	Ø1.30mm Burr, A*F Swiss	EACH	£1.85
119254014	Ø1.40mm Burr, A*F Swiss	EACH	£1.85
119254015	Ø1.50mm Burr, A*F Swiss	EACH	£1.95
119254016	Ø1.60mm Burr, A*F Swiss	EACH	£1.95
119254017	Ø1.70mm Burr, A*F Swiss	EACH	£1.95
119254018	Ø1.80mm Burr, A*F Swiss	EACH	£1.95
119254019	Ø1.90mm Burr, A*F Swiss	EACH	£1.95
119254020	Ø2.00mm Burr, A*F Swiss	EACH	£1.95
119254021	Ø2.10mm Burr, A*F Swiss	EACH	£1.95
119254022	Ø2.20mm Burr, A*F Swiss	EACH	£1.95
119254023	Ø2.30mm Burr, A*F Swiss	EACH	£1.95

Cone 45 ° Stone Setting (A*F 119.280) Medium Serrations

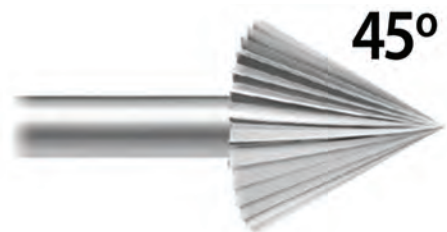

- A*F Swiss 119.280
- Ø2.35mm Shank
- Cone 45 ° Stone Setting
- Medium serrations

Equivalent:
• Maillefer NN

Code	Description	UOM	Price
119280010	Ø1.00mm Burr, A*F Swiss	EACH	£2.10
119280015	Ø1.50mm Burr, A*F Swiss	EACH	£2.10
119280020	Ø2.00mm Burr, A*F Swiss	EACH	£2.10
119280025	Ø2.50mm Burr, A*F Swiss	EACH	£3.20
119280030	Ø3.00mm Burr, A*F Swiss	EACH	£3.20
119280035	Ø3.50mm Burr, A*F Swiss	EACH	£3.20
119280040	Ø4.00mm Burr, A*F Swiss	EACH	£3.50
119280045	Ø4.50mm Burr, A*F Swiss	EACH	£3.50

Cone 60 ° Stone Setting (A*F 119.282)

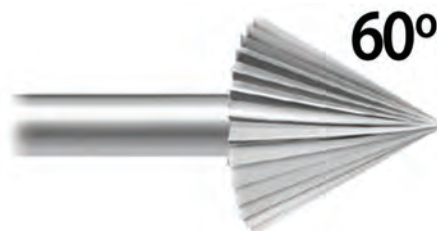

- A*F Swiss 119.282
- Ø2.35mm Shank
- Cone 60 ° Stone Setting

Equivalent:
• Maillefer O

Code	Description	UOM	Price
119282010	Ø1.00mm Burr, A*F Swiss	EACH	£1.95
119282015	Ø1.50mm Burr, A*F Swiss	EACH	£1.95
119282020	Ø2.00mm Burr, A*F Swiss	EACH	£2.05
119282030	Ø3.00mm Burr, A*F Swiss	EACH	£2.35
119282350	Ø3.50mm Burr, A*F Swiss	EACH	£3.85
119282040	Ø4.00mm Burr, A*F Swiss	EACH	£3.85
119282060	Ø6.00mm Burr, A*F Swiss	EACH	£3.95
119282700	Ø7.00mm Burr, A*F Swiss	EACH	£4.50

Price breaks available, see website



119254024	Ø2.40mm Burr, A*F Swiss	EACH	£2.55
119254025	Ø2.50mm Burr, A*F Swiss	EACH	£2.60
119254027	Ø2.70mm Burr, A*F Swiss	EACH	£2.60
119254029	Ø2.90mm Burr, A*F Swiss	EACH	£2.60
119254030	Ø3.00mm Burr, A*F Swiss	EACH	£2.75
119254031	Ø3.10mm Burr, A*F Swiss	EACH	£2.75
119254033	Ø3.30mm Burr, A*F Swiss	EACH	£2.75
119254035	Ø3.50mm Burr, A*F Swiss	EACH	£2.75
119254037	Ø3.70mm Burr, A*F Swiss	EACH	£3.85
119254040	Ø4.00mm Burr, A*F Swiss	EACH	£3.85
119254042	Ø4.20mm Burr, A*F Swiss	EACH	£3.85
119254045	Ø4.50mm Burr, A*F Swiss	EACH	£3.85
119254047	Ø4.70mm Burr, A*F Swiss	EACH	£3.85
119254050	Ø5.00mm Burr, A*F Swiss	EACH	£3.95
119254060	Ø6.00mm Burr, A*F Swiss	EACH	£4.30
119254650	Ø6.50mm Burr, A*F Swiss	EACH	£4.30
119254070	Ø7.00mm Burr, A*F Swiss	EACH	£4.50
119254080	Ø8.00mm Burr, A*F Swiss	EACH	£4.90

Price breaks available, see website

Cup, Concave Cutter (A*F 119.256)

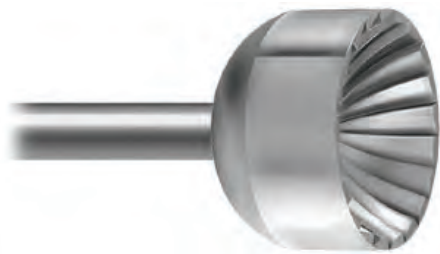

- A*F Swiss 119.256
- Ø2.35mm Shank
- Cup drills
- Concave cutter cup
- Medium serrations

Cup burrs are used to round off end points of various sizes of metal, for example on a claw set ring the end of the claw holding the stone is domed, this has been rounded off with this type of burr.

This classic claw cluster finisher ensures jewellery will not catch items of clothing when worn. A good example of this is if a customer wears a peg cluster and it has not been finished with a cup burr, when they take off their coat/cardigan it could catch and possibly tear their clothing.

- Equivalent:
- Busch 411
 - Maillefer S

Code	Description	UOM	Price
119256008	Ø0.80mm Burr, A*F Swiss	EACH	£1.85
119256009	Ø0.90mm Burr, A*F Swiss	EACH	£1.85
119256010	Ø1.00mm Burr, A*F Swiss	EACH	£1.85
119256011	Ø1.10mm Burr, A*F Swiss	EACH	£1.85
119256012	Ø1.20mm Burr, A*F Swiss	EACH	£1.85
119256013	Ø1.30mm Burr, A*F Swiss	EACH	£1.85
119256014	Ø1.40mm Burr, A*F Swiss	EACH	£1.85
119256015	Ø1.50mm Burr, A*F Swiss	EACH	£1.85
119256016	Ø1.60mm Burr, A*F Swiss	EACH	£1.85
119256165	Ø1.65mm Burr, A*F Swiss	EACH	£1.85
119256017	Ø1.70mm Burr, A*F Swiss	EACH	£1.85
119256018	Ø1.80mm Burr, A*F Swiss	EACH	£1.85
119256019	Ø1.90mm Burr, A*F Swiss	EACH	£1.85
119256020	Ø2.00mm Burr, A*F Swiss	EACH	£1.85
119256021	Ø2.10mm Burr, A*F Swiss	EACH	£1.85
119256022	Ø2.20mm Burr, A*F Swiss	EACH	£1.85
119256023	Ø2.30mm Burr, A*F Swiss	EACH	£1.85
119256025	Ø2.50mm Burr, A*F Swiss	EACH	£2.50
119256027	Ø2.70mm Burr, A*F Swiss	EACH	£2.50
119256029	Ø2.90mm Burr, A*F Swiss	EACH	£2.50
119256030	Ø3.00mm Burr, A*F Swiss	EACH	£2.50
119256035	Ø3.50mm Burr, A*F Swiss	EACH	£3.10
119256040	Ø4.00mm Burr, A*F Swiss	EACH	£3.95
119256045	Ø4.50mm Burr, A*F Swiss	EACH	£3.95

119256050	Ø5.00mm Burr, A*F Swiss	EACH	£3.95
119256055	Ø5.50mm Burr, A*F Swiss	EACH	£4.50
119256060	Ø6.00mm Burr, A*F Swiss	EACH	£4.50
119256065	Ø6.50mm Burr, A*F Swiss	EACH	£4.75
119256070	Ø7.00mm Burr, A*F Swiss	EACH	£4.75
119256075	Ø7.50mm Burr, A*F Swiss	EACH	£4.75
119256080	Ø8.00mm Burr, A*F Swiss	EACH	£4.75
119256085	Ø8.50mm Burr, A*F Swiss	EACH	£8.15
119256090	Ø9.00mm Burr, A*F Swiss	EACH	£8.15
119256095	Ø9.50mm Burr, A*F Swiss	EACH	£8.15
119256100	Ø10.00mm Burr, A*F Swiss	EACH	£12.25

Price breaks available, see website

Cup, Concave Cutter (A*F 119.256SC) Super Cut



- A*F Swiss 119.256SC
- Super Cut
- also known as "S Cut"
- Ø2.35mm Shank
- Cup drills
- Concave cutter cup
- Coarse serrations

Cup burrs are used to round off end points of various sizes of metal, for example on a claw set ring the end of the claw holding the stone is domed, this has been rounded off with this type of burr.

This classic claw cluster finisher ensures jewellery will not catch items of clothing when worn. A good example of this is if a customer wears a peg cluster and it has not been finished with a cup burr, when they take off their coat/cardigan it could catch and possibly tear their clothing.

- Equivalent:
- Maillefer S Cut

Code	Description	UOM	Price
119256SC008	Ø0.80mm Burr, A*F Swiss	EACH	£1.85
119256SC009	Ø0.90mm Burr, A*F Swiss	EACH	£1.85
119256SC010	Ø1.00mm Burr, A*F Swiss	EACH	£1.85
119256SC011	Ø1.10mm Burr, A*F Swiss	EACH	£1.85
119256SC012	Ø1.20mm Burr, A*F Swiss	EACH	£1.85
119256SC013	Ø1.30mm Burr, A*F Swiss	EACH	£1.85
119256SC014	Ø1.40mm Burr, A*F Swiss	EACH	£1.85
119256SC015	Ø1.50mm Burr, A*F Swiss	EACH	£1.85
119256SC016	Ø1.60mm Burr, A*F Swiss	EACH	£1.85
119256SC017	Ø1.70mm Burr, A*F Swiss	EACH	£1.85
119256SC018	Ø1.80mm Burr, A*F Swiss	EACH	£1.85
119256SC019	Ø1.90mm Burr, A*F Swiss	EACH	£1.85
119256SC020	Ø2.00mm Burr, A*F Swiss	EACH	£1.85
119256SC021	Ø2.10mm Burr, A*F Swiss	EACH	£1.95
119256SC022	Ø2.20mm Burr, A*F Swiss	EACH	£1.95
119256SC023	Ø2.30mm Burr, A*F Swiss	EACH	£1.95

Price breaks available, see website

Cylinder Cross Cut, parallel (A*F 119.315)



- A*F Swiss 119.315
- Ø2.35mm Shank
- Cylinder cross cut
- Coarse serrations

Equivalent:

- Maillefer 34

Code	Description	UOM	Price
119315006	Ø0.60mm Burr, A*F Swiss	EACH	£0.95
119315007	Ø0.70mm Burr, A*F Swiss	EACH	£0.95
119315008	Ø0.80mm Burr, A*F Swiss	EACH	£0.95
119315009	Ø0.90mm Burr, A*F Swiss	EACH	£0.95
119315010	Ø1.00mm Burr, A*F Swiss	EACH	£0.95
119315012	Ø1.20mm Burr, A*F Swiss	EACH	£0.95
119315014	Ø1.40mm Burr, A*F Swiss	EACH	£0.95
119315016	Ø1.60mm Burr, A*F Swiss	EACH	£0.95
119315018	Ø1.80mm Burr, A*F Swiss	EACH	£0.95
119315021	Ø2.10mm Burr, A*F Swiss	EACH	£0.95
119315023	Ø2.30mm Burr, A*F Swiss	EACH	£0.95
119315025	Ø2.50mm Burr, A*F Swiss	EACH	£1.95
119315027	Ø2.70mm Burr, A*F Swiss	EACH	£1.95

Price breaks available, see website

Cylinder Cross Cut, tapered (A*F 119.320)



- A*F Swiss 119.320
- Ø2.35mm Shank
- Cylinder tapered cross cut
- Coarse serrations

Open out holes left over from casting flashing and are popular for engraving name plates.

Equivalent:

- Maillefer 38

Code	Description	UOM	Price
119320006	Ø0.60mm Burr, A*F Swiss	EACH	£0.90
119320007	Ø0.70mm Burr, A*F Swiss	EACH	£0.90
119320008	Ø0.80mm Burr, A*F Swiss	EACH	£0.90
119320009	Ø0.90mm Burr, A*F Swiss	EACH	£0.90
119320010	Ø1.00mm Burr, A*F Swiss	EACH	£0.90
119320011	Ø1.10mm Burr, A*F Swiss	EACH	£0.90
119320012	Ø1.20mm Burr, A*F Swiss	EACH	£0.90
119320013	Ø1.30mm Burr, A*F Swiss	EACH	£0.90
119320014	Ø1.40mm Burr, A*F Swiss	EACH	£0.90
119320015	Ø1.50mm Burr, A*F Swiss	EACH	£0.90
119320016	Ø1.60mm Burr, A*F Swiss	EACH	£0.90
119320018	Ø1.80mm Burr, A*F Swiss	EACH	£0.90
119320021	Ø2.10mm Burr, A*F Swiss	EACH	£0.90
119320023	Ø2.30mm Burr, A*F Swiss	EACH	£0.90
119320025	Ø2.50mm Burr, A*F Swiss	EACH	£1.85

Price breaks available, see website

Cylinder Parallel (A*F 119.255) Fine Serrations



- A*F Swiss 119.255
- Ø2.35mm Shank
- Cylinder
- Fine serrations

Equivalent:

- Maillefer R

Code	Description	UOM	Price
119255010	Ø1.00mm Burr, A*F Swiss	EACH	£2.10
119255015	Ø1.50mm Burr, A*F Swiss	EACH	£2.10

119255020	Ø2.00mm Burr, A*F Swiss	EACH	£2.10
119255025	Ø2.50mm Burr, A*F Swiss	EACH	£2.75
119255030	Ø3.00mm Burr, A*F Swiss	EACH	£2.75
119255035	Ø3.50mm Burr, A*F Swiss	EACH	£2.75
119255040	Ø4.00mm Burr, A*F Swiss	EACH	£3.95
119255045	Ø4.50mm Burr, A*F Swiss	EACH	£3.95
119255050	Ø5.00mm Burr, A*F Swiss	EACH	£4.00
119255060	Ø6.00mm Burr, A*F Swiss	EACH	£4.90
119255070	Ø7.00mm Burr, A*F Swiss	EACH	£4.95
119255080	Ø8.00mm Burr, A*F Swiss	EACH	£4.95
119255090	Ø9.00mm Burr, A*F Swiss	EACH	£8.30
119255100	Ø10.00mm Burr, A*F Swiss	EACH	£12.50
Price breaks available, see website			

Cylinder Parallel (A*F 119.325) Coarse Serrations



- A*F Swiss 119.325
- Ø2.35mm Shank
- Cylinder parallel
- Coarse serrations

Equivalent:
• Busch 21
• Maillefer 16

Code	Description	UOM	Price
119325007	Ø0.70mm Burr, A*F Swiss	EACH	£0.78
119325008	Ø0.80mm Burr, A*F Swiss	EACH	£0.78
119325009	Ø0.90mm Burr, A*F Swiss	EACH	£0.78
119325010	Ø1.00mm Burr, A*F Swiss	EACH	£0.78
119325012	Ø1.20mm Burr, A*F Swiss	EACH	£0.78
119325014	Ø1.40mm Burr, A*F Swiss	EACH	£0.78
119325016	Ø1.60mm Burr, A*F Swiss	EACH	£0.78
119325018	Ø1.80mm Burr, A*F Swiss	EACH	£0.78
119325021	Ø2.10mm Burr, A*F Swiss	EACH	£0.78
119325023	Ø2.30mm Burr, A*F Swiss	EACH	£0.78
119325025	Ø2.50mm Burr, A*F Swiss	EACH	£1.55
119325027	Ø2.70mm Burr, A*F Swiss	EACH	£1.65
Price breaks available, see website			

Cylinder Parallel (A*F 119.329) Twisted



- A*F Swiss 119.329
- Ø2.35mm Shank
- Cylinder parallel
- Twister serrations

Equivalent:
• Maillefer 29

Code	Description	UOM	Price
119329007	Ø0.70mm Burr, A*F Swiss	EACH	£0.90
119329008	Ø0.80mm Burr, A*F Swiss	EACH	£0.90
119329009	Ø0.90mm Burr, A*F Swiss	EACH	£0.90
119329010	Ø1.00mm Burr, A*F Swiss	EACH	£0.90
119329012	Ø1.20mm Burr, A*F Swiss	EACH	£0.90
119329014	Ø1.40mm Burr, A*F Swiss	EACH	£0.90
119329016	Ø1.60mm Burr, A*F Swiss	EACH	£0.90
119329018	Ø1.80mm Burr, A*F Swiss	EACH	£0.90
119329021	Ø2.10mm Burr, A*F Swiss	EACH	£0.90
119329023	Ø2.30mm Burr, A*F Swiss	EACH	£0.90
119329025	Ø2.50mm Burr, A*F Swiss	EACH	£1.65
119329027	Ø2.70mm Burr, A*F Swiss	EACH	£1.65
Price breaks available, see website			

Cylinder Rounded (A*F 119.285) Coarse Serrations



- A*F Swiss 119.285
- Ø2.35mm Shank
- Cylinder
- Coarse serrations

Equivalent:
• Busch 72
• Maillefer 78

Code	Description	UOM	Price
119285050	Ø5.00mm Burr, A*F Swiss	EACH	£4.15
119285060	Ø6.00mm Burr, A*F Swiss	EACH	£4.15
119285070	Ø7.00mm Burr, A*F Swiss	EACH	£4.95
119285080	Ø8.00mm Burr, A*F Swiss	EACH	£6.50
Price breaks available, see website			

Cylinder Tapered (A*F 119.330) Coarse Serrations



- A*F Swiss 119.330
- Ø2.35mm Shank
- Cylinder tapered
- Coarse serrations

Equivalent:
• Maillefer 30

Code	Description	UOM	Price
119330009	Ø0.90mm Burr, A*F Swiss	EACH	£0.90
119330010	Ø1.00mm Burr, A*F Swiss	EACH	£0.90
119330012	Ø1.20mm Burr, A*F Swiss	EACH	£0.90
119330014	Ø1.40mm Burr, A*F Swiss	EACH	£0.90
119330016	Ø1.60mm Burr, A*F Swiss	EACH	£0.90
119330018	Ø1.80mm Burr, A*F Swiss	EACH	£0.90
119330021	Ø2.10mm Burr, A*F Swiss	EACH	£0.90
119330023	Ø2.30mm Burr, A*F Swiss	EACH	£0.90
119330025	Ø2.50mm Burr, A*F Swiss	EACH	£1.77
Price breaks available, see website			

Egg (A*F 119.292)



- A*F Swiss 119.292
- Ø2.35mm Shank
- Egg
- Coarse serrations

Equivalent:
• Maillefer 79

Code	Description	UOM	Price
119292050	Ø5.00mm Burr, A*F Swiss	EACH	£4.85
119292060	Ø6.00mm Burr, A*F Swiss	EACH	£5.70
119292070	Ø7.00mm Burr, A*F Swiss	EACH	£5.70
119292080	Ø8.00mm Burr, A*F Swiss	EACH	£6.65
Price breaks available, see website			

Flame (A*F 119.286)



- A*F Swiss 119.286
- Ø2.35mm Shank
- Flame
- Coarse serrations

Flame or Bud tapered burrs are very popular burrs for forming channel setting grooves, particularly on wedding rings. The smaller sizes are ideal to open out holes if you have castings with blocked holes.

Equivalent:
• Busch 4
• Maillefer 81

Code	Description	UOM	Price
119286450	Ø4.50mm Burr, A*F Swiss	EACH	£3.95
119286050	Ø5.00mm Burr, A*F Swiss	EACH	£3.95
119286060	Ø6.00mm Burr, A*F Swiss	EACH	£3.95
Price breaks available, see website			

Flame (Busch 4)



- Busch 4
- 2.35mm Shank
- Flame

Flame burrs are very useful to open out casting flash (a slight film of metal over a whole/crevice) as they are finely pointed and get into awkward areas.

Equivalent:
• A*F 119.286
• Maillefer 81

Code	Description	UOM	Price
B008009	Ø0.90mm Burr, Bucsh	EACH	£0.85
B008010	Ø1.00mm Burr, Bucsh	EACH	£0.85
B008012	Ø1.20mm Burr, Bucsh	EACH	£0.85
B008014	Ø1.40mm Burr, Bucsh	EACH	£0.85
B008016	Ø1.60mm Burr, Bucsh	EACH	£0.85
B008018	Ø1.80mm Burr, Bucsh	EACH	£0.85
B008021	Ø2.10mm Burr, Bucsh	EACH	£0.85
Price breaks available, see website			

Flame Cross Cut, Krause (A*F 119.289)



- A*F Swiss 119.289
- Ø2.35mm Shank
- Fine flame point
- Cross serrations

Ideal for forming and shaping openings, used for fine detail and cleaning small hard to access places.

Equivalent:
• Busch 194
• Maillefer FK

Code	Description	UOM	Price
119289010	Ø1.00mm Burr, A*F Swiss	EACH	£1.95
119289012	Ø1.20mm Burr, A*F Swiss	EACH	£1.95
Price breaks available, see website			

Knife Edge (or Lens) Cutter (A*F 119.251)



- A*F Swiss 119.251
- Ø2.35mm Shank
- Knife edge (or Lens) cutter
- Medium serrations

This Knife Edge Cutting Burr perfectly textures deep grooves on jewellery; this effect looks like the bark of a tree and gives a proud contrast on your piece which will not wear off.

- Equivalent:
- Busch 234
 - Maillefer HH

Code	Description	UOM	Price
119251009	Ø0.90mm Burr, A*F Swiss	EACH	£1.95
119251010	Ø1.00mm Burr, A*F Swiss	EACH	£1.95
119251011	Ø1.10mm Burr, A*F Swiss	EACH	£1.95
119251012	Ø1.20mm Burr, A*F Swiss	EACH	£1.95
119251013	Ø1.30mm Burr, A*F Swiss	EACH	£1.95
119251014	Ø1.40mm Burr, A*F Swiss	EACH	£1.95
119251015	Ø1.50mm Burr, A*F Swiss	EACH	£2.10
119251016	Ø1.60mm Burr, A*F Swiss	EACH	£2.10
119251017	Ø1.70mm Burr, A*F Swiss	EACH	£2.10
119251018	Ø1.80mm Burr, A*F Swiss	EACH	£2.10
119251019	Ø1.90mm Burr, A*F Swiss	EACH	£2.10
119251020	Ø2.00mm Burr, A*F Swiss	EACH	£2.10
119251021	Ø2.10mm Burr, A*F Swiss	EACH	£2.10
119251022	Ø2.20mm Burr, A*F Swiss	EACH	£2.10
119251023	Ø2.30mm Burr, A*F Swiss	EACH	£2.10
119251024	Ø2.40mm Burr, A*F Swiss	EACH	£3.10
119251025	Ø2.50mm Burr, A*F Swiss	EACH	£3.10
119251027	Ø2.70mm Burr, A*F Swiss	EACH	£3.10
119251029	Ø2.90mm Burr, A*F Swiss	EACH	£3.10
119251030	Ø3.00mm Burr, A*F Swiss	EACH	£3.10
119251031	Ø3.10mm Burr, A*F Swiss	EACH	£3.10
119251033	Ø3.30mm Burr, A*F Swiss	EACH	£3.10
119251035	Ø3.50mm Burr, A*F Swiss	EACH	£3.10
119251037	Ø3.70mm Burr, A*F Swiss	EACH	£4.25
119251040	Ø4.00mm Burr, A*F Swiss	EACH	£4.25
119251042	Ø4.20mm Burr, A*F Swiss	EACH	£4.25
119251045	Ø4.50mm Burr, A*F Swiss	EACH	£4.25
119251047	Ø4.70mm Burr, A*F Swiss	EACH	£4.25
119251050	Ø5.00mm Burr, A*F Swiss	EACH	£4.50
119251060	Ø6.00mm Burr, A*F Swiss	EACH	£5.75
119251070	Ø7.00mm Burr, A*F Swiss	EACH	£5.75
119251080	Ø8.00mm Burr, A*F Swiss	EACH	£5.75
119251090	Ø9.00mm Burr, A*F Swiss	EACH	£7.85
119251100	Ø10.00mm Burr, A*F Swiss	EACH	£11.75

Price breaks available, see website

Oval (A*F 119.278) Medium Serrations



- A*F Swiss 119.278
- Ø2.35mm Shank
- Oval
- Medium serrations

- Equivalent:
- Maillefer Y

Code	Description	UOM	Price
119278010	Ø1.00mm Burr, A*F Swiss	EACH	£2.25
1192780125	Ø1.25mm Burr, A*F Swiss	EACH	£2.25
119278015	Ø1.50mm Burr, A*F Swiss	EACH	£2.25
119278020	Ø2.00mm Burr, A*F Swiss	EACH	£2.60
119278030	Ø3.00mm Burr, A*F Swiss	EACH	£2.95
119278040	Ø4.00mm Burr, A*F Swiss	EACH	£3.95
119278050	Ø5.00mm Burr, A*F Swiss	EACH	£3.95
119278060	Ø6.00mm Burr, A*F Swiss	EACH	£5.70
119278070	Ø7.00mm Burr, A*F Swiss	EACH	£5.70
119278080	Ø8.00mm Burr, A*F Swiss	EACH	£5.70
119278100	Ø10.00mm Burr, A*F Swiss	EACH	£9.95

Price breaks available, see website

Oval (A*F 119.284) Coarse Serrations



- A*F Swiss 119.284
- Ø2.35mm Shank
- Oval
- Coarse serrations

- Equivalent:
- Maillefer 23

Code	Description	UOM	Price
119284050	Ø5.00mm Burr, A*F Swiss	EACH	£4.81
119284060	Ø6.00mm Burr, A*F Swiss	EACH	£4.81
119284070	Ø7.00mm Burr, A*F Swiss	EACH	£6.72
119284080	Ø8.00mm Burr, A*F Swiss	EACH	£6.72

Price breaks available, see website

Pear (A*F 119.290)

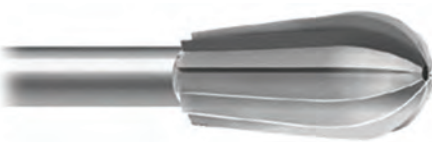

- A*F Swiss 119.290
- Ø2.35mm Shank
- Pear
- Coarse serrations

- Equivalent:
- Busch 77
 - Maillefer 80

Code	Description	UOM	Price
119290050	Ø5.00mm Burr, A*F Swiss	EACH	£4.35
119290060	Ø6.00mm Burr, A*F Swiss	EACH	£4.35
119290070	Ø7.00mm Burr, A*F Swiss	EACH	£4.89

119290080	Ø8.00mm Burr, A*F Swiss	EACH	£4.89
-----------	-------------------------	------	-------

Price breaks available, see website

Pear or Long Bud (A*F 119.291)



- A*F Swiss 119.291
- Ø2.35mm Shank
- Pear or long bud
- Coarse serrations

- Equivalent:
- Busch 79
 - Maillefer 82

Code	Description	UOM	Price
119291050	Ø5.00mm Burr, A*F Swiss	EACH	£4.85
119291060	Ø6.00mm Burr, A*F Swiss	EACH	£5.50
119291070	Ø7.00mm Burr, A*F Swiss	EACH	£6.20
119291080	Ø8.00mm Burr, A*F Swiss	EACH	£6.85

Price breaks available, see website

Round, Fine (A*F 119.250)



- A*F Swiss 119.250
- Ø2.35mm Shank
- Round
- Fine serrations

- Equivalent:
- Busch 41
 - Maillefer A

Code	Description	UOM	Price
119250010	Ø1.00mm Burr, A*F Swiss	EACH	£2.10
119250125	Ø1.25mm Burr, A*F Swiss	EACH	£2.10
119250015	Ø1.50mm Burr, A*F Swiss	EACH	£2.10
119250020	Ø2.00mm Burr, A*F Swiss	EACH	£2.10
119250025	Ø2.50mm Burr, A*F Swiss	EACH	£2.96
119250030	Ø3.00mm Burr, A*F Swiss	EACH	£2.96
119250035	Ø3.50mm Burr, A*F Swiss	EACH	£2.96
119250040	Ø4.00mm Burr, A*F Swiss	EACH	£3.95
119250045	Ø4.50mm Burr, A*F Swiss	EACH	£3.95
119250050	Ø5.00mm Burr, A*F Swiss	EACH	£3.95
119250060	Ø6.00mm Burr, A*F Swiss	EACH	£4.90
119250070	Ø7.00mm Burr, A*F Swiss	EACH	£4.90
119250080	Ø8.00mm Burr, A*F Swiss	EACH	£4.90
119250090	Ø9.00mm Burr, A*F Swiss	EACH	£6.95
119250100	Ø10.00mm Burr, A*F Swiss	EACH	£11.95

Price breaks available, see website

Bradbury's Hallmarking Guide



See Page 1526

Foredom Brushless Micromotor



See Page 975

Round, coarse (A*F 119.283)



- A*F Swiss 119.283
- Ø2.35mm Shank
- Round
- Coarse serrations

Code	Description	UOM	Price
119283060	Ø6.00mm Burr, A*F Swiss	EACH	£3.39
119283070	Ø7.00mm Burr, A*F Swiss	EACH	£3.39
119283080	Ø8.00mm Burr, A*F Swiss	EACH	£3.91
Price breaks available, see website			

Round, pearl peg (A*F 119.263)



- A*F Swiss 119.263
- Ø2.35mm Shank
- Round with hole
- Fine serrations

This highly specialized ball shape burr has a central hole for producing a stem to fix pearls, plus also to clean the area around the existing peg without damaging it. The profile is the same as a round burr, but with a hole in the centre to create or accommodate the pearl peg.

Code	Description	UOM	Price
119263020	Ø2.00mm Burr, A*F Swiss	EACH	£5.50
119263040	Ø4.00mm Burr, A*F Swiss	EACH	£5.64
119263050	Ø5.00mm Burr, A*F Swiss	EACH	£6.15
Price breaks available, see website			

Wheel (A*F 119.261) Fine Serrations



- A*F Swiss 119.261
- Ø2.35mm Shank
- Wheel
- Fine serrations

Equivalent:
• Maillefer RR

Code	Description	UOM	Price
119261010	Ø1.00mm Burr, A*F Swiss	EACH	£2.20
119261015	Ø1.50mm Burr, A*F Swiss	EACH	£2.20
119261020	Ø2.00mm Burr, A*F Swiss	EACH	£2.20
119261025	Ø2.50mm Burr, A*F Swiss	EACH	£3.10
119261030	Ø3.00mm Burr, A*F Swiss	EACH	£3.10
119261035	Ø3.50mm Burr, A*F Swiss	EACH	£3.10
119261040	Ø4.00mm Burr, A*F Swiss	EACH	£4.10
119261050	Ø5.00mm Burr, A*F Swiss	EACH	£4.10

119261060	Ø6.00mm Burr, A*F Swiss	EACH	£4.75
119261900	Ø90mm Burr, A*F Swiss	EACH	£7.95
Price breaks available, see website			

Wheel (A*F 119.276) Medium Serrations

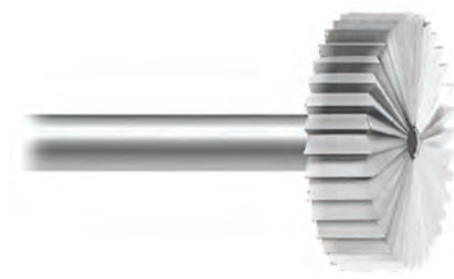

- A*F Swiss 119.276
- Ø2.35mm Shank
- Wheel
- Medium serrations

Equivalent:

- Busch 409L
- Maillefer KK

Code	Description	UOM	Price
119276010	Ø1.00mm Burr, A*F Swiss	EACH	£2.05
119276015	Ø1.50mm Burr, A*F Swiss	EACH	£2.05
119276020	Ø2.00mm Burr, A*F Swiss	EACH	£2.05
119276025	Ø2.50mm Burr, A*F Swiss	EACH	£2.65
119276030	Ø3.00mm Burr, A*F Swiss	EACH	£2.65
119276040	Ø4.00mm Burr, A*F Swiss	EACH	£3.95
119276050	Ø5.00mm Burr, A*F Swiss	EACH	£3.95
119276060	Ø6.00mm Burr, A*F Swiss	EACH	£4.85
119276080	Ø8.00mm Burr, A*F Swiss	EACH	£4.85
119276090	Ø9.00mm Burr, A*F Swiss	EACH	£9.10
119276100	Ø10.00mm Burr, A*F Swiss	EACH	£9.10
Price breaks available, see website			

Wheel (A*F 119.305) Coarse Serrations



- A*F Swiss 119.305
- Ø2.35mm Shank
- Wheel
- Coarse serrations

The best burr for channel setting as it can be run in-between the channel, causing a fine groove for setting the diamond girdle.

Equivalent:

- Busch 3
- Maillefer 25

Code	Description	UOM	Price
119305006	Ø0.60mm Burr, A*F Swiss	EACH	£0.65
119305007	Ø0.70mm Burr, A*F Swiss	EACH	£0.65
119305008	Ø0.80mm Burr, A*F Swiss	EACH	£0.65
119305009	Ø0.90mm Burr, A*F Swiss	EACH	£0.65
119305010	Ø1.00mm Burr, A*F Swiss	EACH	£0.65
119305012	Ø1.20mm Burr, A*F Swiss	EACH	£0.65
119305014	Ø1.40mm Burr, A*F Swiss	EACH	£0.65
119305016	Ø1.60mm Burr, A*F Swiss	EACH	£0.65
119305018	Ø1.80mm Burr, A*F Swiss	EACH	£0.65
119305021	Ø2.10mm Burr, A*F Swiss	EACH	£0.65
119305023	Ø2.30mm Burr, A*F Swiss	EACH	£0.65
119305025	Ø2.50mm Burr, A*F Swiss	EACH	£1.25
119305027	Ø2.70mm Burr, A*F Swiss	EACH	£1.25

119305029	Ø2.90mm Burr, A*F Swiss	EACH	£1.25
Price breaks available, see website			

Wheel, Cutting Saw (A*F 119.274) Medium Serrations

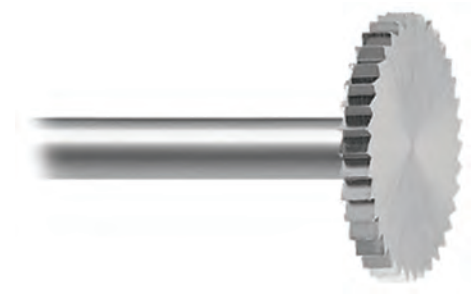

- A*F Swiss 119.274
- Ø2.35mm shank
- Wheel, cutting saw
- Mounted saw
- Blank Top
- Medium serrations

Equivalent:

- Maillefer k

Code	Description	UOM	Price
119274010	Ø1.00mm Burr, A*F Swiss	EACH	£1.95
119274015	Ø1.50mm Burr, A*F Swiss	EACH	£1.95
119274020	Ø2.00mm Burr, A*F Swiss	EACH	£1.95
119274025	Ø2.50mm Burr, A*F Swiss	EACH	£2.75
119274030	Ø3.00mm Burr, A*F Swiss	EACH	£2.75
119274035	Ø3.50mm Burr, A*F Swiss	EACH	£2.75
119274040	Ø4.00mm Burr, A*F Swiss	EACH	£2.95
119274050	Ø5.00mm Burr, A*F Swiss	EACH	£3.25
119274060	Ø6.00mm Burr, A*F Swiss	EACH	£4.85
119274070	Ø7.00mm Burr, A*F Swiss	EACH	£4.85
119274080	Ø8.00mm Burr, A*F Swiss	EACH	£4.85
119274090	Ø9.00mm Burr, A*F Swiss	EACH	£7.95
119274100	Ø10.00mm Burr, A*F Swiss	EACH	£11.75
Price breaks available, see website			

Wheel, Cutting Saw (A*F 119.306) Coarse Serrations



- A*F Swiss 119.306
- Ø2.35mm Shank
- Wheel, cutting saw
- Mounted saw
- Blank Top
- Coarse serrations

Equivalent:

- Maillefer 45

Code	Description	UOM	Price
119306023	Ø2.30mm Burr, A*F Swiss	EACH	£2.30
119306029	Ø2.90mm Burr, A*F Swiss	EACH	£2.50
119306035	Ø3.50mm Burr, A*F Swiss	EACH	£3.15
119306040	Ø4.00mm Burr, A*F Swiss	EACH	£3.25
Price breaks available, see website			

Burr Lubricating Wax



See Page 702

**STEEL BURRS,
COUSINS EURO**

COUSINSUK Euro



CousinsUK Burrs

In first quality carbon steel ensuring reliability, long life and accuracy. Satisfaction guaranteed. Shaft size is a standard diameter of 2.35mm (3/32").

- Excellent value
- This range has an excellent cutting pattern for standard cost repair/manufacturing work
- Made from 1st grade quality carbon steel ensuring you long usage
- Available in various shapes and sizes.
- Favourite for the stone setter, engraver, model maker etc.

Ball (Cousins) Most Popular



- Ø2.35mm Shank
- Most popular
- Coarse serrations

Equivalent:
• Busch 1
• Maillefer 23

Ball burrs are the most popular steel burrs used in jewellery stone setting, with its all round shape you can open out stone setting mounts accurately and with speed. Use ball drills on round gemstones, particularly ideal for diamond setting. The gemstone culet and girdle sit well within the bored hole ready for the stone to be secured using gravers/burnishers.

Smaller size ball drills are very useful for claw and channel setting, grooving on the prongs is recommended so the girdle slots and ready to push over. When channel setting, groove the side walls ready for the girdle to sit into the setting.

Code	Description	UOM	Price
B35762	Ø0.50mm Ball Burr	PACK*6	£2.85
B35763	Ø0.60mm Ball Burr	PACK*6	£2.85
B35764	Ø0.70mm Ball Burr	PACK*6	£2.85
B35765	Ø0.80mm Ball Burr	PACK*6	£2.85
B35766	Ø0.90mm Ball Burr	PACK*6	£2.85
B35767	Ø1.00mm Ball Burr	PACK*6	£2.85
B35768	Ø1.10mm Ball Burr	PACK*6	£2.85
B35769	Ø1.20mm Ball Burr	PACK*6	£2.85
B35770	Ø1.30mm Ball Burr	PACK*6	£2.85
B35771	Ø1.40mm Ball Burr	PACK*6	£2.85
B35772	Ø1.50mm Ball Burr	PACK*6	£2.85
B35773	Ø1.60mm Ball Burr	PACK*6	£2.85
B35774	Ø1.70mm Ball Burr	PACK*6	£2.85
B35775	Ø1.80mm Ball Burr	PACK*6	£2.85
B35776	Ø1.90mm Ball Burr	PACK*6	£2.85
B35777	Ø2.00mm Ball Burr	PACK*6	£2.85
B35778	Ø2.10mm Ball Burr	PACK*6	£2.85

B35779	Ø2.20mm Ball Burr	PACK*6	£2.85
B35780	Ø2.30mm Ball Burr	PACK*6	£2.85

Bearing Cutter 90 ° Stone Setting (Cousins)



- Ø2.35mm Shank
- 90 ° bearing cutter
- Popular for stone setting

The bearing cutter is a popular stone setting burr, also known to stone setters as the stone setting burr. Notice the shape is a round diamond with which makes it unique for the higher quality stone settings as the sits perfectly in the setting.

The 90 ° angle of this burr reflects the popular cut diamonds' right angle. When using this burr the girdle part of the burr will groove excellent results for channel and peg settings. These burrs make setting fast and accurate.

Equivalent:
• Busch 414
• Maillefer HD

Code	Description	UOM	Price
B35796	Ø0.90mm Stone Setting Burr	PACK*6	£7.75
B35797	Ø1.00mm Stone Setting Burr	PACK*6	£7.75
B35798	Ø1.10mm Stone Setting Burr	PACK*6	£7.75
B35799	Ø1.20mm Stone Setting Burr	PACK*6	£7.75
B35800	Ø1.30mm Stone Setting Burr	PACK*6	£7.75
B35801	Ø1.40mm Stone Setting Burr	PACK*6	£7.75
B35802	Ø1.50mm Stone Setting Burr	PACK*6	£7.75
B35803	Ø1.60mm Stone Setting Burr	PACK*6	£7.75
B35804	Ø1.70mm Stone Setting Burr	PACK*6	£7.75
B35805	Ø1.80mm Stone Setting Burr	PACK*6	£7.75
B35806	Ø1.90mm Stone Setting Burr	PACK*6	£7.75
B35807	Ø2.00mm Stone Setting Burr	PACK*6	£7.75
B35808	Ø2.10mm Stone Setting Burr	PACK*6	£7.75
B35895	Ø2.20mm Stone Setting Burr	PACK*6	£7.75
B35809	Ø2.30mm Stone Setting Burr	PACK*6	£7.75

Cup, concave cutter (Cousins)

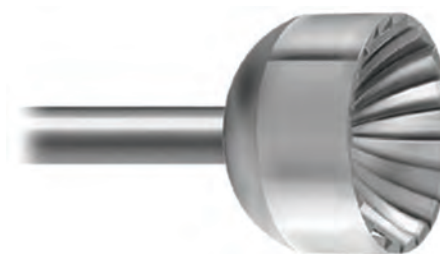

- Ø2.35mm Shank
- Cup drills
- Concave cutter cup

Cup burrs are used to round off end points of various sizes of metal, for example on a claw set ring the end of the claw holding the stone is domed, this has been rounded off with this type of burr. This classic claw cluster finisher ensures jewellery will not catch items of clothing when worn. A good example of this is if a customer is wearing a peg cluster ring which has not been rounded off by a cup burr, it may snag and tear on items of clothing or even catch on doors etc.

Equivalent:

- Busch 411
- Maillefer S

Code	Description	UOM	Price
B35781	Ø0.90mm Cup Burr	PACK*6	£6.95
B35782	Ø1.00mm Cup Burr	PACK*6	£6.95
B35783	Ø1.10mm Cup Burr	PACK*6	£6.95
B35784	Ø1.20mm Cup Burr	PACK*6	£6.95
B35785	Ø1.30mm Cup Burr	PACK*6	£6.95
B35786	Ø1.40mm Cup Burr	PACK*6	£6.95
B35787	Ø1.50mm Cup Burr	PACK*6	£6.95
B35788	Ø1.60mm Cup Burr	PACK*6	£6.95
B35789	Ø1.70mm Cup Burr	PACK*6	£6.95
B35790	Ø1.80mm Cup Burr	PACK*6	£6.95
B35791	Ø1.90mm Cup Burr	PACK*6	£6.95
B35792	Ø2.00mm Cup Burr	PACK*6	£6.95
B35793	Ø2.10mm Cup Burr	PACK*6	£6.95
B35794	Ø2.20mm Cup Burr	PACK*6	£6.95
B35795	Ø2.30mm Cup Burr	PACK*6	£6.95

Cylinder Cross Cut, tapered (Cousins)



- 2.35mm Shank
- Cylinder tapered cross cut
- Coarse serrations

Open out holes left over from casting flashing and are popular for engraving name plates.

Equivalent:
• Maillefer 38

Code	Description	UOM	Price
B35810	Ø0.60mm Cone Cross Cut	PACK*6	£6.15
B35811	Ø0.70mm Cone Cross Cut	PACK*6	£6.15
B35812	Ø0.80mm Cone Cross Cut	PACK*6	£6.15
B35813	Ø0.90mm Cone Cross Cut	PACK*6	£6.15
B35814	Ø1.00mm Cone Cross Cut	PACK*6	£6.15
B35815	Ø1.10mm Cone Cross Cut	PACK*6	£6.15
B35816	Ø1.20mm Cone Cross Cut	PACK*6	£6.15
B35817	Ø1.40mm Cone Cross Cut	PACK*6	£6.15
B35818	Ø1.50mm Cone Cross Cut	PACK*6	£6.15
B35819	Ø1.60mm Cone Cross Cut	PACK*6	£6.15
B35820	Ø1.80mm Cone Cross Cut	PACK*6	£6.15
B35821	Ø2.00mm Cone Cross Cut	PACK*6	£6.15
B35822	Ø2.10mm Cone Cross Cut	PACK*6	£6.15
B35823	Ø2.30mm Cone Cross Cut	PACK*6	£6.15

Flame (Cousins)



- Ø2.35mm Shank
- Tapered Flame Burr

Flame or Bud tapered burrs are very popular burrs for forming channel setting grooves, particularly on wedding rings. The smaller sizes are ideal to open out holes if you have castings with blocked holes.

Equivalent:
• Busch 4
• Maillefer 81

Code	Description	UOM	Price
B35837	Ø0.90mm Bud Burr	PACK*6	£3.25
B35838	Ø1.00mm Bud Burr	PACK*6	£3.25
B35840	Ø1.20mm Bud Burr	PACK*6	£3.25
B35841	Ø1.40mm Bud Burr	PACK*6	£3.25
B35842	Ø1.50mm Bud Burr	PACK*6	£3.25

B35843	Ø1.60mm Bud Burr	PACK*6	£3.25
B35844	Ø1.70mm Bud Burr	PACK*6	£3.25
B35845	Ø1.80mm Bud Burr	PACK*6	£3.25
B35846	Ø1.90mm Bud Burr	PACK*6	£3.25
B35847	Ø2.00mm Bud Burr	PACK*6	£3.25
B35848	Ø2.10mm Bud Burr	PACK*6	£3.25
B35849	Ø2.30mm Bud Burr	PACK*6	£3.25

Wheel (Cousins) Coarse Serrations



- 2.35mm Shank
- Wheel
- Coarse serrations

The best burr for channel setting as it can be run in-between the channel, causing a fine groove for setting the diamond girdle.

- Equivalent:
- Busch 3
 - Maillefer 25

Code	Description	UOM	Price
B35824	Ø0.60mm Wheel Burr	PACK*6	£3.25
B35825	Ø0.70mm Wheel Burr	PACK*6	£3.25
B35826	Ø0.80mm Wheel Burr	PACK*6	£3.25
B35827	Ø0.90mm Wheel Burr	PACK*6	£3.25
B35828	Ø1.00mm Wheel Burr	PACK*6	£3.25
B35829	Ø1.10mm Wheel Burr	PACK*6	£3.25
B35830	Ø1.20mm Wheel Burr	PACK*6	£3.25
B35831	Ø1.30mm Wheel Burr	PACK*6	£3.25
B35832	Ø1.40mm Wheel Burr	PACK*6	£3.25
B35835	Ø2.20mm Wheel Burr	PACK*6	£3.25
B35836	Ø2.30mm Wheel Burr	PACK*6	£3.25

STEEL BURRS, SETS

Popular Shapes, Larger Sizes Ø1.5mm to Ø6mm



A*F Swiss

Set of 24 fine cut "Swiss Made" burrs, containing 9 of the most popular shapes in diameters Ø1.50mm to Ø6.00mm. All shaft diameters Ø2.35mm. Mounted on a plastic stand for easy selected and storage with a plastic transparent cover.

- Set Contains;
- 119.250: (1.5 - 3.0 - 4.5 - 6.0mm) (Maillefer A)
 - 119.274: (3.0 - 6.0mm) (Maillefer K)
 - 119.253: (3.0 - 4.5 - 5.0mm) (Maillefer N)
 - 119.282: (2.0 - 3.0 - 4.0mm) (Maillefer O)
 - 119.260: (3.0 - 5.0mm) (Maillefer P)
 - 119.254: (3.0 - 4.5 - 6.0mm) (Maillefer Q)
 - 119.261: (3.0 - 5.0 - 6.0mm) (Maillefer RR)
 - 119.256: (2.0 - 3.0 - 4.5 - 6.0mm) (Maillefer S)

Code	Description	UOM	Price
B47261	Popular Shapes, Larger Sizes Ø1.5mm to Ø6mm	PACK*24	£94.95

Popular Shapes, Smaller Sizes Ø1mm to Ø2mm



A*F Swiss

Set of 24 fine cut "Swiss Made" burrs, containing 12 of the most popular shapes in diameters Ø1.00mm to Ø2.00mm. All shaft diameters Ø2.35mm. Mounted on a plastic stand for easy selected and storage with a plastic transparent cover.

- Set Contains;
- 119.250: (1.0 - 1.5 - 2.0mm) (Maillefer A)
 - 119.251: (1.0 - 2.0mm) (Maillefer HH)
 - 119.274: (2.0mm) (Maillefer K)
 - 119.252: (1.0 - 2.1mm) (Maillefer 24)
 - 119.280: (2.0mm) (Maillefer NN)
 - 119.253: (2.0mm) (Maillefer N)
 - 119.260: (1.0 - 1.5 - 2.0mm) (Maillefer P)
 - 119.254: (1.0 - 1.5 - 2.0mm) (Maillefer Q)
 - 119.261: (2.0mm) (Maillefer RR)
 - 119.256: (1.0 - 1.2 - 1.5 - 2.0mm) (Maillefer S)
 - 119.278: (2.0mm) (Maillefer Y)
 - 119.262: (1.0 - 2.1mm) (Maillefer Z(r))

Code	Description	UOM	Price
B47262	Popular Shapes, Smaller Sizes Ø1mm to Ø2mm	PACK*24	£44.75

PRICE PROMISE GUARANTEE



WORLDWIDE DELIVERY



ORDER tracking



Online Discounts

CUTTERS, COUNTER-SINKS & PIVOT

Countersinks, A*F Swiss



A*F Swiss

Individually or a set of six double-ended wheel-type countersinks (roller sinks) in steel with knurled grip. For creating the semi circular half sphere shaped oil sinks in newly inserted clock bushes etc.

6 Sizes:

- Ø1.80 / 2.10mm
- Ø2.50 / 2.80mm
- Ø3.00 / 3.30mm
- Ø3.50 / 3.80mm
- Ø4.00 / 4.30mm
- Ø4.50 / 5.00mm

Code	Description	UOM	Price
C47536	Ø2.50 & Ø2.80mm Countersink	EACH	£12.25
C47539	Ø4.00 & Ø4.30mm Countersink	EACH	£12.25
C47540	Ø4.50 & Ø5.00mm Countersink	EACH	£12.25

Countersinks, Bergeon



Bergeon 1897

Individually or a set of six double-ended wheel-type countersinks (roller sinks) in steel with knurled grip. For creating the semi circular half sphere shaped oil sinks in newly inserted clock bushes etc.

Set of 6 Sizes:

- Ø1.80 / 2.10mm
- Ø2.50 / 2.80mm
- Ø3.00 / 3.30mm
- Ø3.50 / 3.80mm
- Ø4.00 / 4.30mm
- Ø4.50 / 5.00mm

Code	Description	UOM	Price
C0394	Countersinks - Bergeon 1897	PACK*6	£64.50

Countersinks, Horotec



Horotec

Individually or a set of six double-ended wheel-type countersinks (roller sinks) in polished hardened steel with knurled grip. For creating the semi circular half sphere shaped oil sinks in newly inserted clock bushes etc.

- 6 Sizes:
- Ø1.75 / 1.85mm
 - Ø2.10 / 2.35mm
 - Ø2.75 / 3.00mm
 - Ø3.40 / 3.80mm
 - Ø4.10 / 4.70mm
 - Ø5.00 / 5.80mm

Code	Description	UOM	Price
C54146	Countersinks Set	PACK*6	£59.95
C54152	Ø1.75 & 1.85mm Countersink	EACH	£12.25
C54151	Ø2.10 & 2.35mm Countersink	EACH	£12.25
C54150	Ø2.75 & 3.00mm Countersink	EACH	£12.25
C54149	Ø3.40 & 3.80mm Countersink	EACH	£12.25
C54148	Ø4.10 & 4.70mm Countersink	EACH	£12.25
C54147	Ø5.00 & 5.80mm Countersink	EACH	£12.25

End Mills (Pivot & Screw Cutters), Bergeon 30414



- Double ended cutters
- Perfect for enlarging holes, cleaning screw heads, clearing dial feet and bevelling
- Pack*6
- Supplied in wooden case
- Bergeon 30414

Set contains:

- Double-ended conical cutter Ø3.00mm & Ø4.50mm
- Double-ended bevelling cutters Ø3.00mm & Ø4.00mm
- Double-ended bevelling cutter Ø1.00mm & Ø2.00mm
- Double-ended cutter to trim screw ends Ø2.50mm & Ø4.00mm
- Double-ended cutter to trim screw ends Ø0.90mm & Ø1.30mm
- Double-ended burr remover, 4 cutting edges with hollow centre. Ø3.00mm x Ø0.65 mm & Ø4.00 x Ø0.90mm (external diameter x hole diameter)

Code	Description	UOM	Price
C48923	Double Ended Pivot Cutters	PACK*6	£179.95

End Mills (Pivot & Screw Cutters), Bergeon 30007-MD



Assortment of 12 end-mill pivot and screw cutters in hard metal with pivots.

The pivots work as a guide in the hole and the end mills trim the desired part. The pivots are interchangeable with every end mill. It can be used by hand or on a press.

- Bergeon 30007-MD
- Supplied in a Wooden Case
- 12 cutters
- 12 Pivots
- Fixing Sleeves
- Broach
- Hard metal alloy, 90% tungsten with titanium & cobalt

Cutters:

- Ø1.30, 1.60, 1.90, 2.20, 2.50, 2.80mm
- Ø3.10, 3.40, 3.70, 4.00, 4.30, 4.50mm

Pivots:

- Ø0.60mm x 4
- Ø0.70, 0.80, 0.90, 1.00mm
- Ø1.10, 1.20, 1.30, 1.50mm

Code	Description	UOM	Price
C20881	End Mills (Pivot & Screw Cutters) Set, Bergeon 30007.MD	EACH	£1,095.00
C22325	End Mill Ø1.30mm	EACH	£114.95
C22326	End Mill Ø1.60mm	EACH	£114.95
C31430	End Mill Ø1.90mm	EACH	£137.50
C31431	End Mill Ø2.20mm	EACH	£116.50
C31432	End Mill Ø2.50mm	EACH	£116.50
C31433	End Mill Ø2.80mm	EACH	£116.50
C31434	End Mill Ø3.10mm	EACH	£116.50
C31435	End Mill Ø3.40mm	EACH	£116.50
C31436	End Mill Ø3.70mm	EACH	£116.50
C31437	End Mill Ø4.00mm	EACH	£116.50
C31438	End Mill Ø4.30mm	EACH	£116.50
C31439	End Mill Ø4.50mm	EACH	£116.50
C40939	Pivot Ø0.40mm	EACH	£55.95
C40940	Pivot Ø0.45mm	EACH	£55.95
C40941	Pivot Ø0.50mm	EACH	£55.95
C40942	Pivot Ø0.60mm	EACH	£49.95
C40943	Pivot Ø0.70mm	EACH	£49.95
C40944	Pivot Ø0.80mm	EACH	£49.95
C40945	Pivot Ø0.90mm	EACH	£49.95
C40946	Pivot Ø1.00mm	EACH	£49.95
C40947	Pivot Ø1.10mm	EACH	£49.95
C40948	Pivot Ø1.20mm	EACH	£49.95
C40949	Pivot Ø1.30mm	EACH	£49.95
C40950	Pivot Ø1.50mm	EACH	£49.95

HSS Twist Drills, UK Made

See Page 749

End Mills (Pivot & Screw Cutters), Horotec 22.577



- Assortment of 12 hard metal end mills
- Perfect for enlarging holes, cleaning screw heads, clearing dial feet, removing burrs and bevelling
- Stainless steel shank with synthetic hexagonal head mounted on a ball bearing
- 12 interchangeable end mills all fit to the handle
- Supplied in plastic case with foam protective insert
- Horotec 22.577

Set contains:

- Knurled stainless steel handle
- Conical end mill Ø3.00mm
- Conical end mill Ø4.50mm
- Bevelling cutter Ø1.00mm
- Bevelling cutter Ø2.00mm
- Bevelling cutter Ø3.00mm
- Bevelling cutter Ø4.00mm
- Cutter to trim screw ends Ø0.90mm
- Cutter to trim screw ends Ø1.30mm
- Cutter to trim screw ends Ø2.50mm
- Cutter to trim screw ends Ø4.00mm
- Burr remover Ø3.00mm
- Burr remover Ø4.00mm

Code	Description	UOM	Price
B49773	End Mills & Pivot Cutters, Horotec 22.577	EACH	£159.50

CUTTERS, RING (WEDDING & GEM)



Even though cutting a ring off is not a jewellery repair, sometimes it falls to a retailer, gold buyer, goldsmith to cut away a ring that can no longer be taken off a finger. This most often happens because an injury or illness has caused the hand to swell, but it might be a matter of simply "growing attached" to your jewellery.

The solution is to use a ring cutter made for this purpose. In our range we have various types of Ring Cutters, in principle they all do

the same process but differ in their usage and budget. Remember we supply spare blades which is handy to have because as in time they can wear out. Depending on the metal being cut and thickness a blade can wear quicker if it is cutting a platinum ring rather than a 22ct one.

A general guide on how to use...

Ring cutter pliers work on a leverage and circular saw rotating system. On the top side a circular saw is fitted on a key which rotates forwards and backwards by turning by hand and revolving. The opposite side notice a "V" machined end with a fine centre groove.

Place the customers hand flat on a table and push the "V" groove under the ring (in between the skin and the inside of the ring) this will protect the finger while cutting. Close your ring cutter applying slight pressure on the blade connecting with the outside of the ring shank and rotate clockwise. The circular saw will start to cut the ring from the outside of the shank.

Applying some bees wax on the blade before and while cutting will prolong blade life and give a smoother cut. Try not to go so fast and press too hard just let the blade teeth smoothly do the work.

As the ring is now cut through use two pairs of bent nose/snipe nose pliers to pull ring apart removing it from the finger.

A*F Swiss Ring Cutter

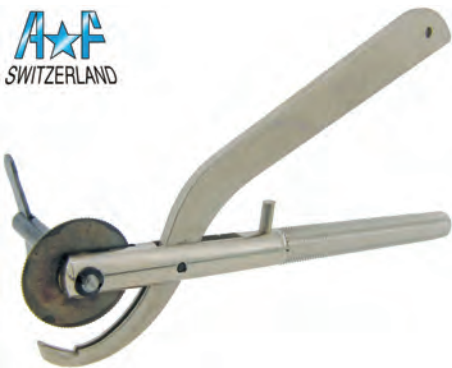

- A*F Swiss 18114 - In nickel steel, well finished. Hardened steel sawblade
- One of the worlds favourite standard ring cutters
 - Gold silver platinum cutting recommended
 - Supplied with ring cutter opening key and blade
 - Blade size Ø20mm
 - Made in Steel
 - Size: length 120mm
 - Weight: 85grams
 - Supplied with blade (R4867)

Code	Description	UOM	Price
R4866	A*F Swiss Ring Cutting Tool	EACH	£31.95
R4867	A*F Swiss Ring Cutter Spare Blade	EACH	£11.45
R19998	A*F Swiss Ring Cutter Key	EACH	£3.50
R19999	A*F Swiss Ring Cutter Black Locking Nut	EACH	£3.20
R20000	A*F Swiss Ring Cutter Handle	EACH	£4.95

Bergeon Ring Cutter



- Bergeon Swiss 30410.99
 Considered to be the worlds best ring cutter
- Excellent for a busy retail shop, handling busy work loads with confidence
 - Light weight made in aluminium
 - Strong and improved
 - Supplied with blade (R15254) HSS
 - Gold, silver & platinum cutting recommended
 - Spring loaded with adjustable depth adjusting fixing screw
 - Size: length 160mm
 - Weight: 190grams

Code	Description	UOM	Price
R15253	Bergeon (30410.PAR) Ring Cutting Tool	EACH	£199.95
R15254	Bergeon (30410-99) Ring Cutting Tool Blade	EACH	£33.50
R6514	Bergeon (30410-99) Ring Cutting Tool Key	EACH	£16.50

Cousins Swiss Style Ring Cutter



- Cousins Swiss Style
- Large model in polished forged steel. Sturdy construction.
- Blade size Ø30mm x hole 3.5mm
 - Length 165mm
 - Weight: 165g
 - Replacement blade P47134 (supplied separately)

Code	Description	UOM	Price
P47133	Cousins Ring Cutter (Large)	EACH	£17.95
P47134	Cousins Ring Cutter (Large) Blade	EACH	£9.95

Value Ring Cutter



Thumb pressure ring cutter

- Light weight easy to handle steel construction
- Blade size Ø20mm
- Gold/silver ring cutting recommended
- Fantastic value, made in India
- Overall Length 160mm
- Weight: 85grams
- Replacement Blade: R31947 (supplied separately)

Code	Description	UOM	Price
R31946	Value Emergency Ring Cutting Tool	EACH	£7.95
R31947	Value Emergency Ring Cutting Tool Spare Blade	EACH	£5.50

CUTTING



CousinsUK have a huge selection of hand cutting tools in stock for every workshop and any task. We stock numerous different types and from all over the world, from your hobbyist pair to your top end professional, we have it catered for. The types of cutters we have available offer unsurpassed cutting capacity covering a wide range of wire dimensions and types.

Cousins range of scalpels & scissors, useful for all types of work. Essential for jobbing with uses varying from cutting wax models for creating air holes during the Delft casting process, mould casting and general cutting, etching, scribing, retouching stencil layouts and paste tips.

Cutter styles and wire ends:

Bevelled:

- Leaving a standard rise of metal on your wire is acceptable and indeed required in some particular jewellery/component casting or manufacturing
- Bevel cutters require more cutting force and are therefore very durable
- They leave a large pinch on wire ends

Semi flush, bevelled cutter

- Slight bevel edge to cut thicker wire and leads
- A fine nip would be left in the middle after the item has been cut
- Semi flush cutters require less force and leave a small pinch

Super flush cutter



- A precise thin bevel which leaves a unique small nip in the middle of the item being cut
- Super flush cutters require minimal cutting force and leave almost no pinch

Full flush cutter

- No nip cutters, perform like two razor blades coming together
- Full flush cutters require the least amount of force and leave no pinch on wire ends

Accu-Shear Adjustable Stop Cutters

COUSINSUK



Create a true flush cut with the Accu-Shear cutters with a material stop with screw feed and set screw regulates the length of the wire.

- Adjustable Stop
- Also has a standard side cutter
- Gives a true shear cut, no waste with your material
- Leaves end truly flush
- No need for filing
- Cut wire up to 6 gauge (4mm)
- Supplied with stop to allow multiple lengths of wire to be cut accurately
- Maximum length of wire cut with stop is 60mm
- With flat nose jaws
- PVC coated handles
- Overall length: 200mm
- Cousins Swiss style
- Superb Swiss style quality

Code	Description	UOM	Price
P48611	Accu-Shear Cutters	EACH	£19.95

Diagonal or Side Cutters

Super Flush Cut: Our large range sourced from all over the world, able to tackle all major workshop metal cutting and precision work.

- For cutting wire or small pieces of sheet metal
- The most commonly used cutter
- The tapered ends allow the cutter to get into tight areas
- Cutters are industry standard and are not suitable for cutting stainless steel
- Value cutters are only suitable for cutting material like solder, rubber, leather etc.

Please be advised that cutters are not guaranteed against breakage or damage

A*F Swiss (115mm)

A*F SWITZERLAND



A*F Swiss
Superior quality cutters in polished steel with box joint. Blue plastic handles with double leaf springs.

- Side Cutters
- Length 115mm

Code	Description	UOM	Price
C47349	A*F Swiss (115mm)	EACH	£17.95

A*F Swiss (115mm) Smart Grip

A*F SWITZERLAND



A*F Swiss
Superb quality cutters with comfortable "Smart Grip" blue and black handles.

- Side Cutters
- Length 115mm

Code	Description	UOM	Price
C47339	A*F Swiss (115mm) Smart Grip	EACH	£22.85

A*F Swiss (130mm)

A*F SWITZERLAND



A*F Swiss
Superior quality cutters in polished steel with box joint. Blue plastic handles with double leaf springs.

- Side Cutters
- Length 130mm

Code	Description	UOM	Price
C47356	A*F Swiss (130mm)	EACH	£23.95

A*F Swiss (130mm) Heavy Duty

A*F SWITZERLAND



A*F Swiss
Heavy duty cutter specially designed for cutting hard and piano wire. Fine quality in polished in polished steel with lap joint.

- Side Cutters
- Heavy Duty (Lap Joint)
- Length 130mm

Code	Description	UOM	Price
C47361	A*F Swiss (130mm) Heavy Duty	EACH	£24.95

A*F Swiss (130mm) Smart Grip

A*F SWITZERLAND



A*F Swiss
Superb quality cutters with comfortable "Smart Grip" blue and black handles.

- Side Cutters
- Length 130mm

Code	Description	UOM	Price
C47338	A*F Swiss (130mm) Smart Grip	EACH	£25.95

Bergeon (130mm)

BERGEON



- Bergeon 2629
- Rounded tips
- Length 130mm

Code	Description	UOM	Price
P1251	Bergeon (130mm)	EACH	£37.95

Online Discounts

Cousins Swiss Style (115mm)



- Cousins Swiss Style
- Superb Swiss quality
- Side cutters
- Length 115mm
- PVC coated handles
- Polished Steel
- Box Joint
- Spring loaded (double leaf springs)

Code	Description	UOM	Price
C49674	Cousins Swiss Style (115mm)	EACH	£12.95

Cousins Swiss Style (115mm) Tungsten Carbide



- Cousins Swiss Style
- Superb Swiss quality
- Tungsten carbide jaws, heavy duty. Ideal for cutting hard metal such as watch winding stems etc.
- Side cutters
- Length 115mm
- PVC coated handles
- Polished Steel
- Box Joint
- Spring loaded (double leaf springs)

Code	Description	UOM	Price
C50140	Cousins Swiss Style (115mm) Tungsten Carbide	EACH	£14.95

Cousins Swiss Style (130mm)



- Cousins Swiss Style
- Superb Swiss quality
- Side cutters

- Length 130mm
- PVC coated handles
- Polished Steel
- Box Joint
- Spring loaded (double leaf springs)

Code	Description	UOM	Price
C49675	Cousins Swiss Style (130mm)	EACH	£12.95

Cousins Swiss Style (130mm) Square Ends



Cousins Swiss Style Superior Swiss quality cutters in polished steel with box joint. Blue plastic handles with double leaf springs.

- Side Cutters
- Length 130mm
- Spring loaded (double leaf springs)

Code	Description	UOM	Price
C48568	Cousins Swiss Style (130mm) Square Ends	EACH	£12.95

Cousins Swiss Style (130mm) Smart Grip



Cousins Swiss Style Superb Swiss quality cutters with comfortable "Smart Grip" blue and black handles.

- Side Cutters
- Length 130mm
- Spring loaded (double leaf springs)

Code	Description	UOM	Price
C48561	Cousins Swiss Style (130mm) Smart Grip	EACH	£12.95

Parallel Action Pliers

See Page 946



Faithfull (190mm) Heavy Duty



including Piano Wire.

Faithfull Tools are made to user standards by craftspeople who meet the demanding Faithfull criteria for the design and quality of each individual item.

- Heavily insulated, soft, comfortable hand grip with slip guards
- Cutting edges are hardened to 64HRC suitable for cutting some metals like piano wire, gold, silver, platinum, palladium, copper, brass, pewter, steel and bronze
- Manufactured from hardened and tempered high grade steel, grade C60 tool steel
- Its cutting capacity ranges from 0.3mm to 2.4mm
- Favourite with the precious metal buyer, cut large bangles, bracelets, rings etc especially if there is suspicion of heavy plate on non precious metals, particularly lead or copper
- Semi-flush cut
- Length 190mm
- Weight 270 grams
- Made in Germany

Code	Description	UOM	Price
C33146	Faithfull (190mm) Heavy Duty	EACH	£21.50

Knipex (200mm) Power Cut



including Piano Wire.

KNIPLEX cutters meet the highest demands in very many different applications. The breadth and depth of Knipex Cutter ensures that the best tool can always be found for every application.

KNIPLEX cutters fulfil the highest expectations in terms of performance, ergonomics and service life. The products are designed to meet the requirements of professional users, who must be able to rely on their tools in day-to-day work.

- Blackened head, plastic coated handles, developed shaped for comfortable grip
- This product can cut from 0.3mm to 3.6mm in piano wire, gold, silver, platinum, palladium, steel, copper, brass, pewter and iron
- Its lever action allows exceptional cutting performance with minimal physical effort
- Induction-hardened precision cutting edges. Edge hardness approximately 64HRC

- Material: chrome-vanadium electric steel, oil hardened construction
- Favourite with the precious metal buyer, cut large bangles, bracelets, rings etc especially if there is suspicion of heavy plate on non precious metals, particularly lead or copper
- Bevelled cut
- Length 200mm
- Weight 350g
- Made in Germany

Code	Description	UOM	Price
C33145	Knipex (200mm) Power Cut	EACH	£55.65

Value (115mm)
VALUE



- Only suitable for cutting material like solder, rubber, leather etc.
- Rounded tips
 - Side cutters
 - Length 115mm

Code	Description	UOM	Price
P4791	Value (115mm)	EACH	£3.95

Value (115mm) Chunky Grip
VALUE



- Only suitable for cutting material like solder, rubber, leather etc.
- Spring loaded sleeved arms
 - Lap joint for better leverage
 - Chunky, American style grip
 - Length 115mm
 - Heavy Duty Grip

Code	Description	UOM	Price
P40249	Value (115mm) Chunky Grip	EACH	£3.95

Value (115mm) Pointed Tips



- Only suitable for cutting material like solder, rubber, leather etc.
- Pointed tips
 - Side cutters
 - Length 115mm

Code	Description	UOM	Price
P4789	Value (115mm) Pointed Tips	EACH	£4.50

Value (130mm)
VALUE



- Only suitable for cutting material like solder, rubber, leather etc.
- Rounded tips
 - Side cutters
 - Length 130mm

Code	Description	UOM	Price
P4790	Value (130mm)	EACH	£4.95

Value (130mm) Pointed Tips
VALUE



- Only suitable for cutting material like solder, rubber, leather etc.
- Pointed tips
 - Side cutters
 - Length 130mm

Code	Description	UOM	Price
P4788	Value (130mm) Pointed Tips	EACH	£5.95

Diagonal or Side Cutters, Heavy Duty (Sprue)

Casting, Sprue, Memory Wire and Rod End Cutters.

- Designed specifically for cutting casting sprues
- The compound joint and spring action provide maximum leverage with minimum effort
- Also useful for cutting thick and hard materials
- Multi leverage with return spring in handles
- Locking system holds cutters when not in use to protect edges
- Sprue cutters are popular to cut close to work and are great for precision cutting
- Most popular with precious metal scrap buyers
- Approx. cutting capacity: Ø3mm 9ct gold

Please be advised that cutters are not guaranteed against breakage or damage.

A*F Swiss (Angled Jaws) Length 210mm



A*F Swiss - Angled Jaws - Casting, Sprue, Memory Wire and Rod End Cutters.

- Locking System
- Semi Flush Cut
- for Casting
- Length 210mm
- with Compound Lever Action

Code	Description	UOM	Price
P9573	A*F Swiss (Angled Jaws) Length 210mm	EACH	£33.95

A*F Swiss (Flat Jaws) Length 210mm



A*F Swiss - Flat Jaws - Casting, Sprue, Memory Wire and Rod End Cutters.

- Locking System
- Bevelled Cut
- for Casting
- Length 210mm
- with Compound Lever Action

Code	Description	UOM	Price
P9572	A*F Swiss (Flat Jaws) Length 210mm	EACH	£31.65

Digital Vernier Gauges

See Page 930



PRICE PROMISE GUARANTEE



Bergeon (Angled Jaws) Length 260mm



Bergeon 6599 - Angled Jaws - Casting, Sprue, Memory Wire and Rod End Cutters.

- Swiss Made
- Semi Flush Cut
- with Compound Lever Action
- Angled Jaws, Sturdy Cutters
- Double Reductions
- Locking System
- Cutting Width 22 mm
- Length 260 mm

Code	Description	UOM	Price
B0181	Bergeon (Angled Jaws) Length 260mm	EACH	£111.55

Bergeon Angled Jaws



Bergeon 6599L - Replacement Angled Jaws - Casting, Sprue, Memory Wire and Rod End Cutters.

- Swiss Made
- Replacement Jaws
- Semi Flush Cut
- Bergeon 6599L
- For Bergeon 6599 (B0181)

Code	Description	UOM	Price
B0181B	Bergeon Angled Jaws	EACH	£69.50

Bergeon Tension Spring



Bergeon 6599R - Replacement Tension Spring - Casting, Sprue, Memory Wire and Rod End Cutters.

- Swiss Made
- Replacement Tension Spring
- Bergeon 6599R
- For Bergeon 6599 (B0181)

Code	Description	UOM	Price
B0181A	Bergeon Tension Spring	EACH	£3.15

Cousins (Angled Jaws) Length 210mm



Japanese - Angled Jaws - Casting, Sprue, Memory Wire and Rod End Cutters.

- Semi Flush Cut
- for Casting
- Angled Jaws
- Length 210mm
- with Compound Lever Action
- Made in Japan

Code	Description	UOM	Price
P5009	Cousins (Angled Jaws) Length 210mm	EACH	£18.75

Value (Flat Jaws) Length 210mm



Value - Flat Jaws - Easy Grip Handles - Casting, Sprue, Memory Wire and Rod End Cutters.

- Locking Clip
- Plastic Easy Grip Handles
- Bevelled Cut
- for Casting
- Length 210mm

Code	Description	UOM	Price
P36314	Value (Flat Jaws) Length 210mm	EACH	£7.95

Diagonal or Side, Heavy Duty (for Clock Gongs & Rods)



Clock Gong/Rod (Bolt) Cutters - Faithfull

This Faithful quality high tensile cutter is suitable for cutting a wide range of materials such as gold, silver, platinum, palladium, copper, brass, mild steel, semi-hard steel, hard steel, non ferrous metals, reinforcing bars, spring wire, wrought iron and stainless steel.

The jaws/blades of these Bolt Cutters are made of heavily alloyed steel that are entirely drop forged giving a hardened blade able to withstand heavy use. The ground cutting edge is subjected to a second hardening process for maximum hardness of the cutting edge. The handles are full forged in a ribbed selection alloy steel of a very high elastic limit.

- Favourite with precious metal buyer, cut large

bangles, rings, chains, and bracelets if there is a suspicion of heavy plate on none precious metals, particularly lead or copper.

- Capacity:
- Mild Steel: 6.5 mm
 - High Tensile: 4.8 mm
 - Length: 355 mm (14" inch).
 - Type: Centre cut
 - Weight 1300g
 - Bevelled cut

Please note: never twist the cutter before the material has completely parted. This imposes undue stress on the cutter leading to a rapid deterioration in performance and eventual failure. Select materials sufficient capacity and never cut martial of a greater size then is recommended. Most materials will when they are cut safety goggles/glasses should be worn.

Code	Description	UOM	Price
C33144	Faithfull (Length 355mm)	EACH	£34.95

Diagonal or Side, Super Heavy Duty (for Clock Gongs & Rods)



Clock Gong/Rod (Bolt) Cutters - Made In Japan - HIT

The Jaws are made of drop forged high grade alloy tool steel with heat treated, precision cutting edges for longer cutting life.

These bolt cutters are suitable for cutting a wide range of materials such as gold, silver, platinum, palladium, copper, brass, mild steel, semi-hard steel, hard steel, non ferrous metals, reinforcing bars, spring wire, wrought iron and stainless steel.

Also a favourite with precious metal buyers to cut large bangles, rings, chains, and bracelets if there is a suspicion of heavy plate on none precious metals, particularly lead or copper.

Maximum hardness of material to be cut: Brinell 370/ Rockwell C42, 85 Tons/Sq. 133 Kg/square mm.

- 14, 18 or 24 inch
- Rubber grip handles
- 14 & 18 inch are clipper cut (30 degree) jaws
- 24 inch are centre cut jaws
- Stainless Steel
- Made in Japan

- Capacity:
- C39322: 7mm (Clipper cut)
 - C39323: 8mm (Clipper cut)
 - C39324: 10mm (Centre cut)

Please note: never twist the cutter before the material has completely parted. This imposes undue stress on the cutter leading to a rapid deterioration in performance and eventual failure. Select materials sufficient capacity and never cut martial of a greater

size then is recommended. Most materials will when they are cut safety goggles/glasses should be worn

Code	Description	UOM	Price
C39322	HIT (Length 355mm) Capacity 7mm	EACH	£15.95
C39323	HIT (Length 450mm) Capacity 8mm	EACH	£18.95
C39324	HIT (Length 610mm) Capacity 10mm	EACH	£22.95

End or Top (Oblique) Cutters

Oblique cutters which are similar in design to end cutters, but with jaws that are slightly offset to one side. The offset provides increased clearance

- Cutters are industry standard and are not suitable for cutting stainless steel

Please be advised that cutters are not guaranteed against breakage or damage.

A*F Swiss (115mm)



- A*F Swiss
- Oblique Cutting
- Polished Steel
- Box Joint
- Blue Plastic Covered Handles

Code	Description	UOM	Price
P32081	A*F Swiss (115mm)	EACH	£21.50

A*F Swiss (115mm) Smart Grip



A*F Swiss
Superb quality cutters with comfortable "Smart Grip" blue and black handles.

- Oblique Cutters
- Length 115mm

Code	Description	UOM	Price
C47346	A*F Swiss (115mm) Smart Grip	EACH	£25.75

Bergeon (110mm) Specialist Hairspring



Bergeon 5906.17 - Swiss Made

Precision nippers for cutting hairsprings and soft metals

- Oblique Nosed
- Length 110mm

The criterion adopted by the manufacturers to define soft metals is copper wire diameter Ø1.20mm & similar. These cutters are not guaranteed against brass, steel, nickel, gold or silver alloys

Code	Description	UOM	Price
C47383	Bergeon (110mm) Specialist Hairspring	EACH	£172.50

Bergeon (130mm)



- Bergeon 2628
- Swiss Made
- Oblique end cutting
- Polished steel
- Plastic covered Handles
- Box Joint

Code	Description	UOM	Price
P1255	Bergeon (130mm)	EACH	£38.75

Cousins Swiss Style (115mm)



Cousins Swiss Style

- Superb Swiss quality
- Oblique Cutting
- Length 115mm
- PVC coated handles
- Polished Steel
- Box Joint
- Spring loaded (double leaf springs)

Code	Description	UOM	Price
C49673	Cousins Swiss Style (115mm)	EACH	£11.95

Cousins Swiss Style (130mm)



Cousins Swiss Style

- Superb Swiss quality
- Oblique Cutting
- Length 130mm
- PVC coated handles
- Polished Steel
- Box Joint
- Spring loaded (double leaf springs)

Code	Description	UOM	Price
C49667	Cousins Swiss Style (130mm)	EACH	£13.95

Cousins Swiss Style (130mm) Metal Grip



Cousins Swiss Style

- Superb Swiss quality
- Oblique Cutting
- Length 130mm
- Metal handles
- Polished Steel
- Box Joint
- Blue Plastic Covered Handles
- Spring loaded (double leaf springs)

Code	Description	UOM	Price
C50635	Cousins Swiss Style (130mm) Metal Grip	EACH	£13.95

Wooden Plier Stand

See Page 677



Cousins Swiss Style (130mm) Smart Grip



Cousins Swiss Style

- Superb Swiss quality
- Oblique Cutting
- Length 130mm
- Comfortable "Smart Grip" handles
- Polished Steel
- Box Joint
- Blue Plastic Covered Handles
- Spring loaded (double leaf springs)

Code	Description	UOM	Price
C48563	Cousins Swiss Style (130mm) Smart Grip	EACH	£14.95

End or Top (Straight) Cutters

Super Flush Cut: Take a look at our excellent range of top cutters, ideal for precision fine cutting and getting a very close cut that those side cutters might struggle with.

- The cutting edges of these cutters are set at right angles to provide easier access to tight areas.
- Better suited than diagonal cutters for snipping protruding wire ends
- Also available are oblique cutters which are similar in design to end cutters, but with jaws that are slightly offset to one side. The offset provides increased clearance
- Cutters are industry standard and are not suitable for cutting stainless steel
- Value cutters are only suitable for cutting material like solder, rubber, leather etc.

Please be advised that cutters are not guaranteed against breakage or damage.

A*F Swiss (115mm)



A*F Swiss

Superior quality cutters in polished steel with box joint. Blue plastic handles with double leaf springs.

- Straight Cutters
- Length 115mm

Code	Description	UOM	Price
C47348	A*F Swiss (115mm)	EACH	£21.95

A*F Swiss (115mm) Smart Grip



A*F Swiss

Superb quality cutters with comfortable "Smart Grip" blue and black handles.

- Straight Cutters
- Length 115mm

Code	Description	UOM	Price
C47347	A*F Swiss (115mm) Smart Grip	EACH	£26.95

A*F Swiss (130mm) Tungsten Carbide



A*F Swiss

Heavy duty end cutter with tungsten carbide cutting edges. Ideal for cutting hard metal such as watch winding stems etc.

- Plastic Covered Handles
- Box joint
- Polished Steel
- with Leaf Springs
- Length 130mm

Code	Description	UOM	Price
C47109	A*F Swiss (130mm) Tungsten Carbide	EACH	£29.95

Bergeon (110mm) Specialist Hairspring



Bergeon 5906.16 - Swiss Made

Precision nippers for cutting hairsprings and soft metals

- Straight Nosed
- Length 110mm

The criterion adopted by the manufacturers to define soft metals is copper wire diameter Ø1.20mm & similar. These cutters are not guaranteed against brass, steel, nickel, gold or silver alloys

Code	Description	UOM	Price
C47382	Bergeon (110mm) Specialist Hairspring	EACH	£169.95

Bergeon (130mm)



Bergeon 2627

- Swiss Made
- Straight end cutting
- Polished steel
- Plastic covered arms
- Length 130mm
- Box Joint

Code	Description	UOM	Price
P1254	Bergeon (130mm)	EACH	£38.95

Bergeon (140mm) Heavy Duty



Bergeon 6764

- Straight end cutting
- Polished steel
- Plastic covered arms
- Length 140mm
- Box Joint

Cutting Capacity:

- Copper up to Ø4.0mm
- Steel up to Ø1.5mm

Code	Description	UOM	Price
C47384	Bergeon (140mm) Heavy Duty	EACH	£31.70



Cousins Swiss Style (115mm)



- Cousins Swiss Style
- Superb Swiss quality pliers
- PVC coated handles
- Straight end cutting
- Polished steel
- Box joint
- Length 115mm
- Spring loaded (double leaf springs)

Code	Description	UOM	Price
C49671	Cousins Swiss Style (115mm)	EACH	£11.95

Cousins Swiss Style (130mm)



- Cousins Swiss Style
- Superb Swiss quality pliers
- PVC coated handles
- Straight end cutting
- Polished steel
- Box joint
- Length 130mm
- Spring loaded (double leaf springs)

Code	Description	UOM	Price
C49672	Cousins Swiss Style (130mm)	EACH	£12.95

Cousins Swiss Style (130mm) Smart Grip



Cousins Swiss Style

Superb Swiss quality cutters with comfortable "Smart Grip" blue and black handles.

- Straight Cutters
- Length 130mm
- Straight end cutting
- Polished steel
- Box joint

Code	Description	UOM	Price
C48562	Cousins Swiss Style (130mm) Smart Grip	EACH	£12.95

Cousins Swiss Style (130mm) Tungsten Carbide



- Cousins Swiss Style
- Superb Swiss quality pliers
- Tungsten carbide jaws, heavy duty. Ideal for cutting hard metal such as watch winding stems etc.
- PVC coated handles
- Straight end cutting
- Polished steel
- Box joint
- Length 130mm
- Spring loaded (double leaf springs)

Code	Description	UOM	Price
C49676	Cousins Swiss Style (130mm) Tungsten Carbide	EACH	£14.75

Value (115mm) Jaws 15mm



Only suitable for cutting material like solder, rubber, leather etc.

- Jaw Width 15mm
- Length 115mm
- Sprung Loaded

Code	Description	UOM	Price
P4794	Value (115mm) Jaws 15mm	EACH	£4.95



Value (115mm) Jaws 20mm



Only suitable for cutting material like solder, rubber, leather etc.

- Jaw Width 20mm
- Length 115mm
- Sprung Loaded

Code	Description	UOM	Price
P4793	Value (115mm) Jaws 20mm	EACH	£7.95

Value (115mm) Chunky Grip



Only suitable for cutting material like solder, rubber, leather etc.

- Heavy Duty Grip
- Spring loaded sleeved arms
- Lap joint for better leverage
- Chunky, American style grip
- Jaw Width 12mm
- Length 100mm

Code	Description	UOM	Price
P40251	Value (115mm) Chunky Grip	EACH	£3.95

Value (115mm) for Stems



For Watch Winding Stems (limited use)

- Plastic covered Handles
- Length 100mm
- Non EU

Code	Description	UOM	Price
P36103	Value (115mm) for Stems	EACH	£5.95

**End or Top Cutters,
Heavy Duty**

Cutters for end castings, sprues, memory wire, watch mesh (milanais) bracelets and rod ends.

- Our end cutters are popular as they can cut close to work, making them great for precision cutting
- Multi leverage with return spring in handles
- Most popular with precious metal scrap buyers

Please be advised that cutters are not guaranteed against breakage or damage.

Bergeon Swiss (Jaws 22mm x Length 240mm)



Bergeon 6496 - Cutters for end castings, sprues, memory wire, watch mesh (milanais) bracelets and rod ends.

- The original mesh bracelet cutter/trimmer used for generations by the top Swiss watch houses
- Hardened steel cutting jaws make a clean cut with one closing action
- The pressure exerted is multiplied many times by the unique lever design
- It therefore requires minimum effort from the user
- Approx. cutting capacity: Ø3mm 9ct gold
- Semi Flush
- Locking System
- Length 240mm
- Jaws Width 22mm

Code	Description	UOM	Price
B0139	Bergeon Swiss (Jaws 22mm x Length 240mm)	EACH	£97.10

Cousins (Jaws 16mm x Length 210mm)



Japanese - Cutters for end castings, sprues, memory wire, watch mesh (milanais) bracelets and rod ends.

- Locking System
- Approx. cutting capacity: Ø3mm 9ct Gold
- Semi Flush
- Length 210mm
- Jaw Width 16mm

• Opening 4mm

Code	Description	UOM	Price
P5167	Cousins (Jaws 16mm x Length 210mm)	EACH	£19.95

Cousins Swiss Style (Jaws 22mm x Length 240mm) Tungsten Carbide



- Cousins Swiss Style
- Superb Swiss quality pliers
- Tungsten carbide jaws, heavy duty. Ideal for cutting hard metal such as watch winding stems etc.
- Easy grip handles
- Straight end cutting
- Polished steel
- Box joint
- Length 240mm
- Spring loaded (double leaf springs)

Code	Description	UOM	Price
C50139	Cousins Swiss Style (Jaws 22mm x Length 240mm) Tungsten Carbide	EACH	£59.95

Lindstrom (80-Series) Cutters

The technology that truly "started it all"

This Lindstrom 80-Series remains the top choice for the traditional user. This range of cutters offers unsurpassed cutting capacity covering a wide range of wire dimensions and types.

Cuts:

- Micro Bevel Cut
- Flush Cut
- Ultra Flush Cut
- See PDF for full explanation and pictures

Handling:

- All cutters from the 80-Series are equipped with a precision screw joint
- This minimizes friction
- Maximizes alignment of cutting edges

Hardness:

- Lindstrom guarantee 63 to 65 Rockwell hardness
- Lindstrom state that their cutters are suitable for copper wire from Ø0.1 to Ø1.0mm. This can be used as a guide for other materials
- Cutters are industry standard and are not suitable for cutting stainless steel

Specifications:

- Cut (Jaw Length) Lindstrom number

Please be advised that cutters are not guaranteed against breakage or damage

Click website "More Information" & "PDFs" for full specification.

Flush Cut (8mm) Lindstrom 8131



- 8mm cutting length
- 8mm wide jaws
- Flush cut
- Lindstrom 8131

Code	Description	UOM	Price
P19495	Flush Cut (8mm) Lindstrom 8131	EACH	£33.75

Flush Cut (10mm) Lindstrom 8141



- 10mm cutting length
- 10mm wide jaws
- Flush cut
- Lindstrom 8141

Code	Description	UOM	Price
P19498	Flush Cut (10mm) Lindstrom 8141	EACH	£28.95

Flush Cut (12.5mm) Lindstrom 8151



- 12.5mm cutting length
- 12.5mm wide jaws
- Flush cut
- Lindstrom 8151

Code	Description	UOM	Price
P19501	Flush Cut (12.5mm) Lindstrom 8151	EACH	£30.50

Pliers with Plastic Jaws



See Page 943

Flush Cut (16mm) Lindstrom 8161



- 16mm cutting length
- 16mm wide jaws
- Flush cut
- Lindstrom 8161

Code	Description	UOM	Price
P19504	Flush Cut (16mm) Lindstrom 8161	EACH	£36.75

Micro Bevel Cut (8mm) Lindstrom 8130



- 8mm cutting length
- 8mm wide jaws
- Micro Bevel Cut
- Lindstrom 8130

Code	Description	UOM	Price
P19494	Micro Bevel Cut (8mm) Lindstrom 8130	EACH	£36.50

Micro Bevel Cut (10mm) Lindstrom 8140



- 10mm cutting length
- 10mm wide jaws
- Micro Bevel Cut
- Lindstrom 8140

Code	Description	UOM	Price
P19497	Micro Bevel Cut (10mm) Lindstrom 8140	EACH	£29.95

Micro Bevel Cut (12.5mm) Lindstrom 8150



- 12.5mm cutting length
- 12.5mm wide jaws
- Micro Bevel Cut
- Lindstrom 8150

Code	Description	UOM	Price
P19500	Micro Bevel Cut (12.5mm) Lindstrom 8150	EACH	£34.95

Micro Bevel Cut (16mm) Lindstrom 8160



- 16mm cutting length
- 16mm wide jaws
- Micro Bevel Cut
- Lindstrom 8160

Code	Description	UOM	Price
P19503	Micro Bevel Cut (16mm) Lindstrom 8160	EACH	£32.50

Ultra Flush Cut (8mm) Lindstrom 8132



- 8mm cutting length
- 8mm wide jaws
- Ultra flush cut
- Lindstrom 8132

Code	Description	UOM	Price
P19496	Ultra Flush Cut (8mm) Lindstrom 8132	EACH	£37.15

Ultra Flush Cut (10mm) Lindstrom 8142



- 10mm cutting length
- 10mm wide jaws
- Ultra flush cut
- Lindstrom 8142

Code	Description	UOM	Price
P19499	Ultra Flush Cut (10mm) Lindstrom 8142	EACH	£32.75

Ultra Flush Cut (12mm) Lindstrom 8152



- 12.5mm cutting length
- 12.5mm wide jaws
- Ultra flush cut
- Lindstrom 8152

Code	Description	UOM	Price
P19502	Ultra Flush Cut (12mm) Lindstrom 8152	EACH	£32.95

Ultra Flush Cut (16mm) Lindstrom 8162



- 16mm cutting length
- 16mm wide jaws
- Ultra flush cut
- Lindstrom 8162

Code	Description	UOM	Price
P19505	Ultra Flush Cut (16mm) Lindstrom 8162	EACH	£33.95



Lindstrom Lead Catcher



- For securing cut off wire pieces
- For Lindstrom cutters 8130, 8131 & 8132

Code	Description	UOM	Price
C46266	Lindstrom Lead Catcher	EACH	£3.95

Maun Cutters (Made in UK) Heavy Duty

Maun Cutters established since 1944 - Made in UK - Semi Flush Cut

Maun Cutters comprise of compound lever action giving considerable mechanical advantage cuttings operations. Anti-rust finish with bright nickel plated handles and fully treated chemically anti glare blacked cutting jaws. This is especially useful when the pressure exerted should be applied with exactly opposite force without slippage.

Cutters with cutting jaws are constructed of high quality materials which are to provide exceptional durability and give you extra comfort plus power because of the unique compound lever action pliers construction. Also available in plastic-coated cushion grip handles provides maximum comfort

The essential features of all Maun cutting nippers are the accuracy of the cutting edges and the quality of the steel and heat treatment.

The compound lever design gives good mechanical advantage, allowing the plier to cut piano wire with handle loads significantly less than conventional forged pliers of equivalent size.

Please note cutters are industry standard and are not suitable for cutting stainless steel

End Cutters (Length 150mm)



Maun 3010.150 - Made in UK

- Length: 150mm
- Maximum Hard Wire Cutting Ø2.00mm
- Maximum Opening: 4mm

Code	Description	UOM	Price
P33215	End Cutters (Length 150mm)	EACH	£28.25

Side Cutters (Length 140mm) with PVC Sleeves



Maun 2999.140 - Made in UK

- Length: 140mm
- Maximum Hard Wire Cutting Ø2.00mm
- PVC Sleeves

Code	Description	UOM	Price
P33208	Side Cutters (Length 140mm) with PVC Sleeves	EACH	£26.85

Side Cutters (Length 160mm) with PVC Sleeves



Maun 2999.160 - Made in UK

- Length: 160mm
- Maximum Hard Wire Cutting Ø2.00mm
- PVC Sleeves

Code	Description	UOM	Price
P33207	Side Cutters (Length 160mm) with PVC Sleeves	EACH	£29.25

Side Cutters (Length 160mm)



Maun 2990.160 - Made in UK

- Length: 160mm
- Maximum Hard Wire Cutting Ø2.00mm

Code	Description	UOM	Price
P33209	Side Cutters (Length 160mm)	EACH	£28.20

Side Cutters (Length 220mm) with PVC Sleeves



Maun 3018.200 - Made in UK

- Length: 220mm
- Maximum Hard Wire Cutting Ø2.50mm

Code	Description	UOM	Price
P33216	Side Cutters (Length 220mm) with PVC Sleeves	EACH	£69.95

Swisotech (Chunky Handle) Cutters

High Quality - Ergonomic Chunky Handles - Swiss Made Cutters

Cuts:

- Micro Bevel Cut - Flush Cut - Ultra Flush Cut
- See PDF for full explanation and pictures

Handling:

- Ergonomic, easy to operate & comfortable chunky handles
- Spring loaded stainless steel box joint
- All cutters are equipped with a precision screw joint
- Maximizes alignment of cutting edges
- Each cutter comes complete with protective jaw cap

Hardness:

- 63 Rockwell hardness
- For suitable cutting diameters please see additional information on each cutter
- Cutters are industry standard and are not suitable for cutting stainless steel

Specifications:

- Cut x (Cut Range) x Jaw Length

Please be advised that cutters are not guaranteed against breakage or damage

Flush Cut (Ø0.1 to Ø1.2mm) 10mm swisotech®



Swisotech S8141

- Suitable for copper wire from Ø0.1 to Ø1.2mm
- This can be used as a guide for other materials
- Flush Cut

Code	Description	UOM	Price
P44184	Flush Cut (Ø0.1 to Ø1.2mm) 10mm	EACH	£24.50

**Flush Cut (Ø0.2 to Ø1.6mm)
12.5mm**

swisotech®



Swisotech S8151
 • Suitable for copper wire from Ø0.2 to Ø1.6mm
 • This can be used as a guide for other materials
 • Flush Cut

Code	Description	UOM	Price
P44187	Flush Cut (Ø0.2 to Ø1.6mm) 12.5mm	EACH	£25.95

Flush Cut (Ø0.4 to Ø2.5mm) 16mm

swisotech®



Swisotech S8161
 • Suitable for copper wire from Ø0.4 to Ø2.5mm
 • This can be used as a guide for other materials
 • Flush Cut

Code	Description	UOM	Price
P44190	Flush Cut (Ø0.4 to Ø2.5mm) 16mm	EACH	£31.95

**Micro Bevel Cut (Ø0.1 to Ø1.2mm)
10mm**

swisotech®



Swisotech S8140
 • Suitable for copper wire from Ø0.2 to Ø1.2mm
 • This can be used as a guide for other materials
 • Micro Bevel Cut

Code	Description	UOM	Price
P44183	Micro Bevel Cut (Ø0.1 to Ø1.2mm) 10mm	EACH	£24.95

**Micro Bevel Cut (Ø0.3 to Ø1.6mm)
12.5mm**

swisotech®



Swisotech S8150
 • Suitable for copper wire from Ø0.3 to Ø1.6mm
 • This can be used as a guide for other materials
 • Micro Bevel Cut

Code	Description	UOM	Price
P44186	Micro Bevel Cut (Ø0.3 to Ø1.6mm) 12.5mm	EACH	£24.95

**Micro Bevel Cut (Ø0.5 to Ø3.0mm)
16mm**

swisotech®



Swisotech S8160
 • Suitable for copper wire from Ø0.5 to Ø3.0mm
 • This can be used as a guide for other materials
 • Micro Bevel Cut

Code	Description	UOM	Price
P44189	Micro Bevel Cut (Ø0.5 to Ø3.0mm) 16mm	EACH	£25.95

**Ultra Flush Cut (Ø0.1 to Ø1.0mm)
10mm**

swisotech®



Swisotech S8142
 • Suitable for copper wire from Ø0.1 to Ø1.0mm
 • This can be used as a guide for other materials

• Ultra Flush Cut

Code	Description	UOM	Price
P44185	Ultra Flush Cut (Ø0.1 to Ø1.0mm) 10mm	EACH	£29.95

**Ultra Flush Cut (Ø0.2 to Ø1.2mm)
12.5mm**

swisotech®



Swisotech S8152
 • Suitable for copper wire from Ø0.2 to Ø1.2mm
 • This can be used as a guide for other materials
 • Ultra Flush Cut

Code	Description	UOM	Price
P44188	Ultra Flush Cut (Ø0.2 to Ø1.2mm) 12.5mm	EACH	£31.95

**Ultra Flush Cut (Ø0.4 to Ø2.5mm)
16mm**

swisotech®



Swisotech S8162
 • Suitable for copper wire from Ø0.4 to Ø2.5mm
 • This can be used as a guide for other materials
 • Ultra Flush Cut

Code	Description	UOM	Price
P44191	Ultra Flush Cut (Ø0.4 to Ø2.5mm) 16mm	EACH	£36.95

Belt Sander Attachment, Foredom

See Page 985



Angle Grinder Attachment, Foredom

See Page 985



Xuron (USA Made) Cutters



Timeless engineered hand tools

Made in U S A - Full Flush

Xuron patented Micro-Shear cutting action provide a super flush cut (no pinch or bevel).

Xuron are considered the best of the best in its range of pliers and cutters in the world, take a glance at our large range, there is always something to suit you.

Xuron Corporation is one of the world's leading manufacturers of ergonomic precision-grade hand tools for jewellery, silversmith arts/craft model maker, electronics, aerospace, plastic moulding, hobbies, craft, floral and fishing Industries.

Xuron holds numerous domestic and international patents, including an inventor's patent for the original Micro-Shear® flush cutter and its unique cutting action.

What is a Micro-Shear®?

The term Micro-Shear® describes the blade bypass shear cutting action that is unique to all Xuron cutters. Shear cutting reduces cutting effort (as compared to traditional compression cutting) and extends blade life because the sharp edges are not meeting edge to edge. Shear cutting also produces clean, flat cuts.

Xuron tools are manufactured in Saco, Maine, where quality, an outstanding work ethic and flawless craftsmanship are a long-time tradition.

Cutters are industry standard and are not suitable for cutting stainless steel

Hard Wire Cutter, Xuron 2193



Xuron 2193
HWAC stands for Hard Wire and Cable. The HWAC is

rated for hardened wire, music wire, memory wire and throttle cable. So the cutting of precious or none metals such as gold, silver, platinum, copper, brass etc is effortless and exceptionally effective. It does not require any special cutting technique. This is an ideal tool for craftspeople that need to cut a wide variety of materials. Use our HWAC cutter like any cutter

- Place the material between the jaws at the desired location and squeeze on the handles.
- Cutting effort is minimal due to the tools' shearing action.
- Cushioned Xuron-Rubber™ grips for comfort and Light Touch™ spring action returns to its open position.
- Overall length 152mm (6" inch)
- Jaw Length 13mm
- Flush cuts copper & 9ct wires up to 3.00mm
- Flush cuts hard wires (platinum) up to 1.60mm

Code	Description	UOM	Price
P33221	Hard Wire Cutter, Xuron 2193	EACH	£9.95

Scissor Cutter, Xuron 9180NS



Xuron 9180NS esigned to cut through precious and non-precious metals, the 9180 precision shear features high carbon, smooth steel blades.

It is user friendly while optimizing durability and precision, the 9180 fits comfortably in both hands.

- Ergonomic Xuron-Rubber™ non-slip grips cushion the hand
- Elimination of finger loops ensures positioning flexibility to help alleviate fatigue
- A convenient return spring re-opens the shear after each cut
- Ideal for all applications that involve extended cutting time
- Overall length 152mm (6" inch)
- Jaw Length 21.5mm
- Flush cuts copper & 9ct wires up to 2.00mm
- Flush cuts copper & 9ct sheet up to 1.00mm
- High Durability
- Smooth Blades

Code	Description	UOM	Price
P33224	Scissor Cutter, Xuron 9180NS	EACH	£11.95

Side Flush Cutter, Xuron 2175, Best Seller



Xuron 2175
A large, strong and durable diagonal cutter ideal for use in a variety of industries.

It's perfect cutting fine wire such as gold silver copper brass etc. Delivers a clean, square cut with minimal effort while our Light Touch™ return spring speeds work. Head shape allows excellent sight lines to help increase precision. Cushioned, Xuron-Rubber™ grips add comfort during extended work periods. Glare eliminating finish reduces eye strain.

- The Most Popular Flush Cutter
- 152mm overall length for smaller hands and maximum manoeuvrability.
- 12mm Jaw Length
- Flush cuts copper & 9ct wires up to 2.50mm
- 20 degree angle
- Maxi-Shear

Code	Description	UOM	Price
P8872	Side Flush Cutter, Xuron 2175, Best Seller	EACH	£8.50

Side Flush Cutter (fine), Xuron 170-II



Xuron 170-II Their shearing cut requires only about half the effort to cut a wire as that required by a conventional compression type cutter.

- Advanced ergonomic shape Xuron-Rubber™ grips
- A glare eliminating black finish
- Light weight
- Light Touch™ return spring
- Manufactured from high carbon steel
- Rockwell hardness 54-56C
- Produces a flat, flush cut
- Its slim profile increases access in high density area
- 127mm overall length for smaller hands and maximum manoeuvrability
- 9mm Jaw Length
- Flush cuts copper & 9ct wires up to 1.50mm
- 20 degree angle

Code	Description	UOM	Price
P33223	Side Flush Cutter (fine), Xuron 170-II	EACH	£4.50

Side Flush Cutter (LX), Xuron



Xuron 90174
• LX shears are premium grade Micro-Shear® flush cutters offering added capacity and durability.
• Their high carbon steel blades are precision ground to ultra sharp cutting edges.
• LX Series Micro-Shear® flush cutters receive a

- unique, state of the art heat treating process for a Rockwell hardness of 57-59 C.
- The result is a tough, precise, durable flush cutter capable of reliably and economically cutting precious or none metals such as gold silver platinum copper brass etc.
- Shears feature ergonomically shaped, non-slip Xuron-Rubber™ grips, a glare resistant bright finish, and Light Touch™ return spring.
- Our patented Micro-Shear® cutting action combined with precision ground cutting edges, extra tough high carbon steel blades, an ultra slim profile for access in high density areas and the same enhanced ergonomic shape.
- 127mm overall length for smaller hands and maximum manoeuvrability.
- 9mm Jaw Length
- Flush cuts copper & 9ct wires up to 2.00mm
- 20 degree angle

Code	Description	UOM	Price
P33222	Side Flush Cutter (LX), Xuron	EACH	£7.95

Shears (Jewellers)

- For cutting sheet metal & snipping wire
- Sharp and sturdy
- Straight or curved blades
- PVC coated handles
- Please be advised that cutters are not guaranteed against breakage or damage
- Cutters are industry standard and are not suitable for cutting stainless steel
- Bergeon Swiss, Cousins Swiss Style or Value

Bergeon, Straight Blade



- Bergeon 2374
- Straight shears with varnished handles
- Length 175mm
- For cutting sheet metal & snipping wire
- Sharp and sturdy

Code	Description	UOM	Price
P1252	Bergeon, Straight Blade	EACH	£21.95

Cousins Swiss Style, Curved Blade



Cousins Swiss Style

- Superb Swiss quality
- Jewellers shears
- Curved blade
- Length 180mm
- PVC coated handles
- Polished Steel

Code	Description	UOM	Price
C52038	Cousins Swiss Style, Curved Blade	EACH	£11.95

Cousins Swiss Style, Straight Blade



- Cousins Swiss Style
- Superb Swiss quality
- Jewellers shears
- Straight blade
- Length 180mm
- PVC coated handles
- Polished Steel

Code	Description	UOM	Price
C52039	Cousins Swiss Style, Straight Blade	EACH	£11.95

Value, Curved Blade



- Length 150mm
- For cutting sheet metal & snipping wire
- Sharp and sturdy
- Handle colour may vary

Code	Description	UOM	Price
P4797	Value, Curved Blade	EACH	£4.50

Value, Curved Blade, Spring Loaded

- Length 150mm
- For cutting sheet metal & snipping wire
- Sharp and sturdy
- Spring loaded
- With locking mechanism
- Handle colour may vary

Code	Description	UOM	Price
P54122	Value, Curved Blade, Spring Loaded	EACH	£4.95

Value, Straight Blade



- Length 150mm
- For cutting sheet metal & snipping wire
- Sharp and sturdy
- Handle colour may vary

Code	Description	UOM	Price
P4796	Value, Straight Blade	EACH	£4.50

Value, Straight Blade, Spring Loaded

- Length 150mm
- For cutting sheet metal & snipping wire
- Sharp and sturdy
- Spring loaded
- With locking mechanism
- Handle colour may vary

Code	Description	UOM	Price
P54123	Value, Straight Blade, Spring Loaded	EACH	£4.95

Shears (Jewellers) Gilbow

The original Irwin Gilbow cutting snips were first designed in 1924 and have dominated the sheet metal cutting industry to such an extent that today, snips and shears are referred to as "Gilbows".

These Irwin Gilbow cutting snips have accurately ground edges that ensure the material being cut does not slip out of the jaws and become damaged. The hollow ground jaw faces provide a longer life to the cutting edge.

Gilbow cutters are jointed with a nut and bolt design essential in ensuring the longest possible life of the joint, whilst keeping a good easy smooth cutting movement.

Irwin Gilbow snips and shears have a great cutting capability which is much greater than the strength of the user and will provide a good, clean, easy cut edge to any work piece.

We have selection of various sizes and shaper to cater for all sorts of cutting jobs. Straight cutters are traditional, but take a look at a curved set. Very easy to cut out circles and shapes with there unique curved blades.

- Can cut mild steel and non-ferrous metals up to 1.2mm (18g) thick
- Can cut stainless steel up to 0.46mm (23g) thick

Made in United Kingdom

Please note cutters are industry standard and are not suitable for cutting stainless steel



175mm Straight Gilbow Cutters



- Overall length 175mm
- Straight (flat) blade
- Accurately ground edges
- Weight: 170 grams

Code	Description	UOM	Price
C33149	175mm Straight Gilbow Cutters	EACH	£19.95

175mm Curved Gilbow Cutters



- Overall length 175mm
- Curved blade
- Accurately ground edges
- Weight: 170 grams

Code	Description	UOM	Price
C33150	175mm Curved Gilbow Cutters	EACH	£24.95

200mm Straight Gilbow Cutters



- Overall length 200mm
- Straight (flat) blade
- Accurately ground edges
- Weight: 265 grams

Code	Description	UOM	Price
C33151	200mm Straight Gilbow Cutters	EACH	£21.95

200mm Curved Gilbow Cutters



- Overall length 200mm
- Curved blade
- Accurately ground edges
- Weight: 265 grams

Code	Description	UOM	Price
C33148	200mm Curved Gilbow Cutters	EACH	£27.95

Cutters - Guillotine Cutters

One of the most useful tools you will find in your workshop helping you cut sheet and wire metal to size accurately and quickly.

- Guillotines have been used in metal workshops for many generations, being one of the most traditional and common tools found in the industry
- Guillotines help the operators save a great deal of their energy and time
- Durston guillotine or non branded

Please be advised that cutters are not guaranteed against breakage or damage.

Wire (up to Ø1.5mm) Guillotine



- Bench top wire guillotine
- Precision ground with hardened steel blade.
 - Sturdy metal construction that can be screwed to the bench or work surface (screws not supplied).
 - Efficiently cuts wire to your desired length up to 60mm using the sliding rail. Simply lock the slide to the length of wire you would like to cut.
 - Cuts wire from 0 – 1.5mm
 - Comfortable plastic coated handle makes this tool easy to use.
 - Very popular for jewellers, silversmiths, light engineers, model makers and for arts and crafts

Size: 100mm x 120mm x 180mm

Code	Description	UOM	Price
G9471	Wire (up to Ø1.5mm) Guillotine	EACH	£19.95

30mm (Chain Cutter) Guillotine

Essential tool for the workshop particularly for watch and clock makers, jewellers, metal craft and model makers

- Applies a precise straight cut, extra flush
- With a beveled-cylinder cutting tool very useful for cutting mesh bands on watches/bracelet, solder wire and small pieces of sheet metal.
- The long handle provides maximum cutting leverage.
- Create various shapes, squares, rectangles, triangles and hex angles for your jewellery designs
- Cut wire or rod perfectly to an extra flush cut, no need for filing afterwards
- Will cut all sorts of metals; gold, silver, copper, brass, platinum, steel etc.
- Fitted with a sheet wire/rod securing adjustable plate
- Cast iron body base with steel construction parts
- Four bench screw mounting points
- Cutting capacity (approx): Sheet 1mm, rod/wire up to 2mm



Dimensions:

- 30mm wide cutting blade
- Base 135 x 100 x 65mm
- Handle length 250mm
- Weight: 2.2kg

Code	Description	UOM	Price
G34939	30mm (Chain Cutter) Guillotine	EACH	£29.95

150mm (Heavy Duty) Guillotine, E.U.



Heavy duty guillotine shear

- 150mm blades
- Cuts up to 3mm sheet and wire
- Sturdy metal construction can be bolted to your bench or work surface (bolts not supplied)
- 600mm handle provides leverage for easy use
- Very popular for jewellers, silversmiths, light engineers, model makers and for arts and crafts
- Made in E.U.

Size: 850mm x 290mm x 130mm
Weight: 12kg

Code	Description	UOM	Price
G44144	150mm (Heavy Duty) Guillotine, E.U.	EACH	£175.00



150mm Spare Blade, E.U.

- Spare blade for G44144
- 150mm blade
- Includes bottom plate and blade



Code	Description	UOM	Price
G48190	150mm Spare Blade, E.U.	EACH	£68.95

150mm (Heavy Duty) Guillotine, India

Bench Sheet and Wire Sear Cutter

- Precision Ground, hardened tool steel blades 6 inches (150mm)
- Sturdy metal construction can be bolted to your bench or work surface (bolts not supplied)
- Cuts up to 3mm sheet and wire
- 600mm handle provides leverage for easy use
- Very popular for jewellers, silversmiths, light engineers, model makers and for arts and crafts



Dimensions:

- Blade Width 150mm
- Size: 850mm x 290mm x 130mm
- Weight: 12kg

Code	Description	UOM	Price
B31892	150mm (Heavy Duty) Guillotine, India	EACH	£99.95

300mm (Heavy Duty) Guillotine, Durston

- Durston Guillotine, Heavy Duty
- Will cut up to 300mm wide by 4mm (8 gauge) thick non-ferrous metal and 2.5mm (12 gauge) mild steel.
- Precision ground, hardened and tempered blade.
- Blade can be turned round 4 times before it needs sharpening, so will give a lifetime of work for many users.
- Open back, allowing for any length of sheet.
- Long pulling bar making cutting easy.
- Guard situated at front of blade.
- Easy to read adjustable ruler connected to back stop.
- Squared front with 2 tightening screws
- Durston 1195
- Made in UK



Specifications:

- Weight: 52kg
- Width of Cut: 300mm
- Cut Capacity, Mild Steel: 2.5mm
- Cut Capacity, Non-Ferrous: 4.0mm
- Main Base Dimensions in mm: 470 x 210

Code	Description	UOM	Price
G32250	300mm (Heavy Duty) Guillotine, Durston	EACH	£795.00

Clock Paper Dial Cutter



- Excellent, adjustable paper dial cutter that cuts perfect circles from Ø2" to 16"
- Simply adjust to preferred size by sliding the brass lock into position
- Place one point on the paper where you want the centre of the circle to be and spin the cutter around 360° to form your perfect circle

Code	Description	UOM	Price
C32061	Clock Paper Dial Cutter	EACH	£8.95

Cutting Knife, Bergeon



- Bergeon 1036
- With synthetic, gel type handle.
- Length 145mm

Code	Description	UOM	Price
K0891	Bergeon 1036 Cutting Knife	EACH	£17.95

Scalpel, All Purpose



Scalpel - Modeller's - Made in USA

Improved with a soft-grip handle, this is the most popular style knife of its type. New technology assures sharper blades of better temper than ever before. Knurled tightening knob for the chuck.

- Fast, easy & simple blade replacement
- Simply rotate the knurled bottom cap and the four jaw chuck holding the blade will release
- Non slip, soft-grip handle, giving excellent grip
- Made in the USA

Dimensions:

- Overall length: 150mm
- Blade cutting edge size: 25mm
- Weight: 11g

Code	Description	UOM	Price
S1478	Modeller's Scalpel	EACH	£3.75
S1479	Modeller's Scalpel Blades	PACK*5	£1.85

Precision Scalpel



Scalpel Set - Comfort Handle - Multi Blade

This kit is essential for jobbing, its uses vary from cutting in wax models, creating air holes during the delft casting process, etching, scribing, retouching stencil layouts and paste tips.

- Comfort handle
- Includes 5 x SK5 blades
- With safety cap

Code	Description	UOM	Price
K47888	Precision Scalpel with Comfort Grip	EACH	£3.50

Scalpel (Blades, large fitting) Sterilised

Scalpel - Surgical - Sterilised - Universal Large Fitting Blades

- Handles, large fitting and blades
- Universal blades, large fitting
- Fitting gap 25mm long
- Quality sterilised surgical blades
- Packs of 100
- Single use
- Carbon steel
- Indian

Caution: Blades are incredibly sharp

Scalpel, Metal Handle (large fitting) VALUE



Takes universal blades, large fitting

- Length 140mm
- Steel
- For Blades 20, 21, 22 & 24

Code	Description	UOM	Price
S37166	Scalpel, Metal Handle (large fitting)	EACH	£1.50

No.20 Sterilised Universal Blades, Large Fitting VALUE



Universal blades, large fitting - Fitting gap 25mm long

- For Scalpel Handle S37166
- Quality sterilised surgical blades
- Packs of 100
- Single use
- Carbon steel
- Indian

Code	Description	UOM	Price
S36358	No.20 Sterilised Universal Blades, Large Fitting	PACK*100	£10.95

No.21 Sterilised Universal Blades, Large Fitting VALUE



Universal blades, large fitting - Fitting gap 25mm long

- For Scalpel Handle S37166
- Quality sterilised surgical blades
- Packs of 100
- Single use
- Carbon steel
- Indian

Code	Description	UOM	Price
S36359	No.21 Sterilised Universal Blades, Large Fitting	PACK*100	£10.95



ORDER tracking

No.22 Sterilised Universal Blades, Large Fitting



Universal blades, large fitting - Fitting gap 25mm long

- For Scapel Handle S37166
- Quality sterilised surgical blades
- Packs of 100
- Single use
- Carbon steel
- Indian

Code	Description	UOM	Price
S36360	No.22 Sterilised Universal Blades, Large Fitting	PACK*100	£10.95

No.24 Sterilised Universal Blades, Large Fitting



Universal blades, large fitting - Fitting gap 25mm long

- For Scapel Handle S37166
- Quality sterilised surgical blades
- Packs of 100
- Single use
- Carbon steel
- Indian

Code	Description	UOM	Price
S36361	No.24 Sterilised Universal Blades, Large Fitting	PACK*100	£10.95

Scalpel (Blades, small fitting) Sterilised

Scalpel - Surgical - Sterilised - Universal Small Fitting Blades

- Universal Blades, Small Fitting
- Fitting gap 18mm long
- Quality sterilised surgical blades
- Packs of 100
- Single use
- Carbon steel
- Indian

Caution: Blades are incredibly sharp

Scalpel, Metal Handle (small fitting)



- Takes Universal Blades, Small Fitting
- Stainless steel
- 130mm overall length
- Takes Universal Blades, Small Fitting
- For Blades 10, 11, 12 & 15

Code	Description	UOM	Price
S36481	Scalpel, Metal Handle (small fitting)	EACH	£1.25

Scalpel, Plastic Handle (small fitting)



- Takes Universal Blades, Small Fitting
- Overall length 130mm
- Takes Universal Blades, Small Fitting

• For Blades 10, 11, 12 & 15

Code	Description	UOM	Price
S36316	Scalpel, Plastic Handle (small fitting)	EACH	£1.25

No.10 Sterilised Universal Blades, Small Fitting



Universal blades, small fitting - Fitting gap 18mm long

- For Scapel Handles S36481 & S36316
- Quality sterilised surgical blades
- Packs of 100
- Single use
- Carbon steel
- Indian

Code	Description	UOM	Price
S36354	No.10 Sterilised Universal Blades, Small Fitting	PACK*100	£7.95

No.11 Sterilised Universal Blades, Small Fitting



Universal blades, small fitting - Fitting gap 18mm long

- For Scapel Handles S36481 & S36316
- Quality sterilised surgical blades
- Packs of 100
- Single use
- Carbon steel
- Indian

Code	Description	UOM	Price
S36355	No.11 Sterilised Universal Blades, Small Fitting	PACK*100	£7.95

No.12 Sterilised Universal Blades, Small Fitting



Universal blades, small fitting - Fitting gap 18mm long

- For Scapel Handles S36481 & S36316
- Quality sterilised surgical blades
- Packs of 100
- Single use
- Carbon steel
- Indian

Code	Description	UOM	Price
S36356	No.12 Sterilised Universal Blades, Small Fitting	PACK*100	£7.95

No.15 Sterilised Universal Blades, Small Fitting



Universal blades, small fitting - Fitting gap 18mm long

- For Scapel Handles S36481 & S36316
- Quality sterilised surgical blades
- Packs of 100
- Single use
- Carbon steel
- Indian

Code	Description	UOM	Price
S36357	No.15 Sterilised Universal Blades, Small Fitting	PACK*100	£7.95

Scalpel (Blades, small fitting) Swann Morton

Scalpel - Swann Morton - Universal Blades (small fitting)

- Swann Morton
- Small Fitting Blades
- Fitting gap 18mm long
- Non Sterile
- Carbon Steel
- Blades supplied in packs of 5 pieces

Swan Morton makes the sharpest cutting tools on the planet and are the best to cut casting moulds.

Founded in Sheffield in 1932, Swann-Morton has become a world leader in the manufacture of surgical blades, scalpels and handles. It is a name respected globally for quality, precision, consistency and reliability and recognised for combining traditional blade making skills with the latest technology.

The Swann-Morton Blade Remover allows for safe and easy removal of all sizes of scalpel blade from both No.3 and No.5a handles. Unlike most sharp removal devices it is supplied sterile dispenser making it safe and easy to dispose of those old blades.

The Scalpel Handles range also includes the ergonomically designed Stainless steel and plastic handles, with their smooth tapered shaped body offering precise fingertip control which makes them popular.

- All blades are non sterile, supplied in packs of five and made from carbon steel.
- Made in UK

Scalpel, Acrylic Handle



- Takes Universal Blades, Small Fitting
- Swann Morton Type 5A
- Metal blade mount with easy grip acrylic handle
- For blades 10, 10A, 11 & 12

Code	Description	UOM	Price
S9531	Scalpel, Acrylic Handle	EACH	£9.95

Scalpel, Metal Handle



- Takes Universal Blades, Small Fitting
- Swann Morton Type 3
- Metal blade mount with all metal handle
- For blades 10, 10A, 11 & 12

Code	Description	UOM	Price
S9530	Scalpel, Metal Handle	EACH	£3.75



No.10 SM Blades, Small Fitting

Swann Morton blades, small fitting - Fitting gap 18mm long

For Scapel Handles S9531 & S9530

- Swann Morton
- Non Sterile
- Carbon Steel
- Blades supplied in packs of 5 pieces

Code	Description	UOM	Price
S9532	No.10 SM Blades, Small Fitting	PACK*5	£0.90



No.10A SM Blades, Small Fitting

Swann Morton blades, small fitting - Fitting gap 18mm long

For Scapel Handles S9531 & S9530

- Swann Morton
- Non Sterile
- Carbon Steel
- Blades supplied in packs of 5 pieces

Code	Description	UOM	Price
S9533	No.10A SM Blades, Small Fitting	PACK*5	£0.90



No.11 SM Blades, Small Fitting

Swann Morton blades, small fitting - Fitting gap 18mm long

For Scapel Handles S9531 & S9530

- Swann Morton
- Non Sterile
- Carbon Steel
- Blades supplied in packs of 5 pieces

Code	Description	UOM	Price
S9534	No.11 SM Blades, Small Fitting	PACK*5	£0.90



No.12 SM Blades, Small Fitting

Swann Morton blades, small fitting - Fitting gap 18mm long

For Scapel Handles S9531 & S9530

- Swann Morton
- Non Sterile
- Carbon Steel
- Blades supplied in packs of 5 pieces

Code	Description	UOM	Price
S9535	No.12 SM Blades, Small Fitting	PACK*5	£0.90



Scalpel Blade Removers



Swann Morton

The safest way to remove used scalpel blades. Either the single use disposable blade removers or the multi use box. Just insert blade into the box, push down on tab and pull out the scalpel handle. Blade remains harmlessly in the box which is discarded when full.

Code	Description	UOM	Price
S9536	Blade Remover (single use)	PACK*50	£5.80
B47551	Blade Remover (multi use)	EACH	£1.65

Price breaks available, see website

Scissors



Scissors

S39260

- Broad, curved tips
- Stainless Steel
- 115mm overall length
- 14mm Tip length

S3926

- Fine point tips
- Stainless Steel
- 115mm overall length
- 22mm tip length

Code	Description	UOM	Price
S39260	Broad Tip Scissors	EACH	£1.50
S39261	Fine Tip, Scissors	EACH	£1.50

Scissors (Crown) A&F



A*F Swiss - Crown Scissors

Used for cutting thin precious metal sheet especially gold leaf. Top quality, beautifully finished in nickel plated steel.

- One serrated jaw or non serrated jaws
- Curved or straight tips
- Brilliant for cutting thin precious metal sheet or general use
- Polished finish
- Stainless steel
- 115mm overall length

Code	Description	UOM	Price
S40298	A*F Swiss (Curved Tips) One Serrated Jaw	EACH	£10.50
S40299	A*F Swiss (Curved Tips) Smooth Jaws	EACH	£10.50
S40296	A*F Swiss (Straight Tips) One Serrated Jaw	EACH	£7.50
S40297	A*F Swiss (Straight Tips) Smooth Jaws	EACH	£9.95

Scissors (Crown) Cousins

COUSINSUK



Cousins Swiss Style - Crown Scissors

Used for cutting thin precious metal sheet especially gold leaf. Top quality, beautifully finished in nickel plated steel.

- One serrated jaw or non serrated jaws
- Curved or straight tips
- Brilliant for cutting thin precious metal sheet or general use
- Polished finish
- Stainless steel
- 115mm overall length

Code	Description	UOM	Price
S48604	Cousins Swiss Style (Curved Tips) One Serrated Jaw	EACH	£3.95
S48605	Cousins Swiss Style (Curved Tips) Smooth Jaws	EACH	£3.95
S48606	Cousins Swiss Style (Straight Tips) One Serrated Jaw	EACH	£3.95
S48607	Cousins Swiss Style (Straight Tips) Smooth Jaws	EACH	£3.95

CUTTING & SMOOTHING BROACHES

BROACHES, CUTTING

For the jeweller, silversmith, arts craft, contemporary jeweller, model maker, watch & clock repairer.

Use broaches like a hand file to enlarge and align holes in brass, gold, silver & copper etc. Use cutting broaches after drilling to open up slightly the holes and smoothing broaches to create a burnished inside the hole finish.

Ideal whether you're a clock maker fitting bushes or jewellery making needing a tight fit for precious metal wires for beads, earrings, bracelets, bangles or decorative finishing.

Individuals Ø3.75 to Ø10.49mm



Bergeon 1962 series - Cutting Broaches

- Swiss Made

- Top quality precision ground broaches for accurate work
- Size stated is the maximum cutting diameter
- 5 sided broaches

Code	Description	UOM	Price
B48340	Ø3.75mm Bergeon 1962-26	EACH	£5.50
B48339	Ø4.00mm Bergeon 1962-22	EACH	£5.50
B48338	Ø4.25mm Bergeon 1962-18	EACH	£6.95
B48336	Ø4.75mm Bergeon 1962-12	EACH	£7.95
B48335	Ø5.00mm Bergeon 1962-08	EACH	£8.95
B48333	Ø5.50mm Bergeon 1962-02	EACH	£9.75
B0182	Ø5.97mm Bergeon 1962A	EACH	£10.70
B0184	Ø6.15mm Bergeon 1962C	EACH	£10.70
B0186	Ø6.35mm Bergeon 1962E	EACH	£10.70
B0189	Ø6.76mm Bergeon 1962H	EACH	£11.70
B0190	Ø6.91mm Bergeon 1962I	EACH	£11.70
B0192	Ø7.14mm Bergeon 1962K	EACH	£12.75
B0193	Ø7.37mm Bergeon 1962L	EACH	£12.95
B0195	Ø7.67mm Bergeon 1962N	EACH	£15.50
B0196	Ø8.03mm Bergeon 1962O	EACH	£15.75
B0197	Ø8.20mm Bergeon 1962P	EACH	£17.50
B0198	Ø8.43mm Bergeon 1962Q	EACH	£17.50
B0199	Ø8.61mm Bergeon 1962R	EACH	£17.50
B0200	Ø8.89mm Bergeon 1962S	EACH	£17.50
B0202	Ø9.35mm Bergeon 1962U	EACH	£18.95
B0203	Ø9.58mm Bergeon 1962V	EACH	£18.25
B0207	Ø10.49mm Bergeon 1962Z	EACH	£29.95

Ø0.05 to 0.15mm, A*F Swiss



A*F Swiss

Popular pivot broaches with each tube containing 12 broaches comprising of 4 different sizes and 3 of each size. Ideal for broaching pivot holes and well as hand collets etc.

- Sizes:
- B47545: Ø0.05 - 0.10 - 0.12 - 0.15mm

Code	Description	UOM	Price
B47545	Ø0.05 to Ø0.15mm Pivot Broach Set	PACK*12	£16.95

Ø0.05 to 0.20mm, Bergeon

Bergeon 3008

- Swiss Made
- 1 pack of 12 assorted cutting broaches
- Ø0.05 to 0.20mm
- Pivot cutting broaches



Code	Description	UOM	Price
B0174	Ø0.05 to 0.20mm Pivot Cutting Broaches, Bergeon 3008	EACH	£26.25



Ø0.05 to 0.30mm, Bergeon



- Bergeon 1896G
- Swiss Made
- 1 tube of 12 assorted cutting broaches
- Ø0.05 to 0.30mm
- Pivot cutting broaches

Code	Description	UOM	Price
B0171	Ø0.05 to 0.30mm Cutting Broaches, Bergeon 1896G	EACH	£23.50

Ø0.05 to 2.75mm, Bergeon



- Bergeon 5310
- Swiss Made
- 3 Tubes of 12 assorted cutting broaches

- Includes:
- Bergeon 1896G - Ø0.05 to 0.30mm
 - Bergeon 1896C - Ø0.33 to 1.04mm
 - Bergeon 1896A - Ø1.14 to 2.75mm

Code	Description	UOM	Price
B0208	Ø0.05 to 2.75mm Cutting Broaches, Bergeon 1896A, C & G	EACH	£82.95

Ø0.05 to 2.75mm, Bergeon



- Bergeon 30046
- Swiss Made
- 5 Tubes of 12 assorted cutting broaches

Includes:

- Bergeon 1896G - Ø0.05 to 0.30mm
- Bergeon 1896F - Ø0.20 to 0.80mm
- Bergeon 1896E - Ø0.20 to 1.00mm
- Bergeon 1896C - Ø0.33 to 1.04mm
- Bergeon 1896A - Ø1.14 to 2.75mm

Code	Description	UOM	Price
B0177	Ø0.05 to Ø2.75mm Cutting Broaches, Bergeon 30046	EACH	£118.95

Ø0.20 to 0.80mm, Bergeon



- Bergeon 1896F
- Swiss Made
- 1 Tube of 12 assorted cutting broaches
- Ø0.20 to 0.80mm

Code	Description	UOM	Price
B0170	Ø0.20mm to 0.80mm Cutting Broaches, Bergeon 1896F	EACH	£23.95

Ø0.20 to 1.00mm, Bergeon



- Bergeon 1896E
- Swiss Made
- 1 Tube of 12 assorted cutting broaches
- Ø0.20 to 1.00mm

Code	Description	UOM	Price
B0169	Ø0.20mm to 1.00mm Cutting Broaches, Bergeon 1896E	EACH	£22.85

Ø0.33 to 0.69mm, Bergeon



- Bergeon 4251
- Swiss Made
- 1 pack of 12 assorted cutting broaches
- Ø0.33 to 0.69mm

Code	Description	UOM	Price
B0173	Ø0.33 to 0.69mm Cutting Broaches, Bergeon 4251	EACH	£23.95

Ø0.33 to 1.04mm, Bergeon



- Bergeon 1896C
- Swiss Made
- 1 Tube of 12 assorted cutting broaches
- Ø0.33 to 1.04mm

Code	Description	UOM	Price
B0167	Ø0.33 to 1.04mm Cutting Broaches, Bergeon 1896C	EACH	£19.85

Ø0.45 to 1.40mm, German



- German manufacture
- 1 Pack of 6 assorted cutting broaches with plastic handles
- Ø0.45 to 1.40mm

Code	Description	UOM	Price
B36682	Ø0.45 to 1.40mm Cutting Broach Set	PACK*6	£8.75

Ø0.46 to 1.90mm, Bergeon

- Bergeon 4338
- Swiss Made
- 1 pack of 12 assorted cutting broaches
- Ø0.46 to 1.90mm



Code	Description	UOM	Price
B0175	Ø0.46 to 1.90mm Cutting Broaches, Bergeon 4338	EACH	£29.25

Ø0.60 to 2.00mm, German



- German manufacture
- 1 Pack of 6 assorted cutting broaches with plastic handles
- Ø0.60 to 2.00mm

Code	Description	UOM	Price
B36683	Ø0.60 to 2.00mm Cutting Broach Set	PACK*6	£10.85

Ø0.61 to 1.90mm, Bergeon



with Pin Vice

- Bergeon 4982
- Swiss Made
- Includes Bergeon 1842-18A Pin Vice with 2 chucks
- 1 Tube of 12 assorted cutting broaches with PVC Handles
- Ø0.61 to 1.90mm

Code	Description	UOM	Price
B0180	Ø0.61 to 1.90mm Cutting Broaches with Pin Vice, Bergeon 4982	EACH	£29.95

Ø0.70 to 2.90mm, Bergeon



- Bergeon 30544AP
- Swiss Made
- 1 box of 7 assorted cutting broaches with knurled handles
- Ø0.70 to 2.90mm

Code	Description	UOM	Price
B0176	Ø0.70 to 2.90mm Cutting Broaches, Bergeon 30544A	EACH	£51.95

Ø0.70 to 3.00mm, German



- German manufacture
- 1 Pack of 6 assorted cutting broaches with plastic handles
- Ø0.70 to 3.00mm

Code	Description	UOM	Price
B36684	Ø0.70 to 3.00mm Cutting Broach Set	PACK*6	£10.95

Ø0.80 to 2.30mm, Indian



1 Wallet of 6 assorted cutting broaches with handle

- Ø0.80mm
- Ø1.00mm
- Ø1.30mm
- Ø1.60mm
- Ø2.00mm
- Ø2.80mm

Size stated is the maximum cutting diameter (approx.)

Made in India

Code	Description	UOM	Price
B34933	0.80-2.30mm Cutting Broaches with Handle,	EACH	£5.95

Ø1.14 to 2.75mm, Bergeon



- Bergeon 1896A
- Swiss Made
- 1 Tube of 12 assorted cutting broaches
- Ø1.14 to 2.75mm

Code	Description	UOM	Price
B0165	Ø1.14 to 2.75mm Cutting Broaches, Bergeon 1896A	EACH	£26.50

www. Online Discounts

WORLDWIDE DELIVERY

Ø1.20 to 3.00mm, German



- German manufacture
- 1 Pack of 6 assorted cutting broaches with plastic handles
- Ø1.20 to 3.00mm

Code	Description	UOM	Price
B36685	Ø1.20 to 3.00mm Cutting Broach Set	PACK*6	£13.75

Ø2.20 to 6.00mm, German



- German manufacture
- 1 Pack of 6 assorted cutting broaches with plastic handles
- Ø2.20 to 6.00mm

Code	Description	UOM	Price
B0179	Ø2.20 to 6.00mm Cutting Broaches, German	PACK*6	£37.95

Ø2.40 to 6.20mm, Indian



1 Wallet of 6 assorted cutting broaches with handle.

- Ø2.40mm
- Ø2.70mm
- Ø3.20mm
- Ø4.20mm
- Ø5.00mm
- Ø6.20mm

Size stated is the maximum cutting diameter (approx.)

Made in India

Code	Description	UOM	Price
B34934	Ø2.40-6.20mm Cutting Broaches with Handle	EACH	£12.25



Ø2.69 to 5.97mm, Bergeon



- Bergeon 6013
- Swiss Made
- 1 Tube of 6 assorted cutting broaches
- Ø2.69 to 5.97mm

Code	Description	UOM	Price
B0178	Ø2.69 to 5.97mm Cutting Broaches, Bergeon 6013	EACH	£33.95

BROACHES, SMOOTHING



For the jeweller, silversmith, arts craft, contemporary jeweller, model maker, watch & clock repairer.

Use cutting broaches like a hand file to enlarge and align holes in brass, gold, silver & copper etc. Use cutting broaches after drilling to open up slightly the holes and then smoothing broaches to create a polished burnished inside the hole finish.

Ideal whether you're a clock maker fitting bushes or jewellery making needing a tight fit for precious metal wires for beads, earrings, bracelets, bangles or decorative finishing.

Ø0.05 to 0.30mm, Bergeon



- Bergeon 1896H
- Swiss Made
- 1 Tube of 12 assorted smoothing broaches
- Ø0.05 to 0.30mm

Code	Description	UOM	Price
B0172	Ø0.05 to 0.30mm Smoothing Broaches, Bergeon 1896H	EACH	£23.75

Ø0.05 to 2.75mm, Bergeon



- Bergeon 30075
- Swiss Made
- 3 Tubes of 12 assorted smoothing broaches

Includes:

- Bergeon 1896H: Ø0.05 to 0.30mm
- Bergeon 1896D: Ø0.33 to 1.04mm
- Bergeon 1896B: Ø1.14 to 2.75mm

Code	Description	UOM	Price
B4861	Ø0.05 to 2.75mm Smoothing Broaches, Bergeon 30075	EACH	£79.95

Ø0.33 to 1.04mm, Bergeon



- Bergeon 1896D
- Swiss Made
- 1 Tube of 12 assorted smoothing broaches
- Ø0.33 to 1.04mm

Code	Description	UOM	Price
B0168	Ø0.33 to 1.04mm Smoothing Broaches, Bergeon 1896D	EACH	£19.75

Ø0.40 to 1.40mm, German



- German manufacture
- 1 Pack of 6 assorted smoothing broaches with plastic handles
- Ø0.40 to 1.40mm

Code	Description	UOM	Price
B36686	Ø0.40 to 1.40mm Smoothing Broach Set	PACK*6	£10.95



Ø0.60 to 2.00mm, German



- German manufacture
- 1 Pack of 6 assorted smoothing broaches with plastic handles
- Ø0.60 to 2.00mm

Code	Description	UOM	Price
B36687	Ø0.60 to 2.00mm Smoothing Broach Set	PACK*6	£11.95

Ø0.70 to 2.90mm, Bergeon



- Bergeon 30543A
- Swiss Made
- 1 box of 7 assorted smoothing broaches with knurled handles
- Ø0.70 to 2.90mm

Code	Description	UOM	Price
B0209	Ø0.70 to 2.90mm Smoothing Broaches, Bergeon 30543A	EACH	£51.95

Ø0.70 to 3.00mm, German



- German manufacture
- 1 Pack of 6 assorted smoothing broaches with plastic handles
- Ø0.70 to 3.00mm

Code	Description	UOM	Price
B36688	Ø0.70 to 3.00mm Smoothing Broach Set	PACK*6	£18.50

Ø1.20 to 2.80mm, Bergeon



- Bergeon 1896B
- Swiss Made
- 1 Tube of 12 assorted smoothing broaches
- Ø1.20 to 2.80mm

Code	Description	UOM	Price
B0166	Ø1.20 to 2.80mm, Smoothing Broaches, Bergeon 1896B	EACH	£27.75

Ø1.20 to 3.00mm, German



- German manufacture
- 1 Pack of 6 assorted smoothing broaches
- Ø1.20 to 3.00mm

Code	Description	UOM	Price
B36689	Ø1.20 to 3.00mm Smoothing Broach Set	PACK*6	£12.50

Ø2.20 to 6.00mm, German

- German manufacture
- 1 Pack of 6 assorted smoothing broaches
- Ø2.20 to 6.00mm



Code	Description	UOM	Price
B0210	Ø2.20 to 6.00mm Smoothing Broaches, German	PACK*6	£26.75

CUTTING GLASS

GLASS CUTTER

Glass Cutter, Toyo Japan



The Toyo original supercutter is among the best in the industry.

- A precision-ground carbide cutting wheel
- Cuts glass 2mm to 10mm thick
- Known for its long wheel life, this cutter was built to last
- Makes the cleanest scores in glass cutting possible
- 140 ° degree hone
- Narrow head allowing intricate scores
- Brass handle with oil reservoir within the handle
- An automatic oil dispensing system keeps the wheel lubricated every time you cut
- Automatic oil system, prolonging the life of your cutter
- Use standard 3 in 1 oil, our code O8691
- Supplied with pipette
- Manufactured by Toyo
- Made in Japan

- Dimensions:
- 175mm overall length
 - Ø12mm handle
 - 230g

Code	Description	UOM	Price
D49983	Glass Cutter, Toyo Japan	EACH	£19.95

GLASS CUTTER (CIRCULAR)

Glass Cutting Tool



- Circular Glass Cutter
- Pivot at one end allows you to cut the perfect circle every time
- From Ø50mm to Ø405mm!
- Synthetic diamond tip
- Measurement given on the tool is the diameter of the cut
- Made in India

Please note wear safety goggles while operating your cutting tool.

Code	Description	UOM	Price
C32060	Glass Cutting Tool, Indian	EACH	£9.95



GLASS CUTTING MACHINES

Kronoglass



It manufactures crystals (both flat and convex) with tempered mineral glasses, synthetic sapphire, sapphire, unbreakable material, virtually any shape can now be replaced.

This glass-cutting unit will make a new glass from the old glass, or from a resin pattern that can be quickly prepared by using the bezel as a template. The patterns can be used again and again and can be stored by case number for easy identification.

- The market leader equipment that lets you to grind to form a mineral watch glass according to a resin shape
- The unique glass or a print achieved with the help of the measuring device
- The machine works on a copying basis.... Very precise!
- One of the favourite unit to cut watch glasses in house
- Easy set up
- Offer fast glass cutting services for the trade and your customers
- For acrylic and mineral glass blanks please see the associated items below
- To make convex glasses a convex glass die is required (see dies below)
- Can make glasses up to 60mm wide, up to 2.5mm thick
- 220 to 240 Volt (230 to 110 volt converter please see our code A52044)
- For spare parts breakdown see either PDF link above or the additional images available
- CE marked

Included:

- Main Reducing Diamond Wheel
- Interior Bevel Diamond Wheel
- Exterior Bevel Diamond Wheel
- Bevel Polishing Diamond Wheel

Supplied with:

- 1 bottle K1 resin, for producing templates for glass cutting machine (G0704)
- 1 bottle K2 hardener, to mix with the K1 resin (G0705)
- 1 bottle (gr. 250) of emulsible oil "K3"
- 1 bottle (gr. 50) of lubricating oil "K4"
- 1 corundum stone "K5"
- Glass centring tool
- Glass holder
- 3 hexagonal keys (mm 2-2,5-4)
- 1 fixed key (mm 8-10)

Also available:

- Mineral glass blanks (see from our code MPLS15015007)

Click website "More Information" for full specification.

Code	Description	UOM	Price
G0702	Glass Cutting Machine, Kronoglass	EACH	£2,495.00

G52299	Water Circulation Pump for Kronoglass	EACH	£125.00
G49465	Convex Glass Processing Kit	EACH	£675.00
G7340	Complete Set of 4 Diamond Grinding Wheels	PACK*4	£845.00
G7342	Diagram 1 - Replacement Part 1	EACH	£83.95
G52244	Diagram 1 - Replacement Part 2	EACH	£19.95
G52245	Diagram 1 - Replacement Part 3	EACH	£595.00
G52246	Diagram 1 - Replacement Part 4	EACH	£29.95
G52247	Diagram 1 - Replacement Part 5	EACH	£24.95
G52248	Diagram 1 - Replacement Part 6	EACH	£17.50
G52249	Diagram 1 - Replacement Part 7	EACH	£225.00
G52250	Diagram 1 - Replacement Part 8	EACH	£34.95
G52251	Diagram 1 - Replacement Part 9	EACH	£24.95
G52252	Diagram 1 - Replacement Part 10	EACH	£24.95
G52253	Diagram 1 - Replacement Part 11	EACH	£33.95
G52254	Diagram 1 - Replacement Part 12	EACH	£29.95
G52255	Diagram 1 - Replacement Part 13	EACH	£49.95
G7341	Diagram 1 - Replacement Part 14	EACH	£10.95
G52256	Diagram 2 - Replacement Part 4	EACH	£32.95
G7338	Diagram 2 - Replacement Part 6	EACH	£29.65
G52257	Diagram 2 - Replacement Part 7	EACH	£77.95
G7343	Diagram 2 - Replacement Part 8	EACH	£24.95
G52258	Diagram 2 - Replacement Part 9	EACH	£9.95
G0712	Diagram 2 - Replacement Part 10	EACH	£210.00
G0711	Diagram 2 - Replacement Part 11	EACH	£244.95
G52260	Diagram 2 - Replacement Part 12	EACH	£15.95
G0713	Diagram 2 - Replacement Part 14	EACH	£210.00
G7344	Diagram 2 - Replacement Part 15	EACH	£9.95
G52262	Diagram 2 - Replacement Part 16	EACH	£49.95
G20814	Diagram 2 - Replacement Part 17	EACH	£29.95
G52264	Diagram 2 - Replacement Part 18	EACH	£9.95
G52265	Diagram 2 - Replacement Part 20	EACH	£89.95
G52266	Diagram 2 - Replacement Part 21	EACH	£54.95
G52267	Diagram 2 - Replacement Part 22	EACH	£27.95
G52268	Diagram 2 - Replacement Part 23	EACH	£32.95
G52008	Diagram 2 - Replacement Part 24	EACH	£9.95
G52009	Diagram 2 - Replacement Part 25	EACH	£99.95
G20815	Diagram 2 - Replacement Part 26	EACH	£39.95
G0709	Diagram 2 - Replacement Part 27	EACH	£21.95
G52269	Diagram 2 - Replacement Part 28	EACH	£39.95
G52270	Diagram 2 - Replacement Part 29	EACH	£44.95
G0714	Diagram 2 - Replacement Part 30	EACH	£210.00
G52272	Diagram 3 - Replacement Part 1A	EACH	£64.95
G52273	Diagram 3 - Replacement Part 2A	EACH	£7.95
G20817	Diagram 3 - Replacement Part 3A	EACH	£29.95
G20816	Diagram 3 - Replacement Part 4A	EACH	£39.95
G52274	Diagram 3 - Replacement Part 6A	EACH	£66.95
G52275	Diagram 3 - Replacement Part 7A	EACH	£34.95
G20821	Diagram 3 - Replacement Part 8A	EACH	£9.95
G52005	Diagram 3 - Replacement Part 9	EACH	£32.95
G52006	Diagram 3 - Replacement Part 10	EACH	£33.95
G52007	Diagram 3 - Replacement Part 12	EACH	£9.95
G52278	Diagram 3 - Replacement Part 13	EACH	£14.95
G52279	Diagram 3 - Replacement Part 14	EACH	£17.95
G52280	Diagram 3 - Replacement Part 15	EACH	£299.95
G52281	Diagram 3 - Replacement Part 16	EACH	£29.95
G52282	Diagram 3 - Replacement Part 17	EACH	£29.95
G52283	Diagram 3 - Replacement Part 18	EACH	£44.95
G52284	Diagram 3 - Replacement Part 21	EACH	£64.95
G52285	Diagram 3 - Replacement Part 22	EACH	£12.50
G52286	Diagram 3 - Replacement Part 23	EACH	£43.95
G52287	Diagram 3 - Replacement Part 26	EACH	£44.95
G52288	Diagram 3 - Replacement Part 27	EACH	£31.95
G20820	Diagram 3 - Replacement Part 29	EACH	£3.95
G52289	Diagram 3 - Replacement Part 31	EACH	£33.95
G52290	Diagram 3 - Replacement Part 32	EACH	£27.95
G52291	Diagram 3 - Replacement Part 35	EACH	£149.95
G52292	Diagram 3 - Replacement Part 36	EACH	£24.95
G52293	Diagram 3 - Replacement Part 37	EACH	£34.95
G52294	Diagram 3 - Replacement Part 38	EACH	£14.95
G52295	Diagram 3 - Replacement Part 40	EACH	£14.95
G52296	Diagram 3 - Replacement Part 41	EACH	£59.95
G52297	Diagram 3 - Replacement Part 42	EACH	£44.95
G20819	Diagram 3 - Replacement Part 43	EACH	£9.95
G7337	Diagram 3 - Replacement Part 44	EACH	£20.05

G20818	Diagram 3 - Replacement Part 45	EACH	£9.95
G52298	Diagram 3 - Replacement Part 48	EACH	£14.95

GLASS CUTTING CONSUMABLES

Glass Cutting - K1 Resin

- For Kronoglass
- 1000gms
- For producing templates for glass cutting machine
- Mix with hardener K2 (G0705)



Code	Description	UOM	Price
G0704	K1 Resin, Kronoglass	1KG	£59.95

Glass Cutting - K2 Hardening Liquid

- For Kronoglass
- 500ml
- For producing templates for glass cutting machine
- Mix with resin K1 (G0704)



Code	Description	UOM	Price
G0705	K2 Hardening Liquid, Kronoglass	500ML	£27.95

Glass Cutting - K3 Emulsible Oil

- For Kronoglass
- 1000ml
- For glass cutting lubricant
- Mix tank with ¾ water with 500ml K3



Code	Description	UOM	Price
G0706	K3 Emulsible Oil, Kronoglass	1LT	£44.95

Glass Cutting - K5 Corundum Stone

- For Kronoglass
- For fine hand grinding of glasses etc.



Code	Description	UOM	Price
G0708	Corundum Stone for Kronoglass	EACH	£19.95

CUTTING SAWS (HACK, PIERCING & SCROLL)

HACK SAWS

150mm Hacksaw



A hacksaw is a fine-tooth hand saw with a blade held under tension in a frame and is used for cutting materials such as metal or plastics.

Top tip: Cutting on the pull stroke increases the blade tension and will result in greater control of the cut and longer blade life.

- 6" (150mm)
- Tension held blade

Code	Description	UOM	Price
H6254	Junior Hacksaw	EACH	£1.95
B6256	Junior Hacksaw Blades	PACK*10	£2.95

300mm Hacksaw



- Professional hacksaw
- 300mm (12 inch) blade
- Lightweight yet very rigid frame
- Very accurate cutting
- High leverage tension device
- Replacement blades S45925, 27 & 28
- Made by Roebuck

Code	Description	UOM	Price
S45924	300mm Professional Hacksaw	EACH	£10.95

Adjustable Hacksaw



- Adjustable hacksaw
- Can take 300 or 250mm (12 or 10 inch) blades
- Spare blades can be stored in the tubular handle
- Die cast handle with guarded grip
- Very accurate cutting
- Unique blade tensioning nut
- Replacement blades S45925, 27 & 28
- Made by Roebuck

Code	Description	UOM	Price
S45923	Adjustable Hacksaw	EACH	£9.95

Price breaks available, see website



Hacksaw Blades



- Bi-metal hacksaw blades
- Virtually unbreakable and shatterproof
- 300mm (12 inch)
- 18, 24 or 32 teeth per inch (TPI)
- Made by Roebuck

Code	Description	UOM	Price
S45925	18 TPI, 300mm Hacksaw Blade	EACH	£1.50
S45927	24 TPI, 300mm Hacksaw Blade	EACH	£1.50
S45928	32 TPI, 300mm Hacksaw Blade	EACH	£1.50

SAWS BLADES & FRAMES (FRET & PIERCING)



A piercing saw is a small tool in a fretsaw styled frame that has fine blades intended for cutting metal, traditionally used by jewellers, but has uses in model making and an array of metalworking fields that requires fine detail. Piercing saws are capable of cutting other materials including wax, wood and plastic, although principally they are mainly used on metal. The piercing saw gets its name from the process of making 'blind' cuts or 'piercings' whereby a small hole is first drilled through the work; one end of the saw blade is fitted into the saw frame and the other is threaded through the hole. The open end of the blade is then clamped into the remaining end of the saw frame. When sawing is completed, the saw blade is unclamped from one end of the frame and withdrawn from the work.

Piercing saws have a frame with pinch clamps that will grip the blades; handles are usually wooden like the examples from our range below.

Our ranges of saw frames are available in throat depths that vary from three to twelve inches.

The saws illustrated in our product range, have sliding adjustment to cope with differing blade lengths; this also enables the user to use the remainder of any broken blades. The sliding action of this feature is also used to tension the blade rather than the more normal method (described below) that is applied to fixed frames.

The saw blade is fitted into the thumbscrew clamps with the teeth facing towards the handle. The blades are fragile and are

designed to cut on the pull down stroke so that the blade is held straight by the extra tension caused by the teeth's resistance, guaranteeing no buckling of the blade.

The brown colourisation of the blade is due to its copper plate which inhibits rust and also acts as a minor lubricant when cutting hard steel.

However, the most optimum method of lubrication is to pull the blade from end to end across a block of beeswax, which lubricates the cutting and renders the cutting action quieter and 'sweeter to the feel'.

A*F Swiss "Diamond" Saw Blades



A*F Swiss

Made by electroplating diamond particles on to piano wire, the blade offers the best quality available at competitive prices. A heavy coating of diamond ensures long life and quick cutting.

To make the job easier, we recommend using our cutting lubricant wax (B4181). Blades come individually packaged. Great for cutting glass, ceramics, bone, shell, stones and composite material etc.

- Swiss Made
- Length 135mm
- Grit values 60, 100, 120 & 140
- Diameter of blades in brackets

Code	Description	UOM	Price
S47547	60 (Coarse) Diamond Saw Blade (Ø1.30mm)	EACH	£18.50
S47548	100 (Medium - Coarse) Diamond Saw Blade (Ø1.20mm)	EACH	£18.50
S47549	120 (Medium) Diamond Saw Blade (Ø1.10mm)	EACH	£18.50
S47550	140 (Fine) Diamond Saw Blade (Ø1.00mm)	EACH	£18.50

A*F Swiss "Gold Shark" Saw Blades



A*F Swiss - Superior Quality

These come in a wide variety of types, thicknesses and tooth frequency. They are made from hardened and tempered steel and have blank end portions that are intended as clamping areas. Rounded profile of the back, non cutting edge aids the sawing of curved lines and for really tight curves spiral formed blades are available.

Blades are suitable for sawing gold, platinum, palladium, silver, brass, copper and steel, these are manufactured in Switzerland. Sizes range from '8' which is the coarsest down to 6/0 which is the finest. The teeth are uniformly honed to ensure the most accurate and rapid cut

Choice of Saw blade will depend on the material being sawn, its thickness and nature of the job. For delicate work, and when cutting very thin material you should use a finer blade, but for general purpose cutting, choose a heavier blade as breakage is reduced.

- A*F Swiss Gold Shark Brand
- Round back to facilitate cutting of curves
- Sizes: 6/0 to 8 (Fine to Coarse)
- Fits majority of piercing saw frames
- Packs of 12 blades
- In specially hardened steel
- Length 130mm

Dimensions:

- Cut x (Thickness x Height*) x Teeth per CM

*lower edge to top of teeth

Code	Description	UOM	Price
P1146M	6/0 Cut (0.18 x 0.34mm) 30 Teeth	Bund*12	£2.15
P1147M	5/0 Cut (0.20 x 0.40mm) 27 Teeth	Bund*12	£1.90
P1148M	4/0 Cut (0.22 x 0.46mm) 24 Teeth	Bund*12	£1.75
P1149M	3/0 Cut (0.25 x 0.50mm) 22 Teeth	Bund*12	£1.75
P1150M	2/0 Cut (0.28 x 0.56mm) 21 Teeth	Bund*12	£1.75
P1151M	0 Cut (0.30 x 0.60mm) 20 Teeth	Bund*12	£1.55
P1152M	1 Cut (0.32 x 0.64mm) 18 Teeth	Bund*12	£1.55
P1153M	2 Cut (0.35 x 0.70mm) 17 Teeth	Bund*12	£1.55
P1154M	3 Cut (0.38 x 0.75mm) 16 Teeth	Bund*12	£1.55
P1155M	4 Cut (0.40 x 0.79mm) 15 Teeth	Bund*12	£1.55
P1156M	5 Cut (0.42 x 0.85mm) 13 Teeth	Bund*12	£1.75
P1157M	6 Cut (0.45 x 0.90mm) 12 Teeth	Bund*12	£1.75
P1158M	8 Cut (0.50 x 1.08mm) 11 Teeth	Bund*12	£2.15

Price breaks available, see website

Bergeon "Old Gold" Saw Blades



Bergeon 6651 - Swiss Made

- Bergeon "Old Gold" Range
- For all metals
- Round back to facilitate cutting of curves
- Sizes: 8/0 to 8 (Fine to Coarse)
- Fits majority of piercing saw frames
- Packs of 12 blades
- In specially hardened steel
- Length 130mm

The teeth are uniformly honed to ensure the most accurate and rapid cut

Code	Description	UOM	Price
P47552	8/0 Cut (0.16 x 0.32mm) 38.5 Teeth	Bund*12	£2.75
P1161M	6/0 Cut (0.18 x 0.36mm) 32 Teeth	Bund*12	£2.75
P1162M	5/0 Cut (0.20 x 0.40mm) 28 Teeth	Bund*12	£2.40
P1163M	4/0 Cut (0.22 x 0.44mm) 26.5 Teeth	Bund*12	£2.35
P1164M	3/0 Cut (0.24 x 0.48mm) 23.5 Teeth	Bund*12	£2.20
P1165M	2/0 Cut (0.26 x 0.52mm) 22 Teeth	Bund*12	£2.20
P1166M	0 Cut (0.28 x 0.56mm) 20.5 Teeth	Bund*12	£2.20
P1167M	1 Cut (0.30 x 0.60mm) 19 Teeth	Bund*12	£2.20
P1168M	2 Cut (0.34 x 0.68mm) 17.5 Teeth	Bund*12	£2.20
P1169M	3 Cut (0.36 x 0.72mm) 16 Teeth	Bund*12	£2.20
P1170M	4 Cut (0.38 x 0.76mm) 15 Teeth	Bund*12	£2.20
P1171M	5 Cut (0.40 x 0.80mm) 14 Teeth	Bund*12	£2.20
P1172M	6 Cut (0.44 x 0.84mm) 13.5 Teeth	Bund*12	£2.20
P1173M	8 Cut (0.50 x 1.10mm) 11 Teeth	Bund*12	£2.20

Price breaks available, see website



Cousins Saw Blades



Cousins - German Made

Our made in Germany brand of saw blades are made from hardened and tempered steel and are ideal for sawing near enough anything you would need to use them on in the jewellery and horological industries.

- Ideal for bone, pearl and any other hard or soft metals
- Can be also used in fine veneers in marquetry or for delicate cutting of wood
- Round back to facilitate cutting of curves
- Sizes: 8/0 to 4 (Fine to Coarse)
- Fits majority of piercing saw frames
- Packs of 12 blades
- In specially hardened steel
- Length 130mm
- Made in Germany

Dimensions:

- Cut x (Thickness x Height*) x Teeth per CM

*lower edge to top of teeth

Code	Description	UOM	Price
S35871	8/0 Cut (0.14 x 0.28mm) 40 Teeth	Bund*12	£2.45
S35870	7/0 Cut (0.16 x 0.32mm) 36 Teeth	Bund*12	£1.95
S35869	6/0 Cut (0.18 x 0.36mm) 32 Teeth	Bund*12	£1.65
S35868	5/0 Cut (0.20 x 0.40mm) 28 Teeth	Bund*12	£1.60
S35867	4/0 Cut (0.22 x 0.44mm) 26.5 Teeth	Bund*12	£1.60
S35866	4/0 Cut (0.24 x 0.48mm) 23.5 Teeth	Bund*12	£1.60
S35865	2/0 Cut (0.26 x 0.52mm) 22 Teeth	Bund*12	£1.60
S35864	0 Cut (0.28 x 0.58mm) 20.5 Teeth	Bund*12	£1.60
S35863	1 Cut (0.30 x 0.63mm) 19 Teeth	Bund*12	£1.60
S35862	2 Cut (0.34 x 0.70mm) 17.5 Teeth	Bund*12	£1.60
S35861	3 Cut (0.36 x 0.74mm) 16 Teeth	Bund*12	£1.60
S35860	4 Cut (0.38 x 0.80mm) 15 Teeth	Bund*12	£1.60

Price breaks available, see website

Economy Saw Blade Set

This economy set is ideal as a starter pack, for students or for the occasional work. 2 dozen saw blades, across 6 grits, at a great value price, make this an essential addition to any toolbox

- 1 Gross, 144 blades
- 6 grits: 4/0, 3/0, 2/0, 1/0, 1 & 2
- Ideal for bone, pearl and any other hard or soft metals
- Fits majority of piercing saw frames
- Supplied in plastic wallet
- Length 130mm



Code	Description	UOM	Price
S40300	Saw Blade Set	EACH	£3.95

Vallorbe "Super Pike" Saw Blades



Vallorbe - Swiss Made - Super Pike

Made in Switzerland by world renowned manufacturer of quality Vallorbe, these saw blades have been

developed using an optimized heat treatment process to reach a maximum level of performance

- Ideal for bone, pearl and any other hard or soft metals
- Can be also used in fine veneers in marquetry or for delicate cutting of wood
- Round back to facilitate cutting of curves
- Sizes: 8/0 to 8 (Fine to Coarse)
- Fits majority of piercing saw frames
- Packs of 12 blades
- In specially hardened steel
- Length 130mm
- Proven quality from half a century of experience in manufacturing
- Vallorbe
- Made in Switzerland

Dimensions:

- Cut x (Thickness x Height*) x Teeth per CM

*lower edge to top of teeth

Code	Description	UOM	Price
P49432	8/0 Cut (0.16 x 0.30mm)	Bund*12	£2.25
P49433	7/0 (0.17 x 0.35mm) 35 Teeth	Bund*12	£1.95
P49434	6/0 Cut (0.18 x 0.36mm) 32 Teeth	Bund*12	£1.95
P49435	5/0 Cut (0.20 x 0.40mm) 28 Teeth	Bund*12	£1.66
P49436	4/0 Cut (0.22 x 0.44mm) 26.5 Teeth	Bund*12	£1.60
P49437	3/0 Cut (0.24 x 0.48mm) 23.5 Teeth	Bund*12	£1.35
P49438	2/0 Cut (0.26 x 0.52mm) 22 Teeth	Bund*12	£1.35
P49439	1/0 Cut (0.28 x 0.58mm) 20.5 Teeth	Bund*12	£1.35
P49440	0 Cut (0.30 x 0.63mm) 19 Teeth	Bund*12	£1.35
P49441	2 Cut (0.34 x 0.70mm) 17.5 Teeth	Bund*12	£1.35
P49442	3 Cut (0.36 x 0.74mm) 16 Teeth	Bund*12	£1.75
P49443	4 Cut (0.38 x 0.80mm) 15 Teeth	Bund*12	£1.75
P49444	5 Cut (0.40 x 0.85mm) 14 Teeth	Bund*12	£1.75
P49445	6 Cut (0.44 x 0.94mm) 13.5 Teeth	Bund*12	£1.85
P49446	8 Cut (0.50 x 1.15mm) 11 Teeth	Bund*12	£1.58

Price breaks available, see website

Adjustable Saw Frames

Strong frames forged in the traditional style from high quality, polished steel with either natural wood or black varnished wooden handles. Large thumb screws and serrated clamps grip blades firmly and make replacement easy. Adjustable frames also make use of broken blades.

- Adjustable piecing saw frames
- Traditional saws to cut pieces to shapes of your design
- Wooden, rubber or plastic handles

Dimension: Depth of saw frame

65mm (2 1/2") Depth Saw Frame



- Wooden handle
- Made in India

Code	Description	UOM	Price
S39566	65mm (2 1/2") Depth Saw Frame	EACH	£3.65



76mm (3") Depth Saw Frame



- Wooden handle

Code	Description	UOM	Price
P4798	76mm (3") Depth Saw Frame	EACH	£4.95

76mm (3") Depth Saw Frame - Rubber Handle



- Rubber Handle

Code	Description	UOM	Price
S39567	76mm (3") Depth Saw Frame - Rubber Handle	EACH	£7.50

100mm (4") Depth Saw Frame



- Plastic handle

Code	Description	UOM	Price
P4799	100mm (4") Depth Saw Frame	EACH	£6.95

125mm (5") Depth Saw Frame



- Plastic handle

Code	Description	UOM	Price
P4800	125mm (5") Depth Saw Frame	EACH	£7.65

150mm (6") Depth Saw Frame



- Plastic handle

Code	Description	UOM	Price
P4801	150mm (6") Depth Saw Frame	EACH	£7.85

Fixed Saw Frames, Deep Bow

Finely balanced, strong frames forged in the traditional style from high quality, polished steel with natural wood varnished handles. Large thumb screws and serrated clamps grip blades firmly and make replacement easy.

- Light weight and traditional shape wooden handles
- Deep Bow, ideal to saw the largest items of work

88mm (3 1/2") Depth Saw Frame



Code	Description	UOM	Price
P33902	88mm (3 1/2") Depth Saw Frame	EACH	£3.95

165mm (6 1/2") Depth Saw Frame



Code	Description	UOM	Price
P33903	165mm (6 1/2") Depth Saw Frame	EACH	£4.95

290mm (11 1/2") Depth Saw Frame



Code	Description	UOM	Price
P33904	290mm (11 1/2") Depth Saw Frame	EACH	£5.50

300mm (12") Depth Saw Frame



- Heavy Duty Frame

Code	Description	UOM	Price
S35026	300mm (12") Depth Saw Frame	EACH	£5.95

WORLDWIDE DELIVERY



Online Discounts



ORDER tracking



QUICKSHOP

PRICE PROMISE GUARANTEE



SCROLL SAW

Proxxon Scroll Saw



Proxxon DS230/E

- Cuts waxes, gold, silver, copper, brass and plastics with standard piercing saw blades and wax saw blades. (See full range of sizes of piercing and wax saw blades, sold separately).
- Saw pieces with ease any direction.
- Reduces blade breakage
- The ideal machine for that delicate project: wax cutting, model making and precision work.

- Cuts soft wood (e.g. Balsa) up to 40mm, hard wood up to approx. 10mm, plastic (including PC cards) up to approx. 4mm and non-ferrous metals up to 2mm. Very stable ribbed die-cast aluminium saw frame with 300mm throat. Blade guide with integrated blower. Height adjustable head (3 positions).
- Blade usage is improved as the head may be lowered in two steps, making new blade teeth available. This effectively triples blade life.
- The lowest head position still allows blades, shortened by 60mm, to be used.
- Machined workable of die-cast aluminium, 160 x 160mm. ABS plastic body with side sliding panel for removal of saw dust. VDE approved 220-240V Motor (85W) for prolonged, low noise performance. Quiet, wear-resistant toothed belt drive running in a ball bearing. Electronically controllable stroke rate from approx. 150-2500/min. Adjustable fence and mitre stop with scale.

Code	Description	UOM	Price
S19250	Proxxon Scroll Saw DS230/E	EACH	£114.95

DEMAGNETIZERS, MAGNETS & COMPASSES



Watch Work Shop & Magnetism:

Electronic demagnetizer for watches* and precision tools. Very easy handling.
*Note: Electronic crystal watches must not be demagnetized.

The accuracy of a watch is influenced by magnetism. After servicing and cleaning a mechanic watchwork ought to be demagnetized either when still disassembled or after reassembly.

The balance coils, in particular those in older watchworks can magnetize over a prolonged period of time. Harmonious vibrating of the coil is no longer possible. The watch can no longer work accurately.

Even tools may present a source of magnetism and ought to be demagnetized before use on a watchwork.

Compasses can be used for testing whether or not an object, for example a watch, is magnetised. An object is magnetized when one end of the compass needle is attracted to the item and the other repelled.

Bergeon 3321



- Switch activated
- Demagnetism active zone opening 60x35mm
- Mains operation
- Unit dimensions 135 x 75 x 73mm
- Max. operating period: 1 minute
- 230 or 115 volt switchable
- 650g

Instructions for use:

1. Slowly pass the piece to be demagnetized through the apparatus, and take it out the other side.
2. Repeat the operation several times, always in the same direction.
3. Press the button during the entire operation.

Code	Description	UOM	Price
D0414	Demagnetiser, Bergeon 3321	EACH	£239.95

Cousins Cube

Cousins Magnetizer and Demagnetizer Cube.

Usage: Demagnetizing in watch repair/assembly

- An essential watch tool when changing watch batteries parts etc. Where you cannot risk magnetizing the watch movement thus causing faults.
- Strong plastic construction housing 2 magnets which are in opposite poles
- Economical and compact and has multiple uses.

Usage: Magnetizing Items in Electronics etc.

- Working with fine screws/ components can be awkward trying to pick them up for positioning when applying to your work.

How to use

- insert item or tool into (+) opening and slide back and forth, pull it out then its magnetized
- insert item or tool into (-) opening and slide back and forth, pull it out then it now has become non magnetic

Size:

- Overall size 50mm x 50mm x 28mm
- Chamber size for Demagnetizer and Magnetizer 30mm x 25mm x 15mm
- Weight: 85 grams

Code	Description	UOM	Price
M33831	Magnetizer & Demagnetizer Cube	EACH	£1.95



Elma Antimag

By pressing just one key, Elma Antimag demagnetizes within milliseconds complete watches, disassembled watchwork parts, casings and tools. Small pieces can be put inside a plastic bag which is then placed on the demagnetizing area of the Antimag. This ensures that no pieces can be lost.

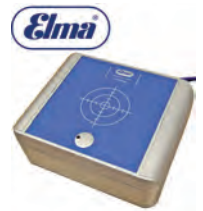

- 160 x 130 x 60mm (width x height x depth)
- LED Display
- 1 kg
- 220 to 240 Volt (230 to 110 volt converter please see our code A52044)
- Requires adapter plug, our code A40932

*Note: Electronic crystal watches must not be demagnetized.

Code	Description	UOM	Price
D32911	Elma Antimag, Electronic Demagnetiser	EACH	£155.00

Etic Swiss

- Etic 340.400
- Swiss Made
- Compact demagnetiser for small parts and tools
- Mains operated with indicator
- Supplied with a 2 pin plug (3 pin UK plug adaptor our code A33069)
- CE marked
- RoHS tested
- 220 to 240 Volt (230 to 110 volt converter please see our code A52044)

Dimensions:

- 110 x 60 x 30mm
- 350g

Code	Description	UOM	Price
D0415	Demagnetiser, Etic 340.400	EACH	£36.25



Greiner Antimag 2

The "Antimag 2" demagnetising unit has an extra-large coil affecting an area of 10cm around the center of the measuring point.



An electronically-generated high-frequency magnetic field works in the fraction of a second on electronically-generated magnetic fields. Ideal for tools and watch movements and small parts.

- Dimensions:
- Length 180mm
 - Width 120
 - Height 60 mm
 - Weight 1.2kg
 - 220 to 240 Volt (230 to 110 volt converter please see our code A52044)

Code	Description	UOM	Price
D12387	Greiner Antimag II Demagnetiser	EACH	£189.95

Greiner Magnomatic

Instruction for use:

- Insert the part to be demagnetized into the opening
- Small watch parts are to be put into a plastic pouch
- Activate the black pushbutton



- Turn the object in two planes at 90 ° angular displacement to remove the rest of magnetism by again activating the push button
- The red light shows you the demagnetizing activation
- See "document" link above for full instruction manual

Technical data:

- 220 to 240 Volt (230 to 110 volt converter please see our code A52044)
- Frequency: 50/60 Hz
- Power consumption : 1 VA
- Weight: 2.5 kg
- Dimensions: 130 x195 x 140

Code	Description	UOM	Price
D12386	Greiner Magnomatic Demagnetiser	EACH	£850.00
D20790	Greiner Magnomatic Demagnetiser On/Off Switch	EACH	£38.75

Greiner Magnetest 2

Measures magnetism of an object and displays the amount by means of red lights. The displayed amount is a relative value, (strong, weak or not at all magnetic).

- Fine adjustment button
- Divide the reading feature for strong magnetic readings
- Ready to use light
- Comes with Adaptor

Dimensions:

- Height 35mm
- Width 95mm
- Depth 160mm

Code	Description	UOM	Price
D12388	Greiner Magnetest II, Measures Magnetism	EACH	£365.00

Horotec Magtest



New, updated & improved!

An electronic device for the detection and elimination of magnetism

- For detecting magnetism as well as demagnetising
- Can be used with watches, watch parts, movements and tools
- LCD screen shows the location and force of magnetism
- Can also be used as a compass
- 220 to 240 Volt (230 to 110 volt converter please see our code A52044)
- CE marked
- Horotec Swiss
- Horotec 19.910

Sensors:

- Tester has 5 sensors, one in the middle of the detection zone, the other 4 forming a 1.5cm square around it
- Will measure the force and location of magnetism
- A dot on the LCD screen shows which sensor is displaying magnetism
- The size of the dot displays the force of magnetism

- If the screen displays magnetism without any magnetic objects present, zero set the tester

On button:

- Single push: Will switch on the detector and demagnetiser. the single push will be followed 3 short beeps (the time in between each beep will determine the battery charge). A fully charged tester will have a gap of 0.5 seconds in between beeps
- 2 seconds continuous push: Activates compass mode. The device can be used as a compass

Off button:

- Single push: Zero sets the tester
- 2 seconds continuous push: Checks battery life by playing the on/off beeps. Can also be checked via the symbol on the LCD screen
- 3 seconds continuous push: Switches off the tester

Code	Description	UOM	Price
T44317	Magtest, Horotec Swiss	EACH	£389.95

Swiss Style with Opening

- Switch activated
- Demagnetism active zone opening 65 x 40mm
- Mains operation
- Unit dimensions 140 x 65 x 70mm
- Max. operating period: 1 minute
- CE Marked
- Made in China



Instructions for use:

Slowly pass the piece to be demagnetized through the apparatus, and take it out the other side. Repeat the operation several times, always in the same direction.

Press the button during the entire operation.

Code	Description	UOM	Price
D38207	Demagnetiser, Hole Opening	EACH	£44.95

Swiss Style with Platform

- Compact demagnetizer for small parts and tools
- Mains operated with power indicator
- 100 x 60 x 30mm
- 220 to 240 Volt (230 to 110 volt converter please see our code A52044)
- CE Marked
- Made in China



Code	Description	UOM	Price
D38206	Demagnetiser, Platform	EACH	£12.95

Witschi Teslascope

Magnetism detection, demagnetisation and control with only one piece of equipment.

The new Teslascope performs the tests for a successful demagnetization and detection of mechanical watches - in a single step.

The Teslascope includes a convenient, free standing support, allowing watches with or without bracelet / strap, movements and steel watch parts of small dimensions to be easily tested.

The evaluation of the measurements takes place by red and green LED's. The magnetization degree is represented strengthen-dependently over several LED's.



The user-friendly operation of this instrument and the easy interpretation of its measurement results will convince you.

Features:

- On /off Switch
- Manual zero set of the magnetic field sensor
- Continuous measurement / examination of the present watch movement
- Demagnetisation of watches, movements or small steel parts
- Acoustical test: built in loudspeaker, which reports the magnetisation degree
- Suitable for open or closed watch movements, with or without bracelet / strap
- 220 to 240 Volt (230 to 110 volt converter please see our code A52044)

Code	Description	UOM	Price
W32158	Witschi Teslascope	EACH	£695.00

Magnets

These magnets are an excellent aid for detecting fallacious materials when precious metal testing. Additionally they are ideal for preliminary tests before the filing and acid testing processes.

Furthermore, owing to metallic inclusions, synthetic diamonds may be attracted or repelled by this magnet as natural diamonds are not magnetic.

Please do not include magnets in your order if you have also ordered the following items as magnets have an adverse effect on them and will cause damage:

- Movements
- Circuits
- Electrical equipment
- Batteries

Horseshoe Magnet 28 x 25mm

- Traditional 'horse shoe' magnet
- A protective steel safety plate is included
- Ideal pocket size weighing only 35g
- Roebuck tools

Size: 22mm x 25mm x 8mm

Code	Description	UOM	Price
M34117	Horseshoe Magnet 28 x 25mm	EACH	£4.50



Magnet Block, 20mm x10mm x 5mm

Length x Width x Depth Magnet for the testing of precious items including gold, silver and platinum. This high strength pocket size magnet will test for base metal in jewellery.

Additionally, they are ideal for a preliminary test before filing and applying acid to the piece.

Code	Description	UOM	Price
M20858	Magnet Block, 20mm x10mm x 5mm	EACH	£2.45



Magent with Handle, Ø45mm x Ø 23mm

- Circular magnet
- Outside diameter Ø45mm
- Inside diameter Ø23mm
- Overall height 65mm
- Handle diameter Ø40mm



Code	Description	UOM	Price
M38657	Magent with Handle, Ø45mm x Ø 23mm	EACH	£4.95

Magnets, Telescopic Pick Up Tool

VALUE



This superb tool is a great addition to a work shop and essential for anyone working with small metal parts.

- Pen style
- Extendible to 80cm
- Collapses to 16.5cm
- Ø12mm Magnet
- Colour may vary

Please do not include magnets in your order if you have also ordered the following items as magnets have an adverse effect on them and will cause damage:

- Movements
- Circuits
- Electrical equipment
- Batteries

Code	Description	UOM	Price
M39689	Magentic Pick Up Tool	EACH	£2.95

Magic Wiper, Bergeon



Magnet - Magic Wiper - Bergeon Swiss

- For recovering small metal pieces or dropped watch parts
- Tearproof & washable
- Consists of 2 double-sided magnetic strips
- Supplied flat
- Folded dimensions: 285 x 82mm
- Bergeon 7871

Code	Description	UOM	Price
M39011	Magic Wiper, Bergeon Swiss	EACH	£11.50

Compass

- Ø40mm
- Black plastic base
- Clear plastic top
- Detects magnetism
- Made in India



Code	Description	UOM	Price
S39280	Compass	EACH	£1.25

Compass, Bergeon

Bergeon 30103 - Swiss Made

- Jewelled model sapphire on hardened steel point, chromium plated brass
- Precision compass
- Engraved 13mm dial
- Compass with stylish black wooden case
- Detects magnetism
- Overall size 40 x 40 x 20mm
- Bergeon Swiss



Code	Description	UOM	Price
C0393	Compass - Bergeon 30103	EACH	£44.75

DENTAL TOOLS

Dental Kit



Dental Kit

- Pack*3
- Can be sterilised
- Stainless steel

Kit contains:

- Inspection mirror, overall length 160mm, mirror diameter Ø22mm
- Bent, pointed spatula, overall length 145mm
- Tweezers, curved serrated tip, overall length 160mm

Code	Description	UOM	Price
D39327	Dental Kit	PACK*3	£2.95

Haemostat Forceps



- Haemostat locking forceps
- Brilliant for holding items hands free
- Lift finger holes away from each other to unlock
- Serrated jaws

- Overall length 135mm

Code	Description	UOM	Price
S39496	Curved Blade Forceps	EACH	£2.95
S39495	Straight Blade Forceps	EACH	£2.95

Inspection Mirror



Inspection Mirror

- Great for viewing hard to see areas of clock movements, jewellery work, etc
- Traditional dentist's inspection mirror
- Overall length 160mm
- Mirror diameter Ø22mm
- Stainless steel, knurled handle

Code	Description	UOM	Price
S39285	Inspection Mirror	EACH	£1.25

Probe Set



- Pack*3
- Can be sterilised
- Stainless steel
- Effective for scribing, polishing or in the dental trade
- Knurled handles
- Overall length 150mm

- Kit contains;
- Straight end probe
 - Right angle probe
 - Hook probe

Code	Description	UOM	Price
P45722	Probe Set	PACK*3	£2.95

DRILLS

BENCH DRILLS

A bench drill is a fixed style of drilling machine that can be mounted on a workbench.

- Unlike a hand-held drill machine; it is far more accurate
- The pillar drill is also known as drill press, pedestal drill or bench pillar drill
- It comprises of a base that supports a column, table, pillar, spindle and a drill head
- Height of the drill table can be adjusted by means of a table lift crank that can be locked in position with a table lock
- A drill press is a valuable tool in any workshop and we offer two models for varying purposes
- Bench mounted models, being compact in design, save space in a smaller shop and can be moved when needed
- The bench models come with optional accessories and attachments giving the

www. Online Discounts

owner greater capacity to handle all sorts of projects

Ø1.00 to 3.20mm, Proxxon TBM



Ø1.00mm to Ø3.20mm Capacity - Proxxon TBM

- German made Proxxon high quality bench drill with a solid 220 x 120mm base/foot of ribbed cast aluminium and featuring an adjustable fence
- The rigid Ø20mm diameter column is hard chromed and 280mm tall giving good working height and a throat depth of 140mm
- The 220-240v motor is an 85W VDE approved unit driving a 3 step pulley via a flat belt providing steady speeds of: 1,800, 4,700 and 8,500 rpm
- Triple ball bearing shaft design gives essentially play free spindle rotation via the included 6 piece collet set.
- Optionally a 3/8" bespoke Jacobs style chuck and key can be supplied (see ref: D9745).
- See also the Proxxon Machine vice to go with this press (see ref: D9746).
- Capacities via 6 collets: 1.00, 1.50, 2.00, 2.40, 3.00 & 3.20mm

Code	Description	UOM	Price
D9743	Ø1.00 to 3.20mm Capacity, Proxxon TBM	EACH	£149.95

Ø1.00 to 10.00mm Proxxon TBH



Ø1.00mm to Ø10.00mm Capacity - Proxxon TBH

- German made Proxxon high quality bench drill press with a cranked and lockable headstock height adjustment on a rigid 45 x 500mm column
- Featuring a ribbed cast base/foot of 20cm sq and a milled workarea with T-slots
- Long life 220-240V permanent magnet motor with belt drive to a 3 step pulley yielding rotational speeds of: 1,800, 2,400 and 4,500rpm. This configuration yields a torque multiplication of as much as 6x at the lowest speed
- The spindle that has a geared rise and fall quill travel of 63mm runs in steel ball bearings for optimum accuracy during precision work

- Chuck offering a capacity of Ø1.00 to 10.00mm
- See also the Proxxon Machine vice to go with this press (see ref: D9746)

Code	Description	UOM	Price
D9744	Bench Drill - Ø1.00 to 10.00mm Capacity, Proxxon TBH	EACH	£295.00

Drill Chuck, Proxxon TBM

Proxxon TBM Drill - Chuck

Specifically made as an optional extra for TBM drill

- Ø0.50 to 6.00mm
- Proxxon TBM drill (D9743)



Code	Description	UOM	Price
D9745	Chuck for Proxxon TBM Drill	EACH	£8.95

ELECTRIC HAND DRILLS

Einhell Electric Drill



Einhell Germany Single Impact Hand drill

This single impact hand drill is exceptional value for money not to mention perfect to use with a flexible drive shaft (Code S33155).

Because of its variable speed control it is perfect to twist wire to make bangles, necklaces, earrings, etc. One simple technique to form this jewellery style is to lock the wires into the keyless chuck and the other hold in a bench vice or a hand vice. If you are using a hand vice get a colleague to hold the other end, set the electronic speed controller to number one, press the control button and the wire will twist. The longer the wire is twisted, the more they intertwine, so continue until the appropriate design has been achieved.

To add other forms to the wire roll them through a rolling mill, planishing press or hammer them with a planishing hammer this will add even more elements to the design of the piece.

Create some fantastic designs with wire twisting, using an array of metals including gold, silver, copper, brass, etc.

Features:

- Keyless chuck holding 1.6mm (1/16) to 12.7mm (1/2")
- Electronic Speed Control from with six settings
- Reverse Facility
- Additional Handle with Depth Gauge
- Casing has a special soft grip finish

Technical specification:

- Power 650w
- Speed 2600rpm
- Drilling Depth (Wood) 25mm

- Drilling Depth (Metal) 10mm
- Drilling Depth (Concrete) 13mm
- 3 pin UK plug
- 230 volt

Weight: 2.5kg

Code	Description	UOM	Price
D33521	Einhell Electric Drill	EACH	£22.95

FLEXIBLE DRILL SHAFT & ATTACHMENTS

Drill Tapered Spindle, Pig Tail



Pig Tails are a great attachment to mount on any DIY house hold drill. Mount on a large selection of mops and abrasives to grind, smooth and polish pieces giving a fresh new look, all supplied from Cousins Material House, please see links below.

We also supply a Flexible Drive Shaft (Code S33155), to attach to the drill, enabling the user to access intricate areas when added flexibility is required.

- Diameter shank: 6mm
- Overall length: 80mm
- Thread Maximum Ø15mm
- Weight: 45g

Code	Description	UOM	Price
S33350	Pig Tail Tapered Spindle	EACH	£3.95

Flexible Drive Shaft with Keyless Chuck



The Faithful Flexible Drive Shaft will fit directly into the chuck of any cordless or electric power drill. The reinforced ends and anti-kink designs prevent wear and helps provide a long working life.

A keyless chuck makes changing bits easy and the plastic hand grip provides a firm hold making the shaft easy to guide when in use.

Using a flexible drive enables you to take your power tool to the most inaccessible places just some of the attachments can be used below. Polishing, grinding, drilling, texturing, smoothing, reducing are just a few of the many tasks the Faithful Flexible Drive Shaft can be used for.

Abrasive attachments can be used with this Flexible Drive Shaft (do not exceed Ø100mm for controlled usage)

- Wheels: Brass, Bristle, Bufflex, Cotton, De-oxidization, Felt, Satin Fibril, Steel, Wool

- Mops: Cotton End, Loose Fold, Dolly, Stitched

Ideals for Use:

- Final finish on embellishments, brass, in clock refurbishment.
- Polishing and restoring alloy wheels, car bumpers, handle parts for automobiles and bikes.
- Repairing and restoring antique furniture fittings.
- Polishing and brightening bathroom and kitchen fittings like brass and steel.
- Get those old pots and pans & cutlery looking new
- Polish brass plaques to new.
- Brighten up old brass, bronze, pewter ornaments, trays, plaques, fire place grills, figurines and statues.
- Restore and make a old steel/brass staircases to look like new.
- Clean up iron garden gates, fences, grills, etc.

If you find the Flexible Drive Shaft too large for some applications view rotary drills for finer work.

Please note:

- Always wear eye protection.
- When fitting the mandrel in the collet, leave 15mm of mandrel from the collet to the mounted bit for ultimate performance.

Features:

- Overall length 1.1mm (44")
- 6mm (1/4") keyless chuck
- Maximum 6000rpm
- Weight: 750g

Code	Description	UOM	Price
S33155	Flexible Drive Shaft with Keyless Chuck	EACH	£19.95

MANUAL HAND DRILLS

Archimedean Drills

A hand drill is a manual tool that converts and amplifies the circular motion of the crank into the circular motion of a drill chuck.

Miniature Archimedean drills are drills which are a small spiral type hand drill which operates by pushing the center piece up and down.

- Spring loaded and non spring loaded
- Extra large available

Archimedean, Regular



- For fine drilling of holes
- Easy to use
- Hold from the top knurled handle and push down the barrel which rotates the drill head
- Capacity Approx Ø0.30 to Ø1.00mm
- Overall length 100mm

Code	Description	UOM	Price
D39352	Archimedean, Regular	EACH	£1.95

WORLDWIDE DELIVERY

OVER 130,000 DIFFERENT ITEMS

Archimedean, Sprung



- For fine drilling of holes
- Easy to use
- Hold from the top knurled handle and push down the barrel which rotates the drill head
- Spring action lifts head back to position for constant action
- Capacity Approx Ø0.30 to
- Overall length 100mm

Code	Description	UOM	Price
D0444	Archimedean, Sprung	EACH	£2.95

Archimedean, Sprung, A*F Swiss



- A*F Swiss
- Good quality for fine work
- Spring loaded, spiral system
- Steel chuck and brass handle
- Chuck closing completely
- Overall length 100mm

Code	Description	UOM	Price
D47302	Archimedean, Sprung, A*F Swiss	EACH	£15.95

Archimedean, Extra Long



- For fine drilling of holes
- Easy to use
- Hold from the top knurled handle and push down the barrel which rotates the drill head
- Capacity Approx Ø0.10 to Ø1.40mm
- Comes with two chucks
- Overall length 190mm

Code	Description	UOM	Price
D34916	Archimedean, Extra Long	EACH	£1.95

Archimedean, Extra Large (Wooden Handle)



- For fine drilling of holes
- Easy to use
- Hold from the top wooden handle and push down the barrel which rotates the drill head
- Capacity Approx Ø2.00 to Ø2.30mm
- Overall length 270mm

Code	Description	UOM	Price
D39355	Archimedean, Extra Large (Wooden Handle)	EACH	£3.95

Online Discounts

www.cousinsuk.com

Bow Drill

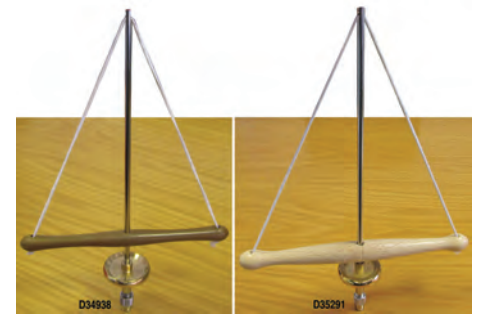

The traditional jewellers bow drill is functioned by moving the wooden handle up and down triggering the drill bit to rotate. Even though this may look complicated it is actually very simple to use with just a little practice and has a good, even drilling action. Jewellery drills, twist drill bits, diamond coated drill bits and rotary burs can all be used with your bow drill

Putting together your Bow Drill:

First, slot the wooden handle over the metal shaft through the middle hole.

Secure a knot in one end of the cord and thread the other end up through one of the end holes in the wooden handle. Make sure the knot is on the underside of the handle.

Thread the cord through the hole in the top of the metal shaft and down through the other side of the wooden handle. Secure a knot to hold it in place under the handle as you have on the opposite side.

How to use your Bow Drill:

The drill can look a bit complex to use but it's truly a very simple procedure which you will soon get to master. If you are drilling sheet metal, it is a good idea to mark the point to be drilled with a center punch as this will give you a good initial point for the drilling and should help avoid the drill bit from gliding across your work.

Place the drill bit over the point to be drilled and twist the shaft whilst gently holding the handle. This will wrap the cord around the shaft and draw up the handle.

Functioning the drill only requires one hand so the other is free to hold your work if required. Place two fingers on the wooden handle either side of the shaft and push down gently. This will begin the momentum needed for the drilling action. Once the handle reaches the bottom it will begin to rise back up the shaft, so allow your hand to raise with it before pushing back down when the handle has returned to the top. This should become a smooth flowing action and the drill will build up speed as you work.

Code	Description	UOM	Price
D34938	Bow Drill, Traditional	EACH	£7.95
D35291	Bow Drill with Wooden Handle	EACH	£9.75

Hand Drills

A hand drill is a manual tool that converts and amplifies the circular motion of the crank into the circular motion of a drill chuck.



- Traditional hand drill
- "Eggbeater" type drill
- Has comfortable wooden handles
- Excellent smooth gear system
- Collet from 0 to 4.5mm
- Made in India
- Very good for twisting wire for obtaining a pattern effect
- Weight 700g

Code	Description	UOM	Price
D20867	Hand Drill with Chuck	EACH	£5.95

ROTARY HAND HELD DRILLS

Rotary Drill & Tool Kit



- Precision pen grip handpiece of low voltage and single speed of 18000rpm.
- Includes transformer, 44 varied multipurpose accessories and organiser box.
- Standard Ø2.35mm handpiece capacity.

Code	Description	UOM	Price
D9740	Rotary Drill & Tool Kit	EACH	£22.95

Rotary Drill & Tool Kit, Variable Speed



- Precision pen grip handpiece of low voltage and variable speeds from 8000 to 18000rpm.
- Includes transformer, coiled power line, 60 assorted multipurpose accessories and organiser box.
- Includes 4 collets, Ø1.00, 2.35, 3.00 & 3.20mm

Code	Description	UOM	Price
D9821	Rotary Drill & Tool Kit, Variable Speed	EACH	£39.95

Rotary Drill & Tool Kit, Variable Speed Plus Flexi Shaft, Handpiece & Stand



Einhell Germany Multi Speed Rotary Tool Kit with 189 Accessories

This Hobby Rotary Kit is exceptional value for money with an array of accessories to cater for all grinding, polishing, drilling and engraving needs.

Included:

- 189 piece accessories kit including felts, sanders, drill bits and stone grinders
- Shelved compartmental storage box and carrying case comprising a tilting shelf
- Flexible drive shaft, 1 metre long
- Table clamp stand
- 135 Watt headpiece is variable speed and reaches speeds of up to 35,000pm
- Soft grip hand piece
- Easy action control speed setting knob integrated with headpiece
- 4 interchangeable collets sizes: Ø0.5, 1.6, 2.4 & 3.2mm
- Please note the accessories included are all shank size 3mm
- Einhell Germany

Cousins Material House supply a full range of replacement bits for this unit, shank size 2.35mm (changing the collet will be required included in kit), take a look at our vast range and find a similar replacement bit with this accessories range.

Dimensions:

- Drill Overall length: 230mm
- Drill Diameter: Ø60mm
- Drill Weight: 600g
- Hanger length: from 25 to 55cm
- Length of flexshaft including handpiece: 110cm
- Handpiece diameter: Ø20mm
- Overall Weight: 2.4 kg

Code	Description	UOM	Price
G33522	Rotary Drill & Tool Kit, Variable Speed Plus Flexi Shaft, Handpiece & Stand	EACH	£44.95



BROWSE & BUY



TRADE SUPPLIER

Burr Lubricant Wax

Ideal for reducing drag and pull with burrs, drills, gravers, saw blades etc.

See Page 702



DRILL BITS

CORE DRILLS

Core Drills, Diamond Coated, A*F Swiss



A*F Swiss

Use core drills to cut holes in ceramics, tile and glass without chipping or cracking. Our diamond coated Swiss made core drills have a Ø3.0mm shank, medium-fine grit and are made of hardened steel on which diamond particles have been electroplated.

- Cut holes in ceramics, tile and glass
- No chipping or cracking
- Swiss made
- Ø3.0mm shank
- Medium-fine grit

Available individually in diameters:

- 1.5 - 2.0 - 2.5 - 3.0 - 5.0 - 6.5 - 9.5 - 10.0 - 11.0mm

Code	Description	UOM	Price
D47369	Ø1.50mm Diamond Core Drill	EACH	£6.75
D47370	Ø2.00mm Diamond Core Drill	EACH	£6.75
D47371	Ø2.50mm Diamond Core Drill	EACH	£7.75
D47372	Ø3.00mm Diamond Core Drill	EACH	£7.75
D47373	Ø5.00mm Diamond Core Drill	EACH	£18.95
D47374	Ø6.50mm Diamond Core Drill	EACH	£18.95
D47375	Ø9.50mm Diamond Core Drill	EACH	£18.95
D47376	Ø10.00mm Diamond Core Drill	EACH	£18.95
D47377	Ø11.00mm Diamond Core Drill	EACH	£18.95

PRICE PROMISE GUARANTEE ✓

OVER 130,000 DIFFERENT ITEMS

Online Discounts

DIAMOND COATED DRILL BITS

Diamond Drill Bits, A*F Swiss



A&F Swiss - High Quality - Diamond Coated Jewellery Drills

Superior quality diamond coated drill bits:

- Diamond particles are electroplated the the steel drill bits (no adhesive used)
- Longer lasting, superior reliability & greater accuracy retention
- Satisfaction guaranteed

Diamond coated drill bits are the ultimate for drilling stones, pearls, glass or ceramics.

- Very popular with jewellers, silversmiths, watch makers/repairers, light engineers, model makers plastic fabricators and for arts and crafts
- Used on a whole range of materials such as gold, silver, platinum, copper, brass, pewter, bronze and aluminium
- Also useful for drilling precious gems such as opals, sapphires & emeralds (please note great care is needed when working with such delicate items)
- Used on micromotors and very popular with quick release rotary hand pieces as changing your drill sizes are fast and easy
- Only a small amount of water needed as lubricant
- Grit 140/170

Sizes (approximate):

- Shank Ø2.35mm or 3/32"
- Length of whole drill: 44.5mm
- Drilling length 12mm
- Set includes: 1.00, 1.30, 1.40, 1.60, 1.80 & 2.10mm

Recommended rotary machines

- Jewellers Kit & No20 "Quick Release" Handpiece: K2220CE
- Foredom High Speed Rotary Micromotor Kit K1070CE
- Marathon (Korea) Micromotor & Handpiece M36961

Code	Description	UOM	Price
D0434	Diamond Coated Drill Set	EACH	£29.75
D22803	Ø0.80mm Diamond Drill	EACH	£5.85
D22804	Ø0.90mm Diamond Drill	EACH	£4.95
D33856	Ø1.00mm Diamond Drill	EACH	£5.95
D33857	Ø1.10mm Diamond Drill	EACH	£5.95
D33858	Ø1.10mm Diamond Drill	EACH	£5.95
D0436	Ø1.30mm Diamond Drill	EACH	£4.95
D0437	Ø1.40mm Diamond Drill	EACH	£4.95
D22806	Ø1.50mm Diamond Drill	EACH	£4.95
D0438	Ø1.60mm Diamond Drill	EACH	£4.95
D22807	Ø1.70mm Diamond Drill	EACH	£4.95
D0439	Ø1.80mm Diamond Drill	EACH	£4.95
D22808	Ø1.90mm Diamond Drill	EACH	£4.95
D0440	Ø2.10mm Diamond Drill	EACH	£5.50
D22810	Ø2.20mm Diamond Drill	EACH	£5.50
D22811	Ø2.30mm Diamond Drill	EACH	£5.50

Price breaks available, see website

HSS DRILL BITS

Professional high speed steel (HSS) drill bits are manufactured from high quality grade tool steel to meet the requirements of today's high standards.

Each bit has a fully ground flute and cutting tip, featuring a 135 degree point angle and split point providing easy non-slip starting and precision drilling. All these great features help you to achieve superior performance in most materials

- Take advantage quantity discount for bulk buyers
- Suitable for use on gold, silver, platinum, copper, brass, aluminium, bronze, pewter, alloy steels, carbon steels, cast iron, cast steels, hardened alloy steels, stainless steels, plastics, wood and many more materials

Please note: ensure work piece is securely clamped when using in rotary tools and always wear suitable protection.

Ø0.20 to Ø6.00mm, Dormer

Dormer Sheffield England

HSS - High Speed Steel

- High quality, Dormer drill bits
- Good self centring capability
- Can be used on a wide range of materials
- Suitable for hand or machine use
- HSS - High Speed Steel



Code	Description	UOM	Price
D35348	Ø0.20mm Twist Drill	EACH	£6.95
D35349	Ø0.30mm Twist Drill	EACH	£5.35
D35350	Ø0.35mm Twist Drill	EACH	£4.75
D35351	Ø0.40mm Twist Drill	EACH	£4.45
D35352	Ø0.45mm Twist Drill	EACH	£4.20
D35353	Ø0.50mm Twist Drill	EACH	£3.50
D35354	Ø0.55mm Twist Drill	EACH	£4.45
D35355	Ø0.60mm Twist Drill	EACH	£3.70
D35356	Ø0.65mm Twist Drill	EACH	£4.15
D35357	Ø0.70mm Twist Drill	EACH	£3.35
D35358	Ø0.75mm Twist Drill	EACH	£3.48
D35359	Ø0.80mm Twist Drill	EACH	£2.95
D35360	Ø0.85mm Twist Drill	EACH	£3.23
D35361	Ø0.90mm Twist Drill	EACH	£3.15
D35363	Ø1.00mm Twist Drill	EACH	£2.50
D49921	Ø1.10mm Twist Drill	EACH	£2.60
D49922	Ø1.20mm Twist Drill	EACH	£2.59
D49923	Ø1.30mm Twist Drill	EACH	£2.50
D49924	Ø1.40mm Twist Drill	EACH	£2.35
D49925	Ø1.50mm Twist Drill	EACH	£2.19
D49926	Ø1.60mm Twist Drill	EACH	£2.19
D49927	Ø1.70mm Twist Drill	EACH	£2.19
D49928	Ø1.80mm Twist Drill	EACH	£2.22
D49929	Ø1.90mm Twist Drill	EACH	£2.22
D49930	Ø2.00mm Twist Drill	EACH	£2.22
D49931	Ø2.10mm Twist Drill	EACH	£2.22
D49932	Ø2.20mm Twist Drill	EACH	£2.22
D49933	Ø2.30mm Twist Drill	EACH	£2.22
D49934	Ø2.40mm Twist Drill	EACH	£2.22
D49935	Ø2.50mm Twist Drill	EACH	£2.22
D49936	Ø2.60mm Twist Drill	EACH	£2.22

D49937	Ø2.70mm Twist Drill	EACH	£2.26
D49938	Ø2.80mm Twist Drill	EACH	£2.26
D49939	Ø2.90mm Twist Drill	EACH	£2.26
D49940	Ø3.00mm Twist Drill	EACH	£2.26
D49941	Ø3.10mm Twist Drill	EACH	£2.26
D49942	Ø3.20mm Twist Drill	EACH	£2.26
D49943	Ø3.30mm Twist Drill	EACH	£2.26
D49944	Ø3.40mm Twist Drill	EACH	£2.45
D49945	Ø3.50mm Twist Drill	EACH	£2.45
D49946	Ø3.60mm Twist Drill	EACH	£2.50
D49947	Ø3.70mm Twist Drill	EACH	£2.32
D49948	Ø3.80mm Twist Drill	EACH	£2.89
D49949	Ø3.90mm Twist Drill	EACH	£2.89
D49950	Ø4.00mm Twist Drill	EACH	£2.89
D49951	Ø4.10mm Twist Drill	EACH	£2.89
D49952	Ø4.20mm Twist Drill	EACH	£2.57
D49953	Ø4.30mm Twist Drill	EACH	£3.23
D49954	Ø4.40mm Twist Drill	EACH	£3.23
D49955	Ø4.50mm Twist Drill	EACH	£3.23
D49956	Ø4.60mm Twist Drill	EACH	£3.23
D49957	Ø4.70mm Twist Drill	EACH	£3.23
D49958	Ø4.80mm Twist Drill	EACH	£3.38
D49959	Ø4.90mm Twist Drill	EACH	£3.38
D49960	Ø5.00mm Twist Drill	EACH	£3.38
D49961	Ø5.10mm Twist Drill	EACH	£3.65
D49962	Ø5.20mm Twist Drill	EACH	£3.75
D49963	Ø5.30mm Twist Drill	EACH	£3.75
D49964	Ø5.40mm Twist Drill	EACH	£3.87
D49965	Ø5.50mm Twist Drill	EACH	£3.95
D49966	Ø5.60mm Twist Drill	EACH	£4.50
D49967	Ø5.70mm Twist Drill	EACH	£4.41
D49968	Ø5.80mm Twist Drill	EACH	£4.40
D49969	Ø5.90mm Twist Drill	EACH	£4.65
D49970	Ø6.00mm Twist Drill	EACH	£4.70

Price breaks available, see website

Ø0.30 to Ø5.00mm, Cousins



- HSS - High Speed Steel
- Metric sizes
- Supplied in packs of 10, 5 or 3
- Made in UK

Smaller diameter drills are suitable for soft materials such as wood, wax & leather etc. For use on metal, please see our Dormer range of drills starting from our code D35348

Code	Description	UOM	Price
D35734	Ø0.30mm Twist Drill	PACK*10	£3.95
D35735	Ø0.35mm Twist Drill	PACK*10	£3.95
D35736	Ø0.40mm Twist Drill	PACK*10	£3.95
D35737	Ø0.45mm Twist Drill	PACK*10	£3.95
D35738	Ø0.50mm Twist Drill	PACK*10	£3.95
D35739	Ø0.55mm Twist Drill	PACK*10	£3.95
D35740	Ø0.60mm Twist Drill	PACK*10	£3.95
D35741	Ø0.65mm Twist Drill	PACK*10	£3.95
D35742	Ø0.70mm Twist Drill	PACK*10	£3.95
D35743	Ø0.75mm Twist Drill	PACK*10	£3.95
D35744	Ø0.80mm Twist Drill	PACK*10	£3.95
D35745	Ø0.85mm Twist Drill	PACK*10	£3.95
D35746	Ø0.90mm Twist Drill	PACK*10	£3.95
D35747	Ø0.95mm Twist Drill	PACK*10	£3.95
D35748	Ø1.00mm Twist Drill	PACK*10	£3.95

D35749	Ø1.10mm Twist Drill	PACK*10	£3.95
D35750	Ø1.20mm Twist Drill	PACK*10	£3.95
D35751	Ø1.30mm Twist Drill	PACK*10	£3.95
D35752	Ø1.40mm Twist Drill	PACK*10	£3.95
D35753	Ø1.50mm Twist Drill	PACK*10	£3.95
D35754	Ø1.60mm Twist Drill	PACK*10	£3.95
D35755	Ø1.70mm Twist Drill	PACK*10	£3.95
D35756	Ø1.80mm Twist Drill	PACK*10	£3.95
D35757	Ø1.90mm Twist Drill	PACK*10	£3.95
D35758	Ø2.00mm Twist Drill	PACK*10	£3.95
D47217	Ø2.10mm Twist Drill	PACK*10	£3.95
D47218	Ø2.20mm Twist Drill	PACK*10	£3.95
D47219	Ø2.30mm Twist Drill	PACK*10	£3.95
D47220	Ø2.40mm Twist Drill	PACK*10	£3.95
D47221	Ø2.50mm Twist Drill	PACK*10	£3.95
D47222	Ø2.60mm Twist Drill	PACK*5	£3.50
D47223	Ø2.70mm Twist Drill	PACK*5	£3.50
D47224	Ø2.80mm Twist Drill	PACK*5	£3.50
D47225	Ø2.90mm Twist Drill	PACK*5	£3.50
D47226	Ø3.00mm Twist Drill	PACK*5	£3.50
D47227	Ø3.10mm Twist Drill	PACK*5	£3.50
D47228	Ø3.20mm Twist Drill	PACK*5	£3.50
D47229	Ø3.30mm Twist Drill	PACK*5	£3.50
D47230	Ø3.40mm Twist Drill	PACK*5	£3.50
D47231	Ø3.50mm Twist Drill	PACK*5	£3.50
D47232	Ø3.60mm Twist Drill	PACK*3	£2.95
D47233	Ø3.70mm Twist Drill	PACK*3	£2.95
D47234	Ø3.80mm Twist Drill	PACK*3	£2.95
D47235	Ø3.90mm Twist Drill	PACK*3	£2.95
D47236	Ø4.00mm Twist Drill	PACK*3	£2.95
D47237	Ø4.10mm Twist Drill	PACK*3	£3.95
D47238	Ø4.20mm Twist Drill	PACK*3	£3.95
D47239	Ø4.30mm Twist Drill	PACK*3	£3.95
D47240	Ø4.40mm Twist Drill	PACK*3	£3.95
D47241	Ø4.50mm Twist Drill	PACK*3	£3.95
D47242	Ø4.60mm Twist Drill	PACK*3	£3.95
D47243	Ø4.70mm Twist Drill	PACK*3	£3.95
D47244	Ø4.80mm Twist Drill	PACK*3	£3.95
D47245	Ø4.90mm Twist Drill	PACK*3	£3.95
D47246	Ø5.00mm Twist Drill	PACK*3	£3.95

Price breaks available, see website

Ø0.30 to Ø6.00mm, Indian

- HSS - High Speed Steel
- Metric sizes
- Supplied in packs of 10
- Made in India

Smaller diameter drills are suitable for soft materials such as wood, wax & leather etc. For use on metal, please see our Dormer range of drills starting from our code D35348



Code	Description	UOM	Price
D2410	Ø0.30mm Twist Drill	PACK*10	£1.95
D2411	Ø0.35mm Twist Drill	PACK*10	£1.95
D2412	Ø0.40mm Twist Drill	PACK*10	£1.95
D2413	Ø0.45mm Twist Drill	PACK*10	£1.95
D2414	Ø0.50mm Twist Drill	PACK*10	£1.95
D2415	Ø0.55mm Twist Drill	PACK*10	£1.95
D2416	Ø0.60mm Twist Drill	PACK*10	£1.95
D2417	Ø0.65mm Twist Drill	PACK*10	£1.95
D2418	Ø0.70mm Twist Drill	PACK*10	£1.95
D2419	Ø0.75mm Twist Drill	PACK*10	£1.95
D2420A	Ø0.80mm Twist Drill	PACK*10	£1.95
D2420B	Ø0.85mm Twist Drill	PACK*10	£1.95
D2421	Ø0.90mm Twist Drill	PACK*10	£1.95
D2422	Ø0.95mm Twist Drill	PACK*10	£1.95
D2423	Ø1.00mm Twist Drill	PACK*10	£1.95
D2424	Ø1.10mm Twist Drill	PACK*10	£2.40
D2426	Ø1.20mm Twist Drill	PACK*10	£2.40

D2425	Ø1.25mm Twist Drill	PACK*10	£2.40
D2427	Ø1.30mm Twist Drill	PACK*10	£2.40
D2428	Ø1.40mm Twist Drill	PACK*10	£2.40
D2429	Ø1.50mm Twist Drill	PACK*10	£2.40
D2430	Ø1.60mm Twist Drill	PACK*10	£2.40
D2431	Ø1.70mm Twist Drill	PACK*10	£2.40
D2432	Ø1.75mm Twist Drill	PACK*10	£2.40
D2433	Ø1.80mm Twist Drill	PACK*10	£2.95
D2434	Ø1.90mm Twist Drill	PACK*10	£2.40
D2435	Ø2.00mm Twist Drill	PACK*10	£2.40
D2436	Ø2.10mm Twist Drill	PACK*10	£2.95
D2437	Ø2.20mm Twist Drill	PACK*10	£2.95
D2438	Ø2.30mm Twist Drill	PACK*10	£2.95
D2439	Ø2.40mm Twist Drill	PACK*10	£2.95
D2440	Ø2.50mm Twist Drill	PACK*10	£2.95
D2441	Ø2.60mm Twist Drill	PACK*10	£2.95
D2442	Ø2.70mm Twist Drill	PACK*10	£2.95
D2443	Ø2.75mm Twist Drill	PACK*10	£2.95
D2444	Ø2.80mm Twist Drill	PACK*10	£2.95
D2445	Ø2.90mm Twist Drill	PACK*10	£2.95
D2446	Ø3.00mm Twist Drill	PACK*10	£2.95
D2447	Ø3.10mm Twist Drill	PACK*10	£3.25
D2448	Ø3.20mm Twist Drill	PACK*10	£3.25
D2449	Ø3.30mm Twist Drill	PACK*10	£3.25
D2450	Ø3.40mm Twist Drill	PACK*10	£3.25
D2451	Ø3.50mm Twist Drill	PACK*10	£3.25
D2452	Ø3.60mm Twist Drill	PACK*10	£3.25
D2453	Ø3.70mm Twist Drill	PACK*10	£3.25
D2454	Ø3.80mm Twist Drill	PACK*10	£3.25
D2455	Ø3.90mm Twist Drill	PACK*10	£3.25
D2456	Ø4.00mm Twist Drill	PACK*10	£3.25
D2459	Ø4.40mm Twist Drill	PACK*10	£3.25
D2457	Ø4.50mm Twist Drill	PACK*10	£3.25
D2460	Ø4.60mm Twist Drill	PACK*10	£3.25
D2458	Ø5.00mm Twist Drill	PACK*10	£3.25
D2461	Ø5.50mm Twist Drill	PACK*10	£3.25
D2462	Ø5.90mm Twist Drill	PACK*10	£3.25
D2463	Ø6.00mm Twist Drill	PACK*10	£3.25

Price breaks available, see website

Ø0.30 to Ø1.60mm Set

VALUE



- Set 20 pieces
- Ø0.30 to Ø1.60mm
- Each drill compartment is marked with size
- Popular Set
- HSS - High Speed Steel

Smaller diameter drills are suitable for soft materials such as wood, wax & leather etc. For use on metal, please see our Dormer range of drills starting from our code D35348

Code	Description	UOM	Price
D0442	Ø0.30 to Ø1.60mm Twist Drill Set	PACK*20	£4.25

Ø1.05 to Ø2.00mm Set

VALUE



- Set 15 pieces
- Ø1.05 to Ø2.00mm
- Each drill compartment is marked with size
- Great value set
- HSS - High Speed Steel

Smaller diameter drills are suitable for soft materials such as wood, wax & leather etc. For use on metal, please see our Dormer range of drills starting from our code D35348

Code	Description	UOM	Price
D39350	Ø1.05 to Ø2.00mm Twist Drill Set	PACK*15	£4.95

Ø1.00 to Ø6.00mm, Dormer Set

DORMER



- High quality, Dormer drill bits
- 51 pieces, from Ø1.00 to Ø6.00mm
- Good self centring capability
- Can be used on a wide range of materials
- Suitable for hand or machine use
- HSS - High Speed Steel
- Comes in a safe, easy access box

Code	Description	UOM	Price
D35492	Dormer HSS Drill Set Ø1.00 to Ø6.00mm	PACK*51	£130.00

Online Discounts

Pin Vices & Chuck Adaptors

VALUE



See Page 1065

Ø1.50 to Ø6.50mm, Faithful Set



- Set 13 pieces
- Ø1.50 to 6.50mm
- Each drill compartment is marked with size
- Popular Set

Faithfull professional high speed steel (HSS) drill bits are manufactured from high quality grade tool steel, to meet the requirements today's high standards.

Each bit has a fully ground flute and cutting tip, featuring a 135 degree point angle and split point providing easy non-slip starting and precision drilling. All these great features help you to achieve superior performance in most materials

- Storage box included with drill size marking
- Available in loose format for bulk users.
- Suitable for use on gold silver platinum copper brass aluminium bronze pewter alloy steels carbon steels cast iron cast steels hardened alloy steels stainless steels plastics wood and many more materials.

Code	Description	UOM	Price
D33156	Ø1.50 to Ø6.50mm Twist Drill Set	PACK*13	£11.85

Ø1.50 to Ø6.50mm Set

VALUE



- Set 13 pieces
- Ø1.50 to Ø6.50mm
- Each drill compartment is marked with size
- Great value set
- HSS - High Speed Steel

Code	Description	UOM	Price
D39351	Ø1.50 to Ø6.50mm Twist Drill Set	PACK*13	£4.95

JEWELLERY DRILL BITS



Jewellery drill bits are an industry standard size Ø2.35mm shank. This allows fast, smooth and seamless transition between sizes of drill, burrs and even silicones or mini mops, whilst using your pendant or micromotor. They are the most popular drill bits in the jewellery, horology and associated industries for this very reason. We have a large range of sizes available below.

- Shank body size, Ø2.35mm or 3/32"
- Are very popular for jewellers, silversmiths, watch makers/repairers, light engineers, model makers plastic fabricators and for arts and crafts
- Can be used on a whole range of materials such as gold, silver, platinum, copper, brass, pewter, bronze and aluminium
- Used with micro motors and quick release rotary hand pieces
- Shank drills are very popular for quick release headpieces as changing your drill sizes is fast and easy

Recommended rotary machines

- Jewellers Kit & No20 "Quick Release" Handpiece: K2220CE
- Freedom High Speed Rotary Micromotor Kit K1070CE
- Saeshin (Korea) Micromotor & Handpiece M9768

Drill Lubricant

See
Page 702



Jewellery Drills, German



- Made in Germany jewellery drills
- Shank body size, Ø2.35mm or 3/32"

- Size:
- Length of whole drill: 45mm
 - Drilling length, 12mm

Code	Description	UOM	Price
D35717	Ø0.50mm Jewellery Drill	EACH	£0.95
D35718	Ø0.60mm Jewellery Drill	EACH	£0.95
D35719	Ø0.70mm Jewellery Drill	EACH	£0.95
D35720	Ø0.80mm Jewellery Drill	EACH	£0.95
D35721	Ø0.90mm Jewellery Drill	EACH	£0.95
D35722	Ø1.00mm Jewellery Drill	EACH	£0.95
D35723	Ø1.20mm Jewellery Drill	EACH	£0.95
D35724	Ø1.30mm Jewellery Drill	EACH	£0.95
D35725	Ø1.40mm Jewellery Drill	EACH	£0.95
D35726	Ø1.50mm Jewellery Drill	EACH	£0.95
D35727	Ø1.60mm Jewellery Drill	EACH	£0.95
D35728	Ø1.70mm Jewellery Drill	EACH	£0.95
D35729	Ø1.80mm Jewellery Drill	EACH	£0.95
D35732	Ø2.00mm Jewellery Drill	EACH	£0.95

Jewellery Drills, A*F Swiss



A World Favourite

- Swiss jewellery drills
- Shank body size, Ø2.35mm or 3/32"
- Alloy steel

- Size:
- Length of whole drill: 45mm

- Drilling length, 12mm

Equivalent:

- Busch 203
- Maillefer 58PM

Code	Description	UOM	Price
D2464	Ø0.50mm Jewellery Drill	EACH	£2.95
D2465	Ø0.60mm Jewellery Drill	EACH	£2.95
D2466	Ø0.70mm Jewellery Drill	EACH	£2.95
D2467	Ø0.80mm Jewellery Drill	EACH	£2.95
D2468	Ø0.90mm Jewellery Drill	EACH	£2.95
D2469	Ø1.00mm Jewellery Drill	EACH	£2.95
D2470	Ø1.10mm Jewellery Drill	EACH	£3.25
D2471	Ø1.20mm Jewellery Drill	EACH	£3.25
D2472	Ø1.30mm Jewellery Drill	EACH	£3.25
D2473	Ø1.40mm Jewellery Drill	EACH	£3.25
D2474	Ø1.50mm Jewellery Drill	EACH	£3.25
D2475	Ø1.60mm Jewellery Drill	EACH	£3.25
D32405	Ø1.70mm Jewellery Drill	EACH	£3.25
D2476	Ø1.80mm Jewellery Drill	EACH	£3.25
D32406	Ø1.90mm Jewellery Drill	EACH	£3.25
D32407	Ø2.00mm Jewellery Drill	EACH	£3.25
D2477	Ø2.10mm Jewellery Drill	EACH	£3.25
D32408	Ø2.20mm Jewellery Drill	EACH	£3.25
D32409	Ø2.30mm Jewellery Drill	EACH	£3.25

Price breaks available, see website

PEARL DRILL BITS



Something's to know about Pearls...

The shape of a pearl is divided into three categories: spherical, symmetrical, and baroque.

The rarest and most valuable is the spherical or round pearl. These are judged on their degree of "sphericity" or roundness. While fine pearls that are perfectly round are extremely rare, the closer a pearl comes to being perfectly round, the more expensive it will be. Pearls with shapes such as teardrop or pear-shape are symmetrical pearls, and are judged on proportioning, outline, and good symmetry; that is, whether they have a nice, pleasing, and well-balanced shape.

Any strand of pearls should be well matched for shape, and when worn give the appearance of uniformity. Terms such as semi-round and semi-baroque are also used.

These are terms applied to pearls that are "out of round" but not so much that their irregular shape is interesting, or distinctive. These cost much less than other shapes. Symmetrical pearls are less expensive than round pearls-although there are some exceptions-but much more expensive than baroque pearls, which are irregularly shaped pearls.

To see more information about pearls we

supply a highly informative book called *The book of Pearls* by Kunz and Stevenson (CODE C9273)

- Pearl Drills with a centre point and two side's cutting edges are the most popular drills to set and drill pearls and is ideal for setting flat backed pearls.
- Using conventional steel burrs can be problematic when drilling flat backed pearls, making dedicated pearl drills easily and essential to do the most complex job.
- Once you have marked the setting location for the pearl(s) touch or push the centre point of the burr on to the setting to be drilled and commence burring clockwise and the drill will remain in its location whilst completing the perfect hole. This virtually eradicates any possibility of the drill moving/running away from the job. The two side cutting edges provides a precision horizontal cutting edge thus opening out the mount evenly.

Cousins Material House supplies a whole range of pearl drills and accessories which cater for all pearl setting, stringing, drilling, storage, etc.

Set your various shapes and sizes of pearls with our array of steel burr range.

Pearl Drills, A*F Swiss (Triangular)

A*F Swiss

These triangular drills, designed specially for pearl drilling are the result of many years of research and experience. In high speed steel (HSS).

- Specially designed
- Triangular
- High Speed Steel (HSS)
- Double ended
- Length 50mm Approx.

Sizes: Ø0.60, 0.70, 0.80, 0.90, 1.00, 1.10, 1.20, 1.40mm

Code	Description	UOM	Price
D47281	Ø0.60mm Triangular Pearl Drill	EACH	£5.25
D47282	Ø0.70mm Triangular Pearl Drill	EACH	£5.25
D47283	Ø0.80mm Triangular Pearl Drill	EACH	£5.25
D47284	Ø0.90mm Triangular Pearl Drill	EACH	£5.25
D47285	Ø1.00mm Triangular Pearl Drill	EACH	£5.25
D47286	Ø1.10mm Triangular Pearl Drill	EACH	£5.25
D47287	Ø1.20mm Triangular Pearl Drill	EACH	£5.25
D47288	Ø1.40mm Triangular Pearl Drill	EACH	£5.25

Pearl Drills, A*F Swiss (Shank Ø3mm)



A*F Swiss

For piercing and to drill setting holes for pearls and other round and half round stones. Specially designed to prevent the chipping of the nacre. Shank diameter Ø3.00mm.

Drill Set contains: Ø1.05, 1.20, 1.25, 1.45, 1.65, 1.85, 2.05, 2.25, 2.40, 2.65, 2.85, 3.00mm

- Popular sizes available individually
- Shank size Ø3.00mm

Code	Description	UOM	Price
D47289	Pearl Drill Set, A*F Swiss	PACK*12	£74.95
D47290	Ø1.05mm Pearl Drill	EACH	£9.75
D47291	Ø1.20mm Pearl Drill	EACH	£9.75
D47292	Ø1.25mm Pearl Drill	EACH	£9.75
D47293	Ø1.45mm Pearl Drill	EACH	£9.75
D47294	Ø1.65mm Pearl Drill	EACH	£9.75
D47295	Ø1.85mm Pearl Drill	EACH	£9.75
D47296	Ø2.05mm Pearl Drill	EACH	£9.75
D47297	Ø2.25mm Pearl Drill	EACH	£9.75
D47298	Ø2.40mm Pearl Drill	EACH	£9.75
D47299	Ø2.65mm Pearl Drill	EACH	£9.75
D47300	Ø2.85mm Pearl Drill	EACH	£9.75
D47301	Ø3.00mm Pearl Drill	EACH	£9.75

Pearl Drills, A*F Swiss (Tungsten)

A*F Swiss

Special drills in "Tool Steel" or "Tungsten Carbide" that have a unique cutting face that scribes the nacre of the pearls surface to avoid chipping.

- Shank Ø2.35mm

Code	Description	UOM	Price
D47314	Ø0.90mm Tungsten Carbide Pearl Drill	EACH	£8.95
D47315	Ø1.00mm Tungsten Carbide Pearl Drill	EACH	£8.95
D47312	Ø2.10mm Tool Steel Pearl Drill	EACH	£6.50
D47313	Ø2.30mm Tool Steel Pearl Drill	EACH	£6.50

Pearl Drills, Busch 417

Busch 417

Specially designed to prevent the chipping of the nacre when drilling or enlarging existing holes

- Shank Ø2.35mm
- Sizes: Ø0.90, 1.00, 1.20, 1.40mm

Code	Description	UOM	Price
B417009	Ø0.90mm Busch Pearl Drill	EACH	£4.15
B417010	Ø1.00mm Busch Pearl Drill	EACH	£4.15
B417012	Ø1.20mm Busch Pearl Drill	EACH	£4.15
B417014	Ø1.40mm Busch Pearl Drill	EACH	£4.15

Price breaks available, see website



Online Discounts

TUNGSTEN CARBIDE DRILL BITS

Tungsten Jewellery Drills are a world favourite. Finest quality in 100% hardened steel for reliability, long life accuracy and satisfaction guaranteed

- Sizes Ø0.50, 0.60, 0.70, 0.80, 0.90, 1.00, 1.10, 1.20, 1.30 and 1.40mm (also available in single pieces see code D0441a to D4333)
- shanked body size Ø2.35mm or 3/32"
- are very popular for jewellers, silversmiths, watch makers/repairers, light engineers, model makers plastic fabricators and for arts and crafts
- can be used on a whole range of materials such as gold, silver, platinum, copper, brass, pewter, bronze and aluminium
- used on micro motors, and quick release rotary hand pieces
- shanked drill are very popular for quick release headpieces as changing your drill sizes are fast and easy
- ideal for drilling tough materials such as glass, ceramic, bone, jade & mother of pearl.

Size :
Length of whole drill 45mm
Drilling length 12mm

Tungsten Carbide Drills, A*F Swiss



A*F Swiss - Tungsten Jewellery Drills are a world favourite.

Finest quality, Swiss made for reliability, long life accuracy and satisfaction guaranteed. Very popular with jewellers, silversmiths, watch makers/repairers, light engineers, model makers plastic fabricators and for arts and crafts.

100% hard metal for drilling tough materials including glass, ceramic, bone, jade, mother-of-pearl as well as various metals. Ideal for use with micro motors and are very popular for quick release headpieces as changing your drill sizes are fast and easy.

- Sizes Ø0.50, 0.60, 0.70, 0.80, 0.90, 1.00, 1.10, 1.20, 1.30 and 1.40mm
- Set contains all sizes from Ø0.50mm to Ø1.40mm
- Length of whole drill 45mm
- Drilling length 12mm
- Shank body size Ø2.35mm or 3/32"

Equivalent:
• Busch 203HSS
• Maillefer 58MD

Code	Description	UOM	Price
D0441A	Ø0.50mm Tungsten Drill	EACH	£6.85
D0441B	Ø0.60mm Tungsten Drill	EACH	£6.85

D0441C	Ø0.70mm Tungsten Drill	EACH	£6.85
D4325	Ø0.80mm Tungsten Drill	EACH	£6.85
D4327	Ø0.90mm Tungsten Drill	EACH	£6.85
D4329	Ø1.00mm Tungsten Drill	EACH	£6.85
D4331	Ø1.10mm Tungsten Drill	EACH	£6.85
D4333	Ø1.20mm Tungsten Drill	EACH	£6.85
D47270	Ø1.30mm Tungsten Drill	EACH	£6.85
D47271	Ø1.40mm Tungsten Drill	EACH	£6.85
D47272	Ø1.50mm Tungsten Drill	EACH	£6.85
D47273	Ø1.60mm Tungsten Drill	EACH	£6.85
D47274	Ø1.70mm Tungsten Drill	EACH	£6.85
D47275	Ø1.80mm Tungsten Drill	EACH	£6.85
D47276	Ø1.90mm Tungsten Drill	EACH	£6.85
D47277	Ø2.00mm Tungsten Drill	EACH	£6.85
D47278	Ø2.10mm Tungsten Drill	EACH	£6.85
D47279	Ø2.20mm Tungsten Drill	EACH	£6.85
D47280	Ø2.30mm Tungsten Drill	EACH	£6.85

Price breaks available, see website

Tungsten Carbide Drills, Horotec Swiss

Horotec Swiss - Tungsten Jewellery Drills are a world favourite.

Finest quality, Swiss made for reliability, long life accuracy and satisfaction guaranteed. Very popular with jewellers, silversmiths, watch makers/repairers, light engineers, model makers plastic fabricators and for arts and crafts.



100% hard metal for drilling tough materials including glass, ceramic, bone, jade, mother-of-pearl as well as various metals. Ideal for use with micro motors and are very popular for quick release headpieces as changing your drill sizes are fast and easy.

- From Ø0.50 to Ø2.30mm
- Set contains all sizes from Ø0.50mm to Ø1.40mm
- Length of whole drill 45mm
- Drilling length 12mm
- Shank body size Ø2.35mm or 3/32"
- Horotec 22.412

Equivalent:
• Busch 203HSS
• Maillefer 58MD

Code	Description	UOM	Price
D52815	Tungsten Carbide Drill Set	PACK*10	£59.95
D52816	Ø0.50mm Tungsten Drill	EACH	£6.75
D52817	Ø0.60mm Tungsten Drill	EACH	£6.75
D52818	Ø0.70mm Tungsten Drill	EACH	£6.75
D52819	Ø0.80mm Tungsten Drill	EACH	£6.75
D52820	Ø0.90mm Tungsten Drill	EACH	£6.75
D52821	Ø1.00mm Tungsten Drill	EACH	£6.75
D52822	Ø1.00mm Tungsten Drill	EACH	£6.75
D52823	Ø1.20mm Tungsten Drill	EACH	£6.75
D52824	Ø1.30mm Tungsten Drill	EACH	£6.75
D52825	Ø1.40mm Tungsten Drill	EACH	£6.75
D52826	Ø1.50mm Tungsten Drill	EACH	£6.75
D52827	Ø1.60mm Tungsten Drill	EACH	£6.75
D52828	Ø1.70mm Tungsten Drill	EACH	£6.75
D52829	Ø1.80mm Tungsten Drill	EACH	£6.75
D52830	Ø1.90mm Tungsten Drill	EACH	£6.75
D52831	Ø2.00mm Tungsten Drill	EACH	£8.50
D52832	Ø2.10mm Tungsten Drill	EACH	£8.50
D52833	Ø2.20mm Tungsten Drill	EACH	£8.50
D52834	Ø2.30mm Tungsten Drill	EACH	£8.50

Price breaks available, see website



DRYERS & HEATING PLATES

Range of different drying units for the jewellery manufacturer/watchmaker-repairer.

Hot & cold air

- New from Elma, the Elmadry TD range
- Hot & cold air functionality
- The ultimate in efficiency and safety standards

Hot air

- Fast & effective Elma machine, hot drying your clock and watch parts
- Compact design one of the most popular units used in today's workshops

Micro Dryer

- Ideal for drying metal components, including jewellery
- Removes water without marking the surface of soft metals
- Use Maizorb as an excellent media that is non-toxic (code D8127)
- Very low running costs

Heating plate

- Electric warming plate for warming watch cases to test the formation of condensation in the watch
- For use in conjunction with our Roxer Nator range (see code W12350)
- Tip: with a change to higher temperatures, residual moisture in the watch will manifest itself as mist in the watch case. It is therefore recommended to always lay water-resistant watches on a heating plate before finally closing the case to drive off this humidity

Hot & Cold Air Dryer, Elma

New from Elma - Hot & Cold Air Dryers - Elmadry TD Range

- Hot & cold air dryer in one
- The ultimate in efficiency and safety standards
- Automatic cut out when maximum temperature is reached
- No need to remove the parts from the cleaning basket
- Simple, fast and safe operation

Specifications:

- Maximum drying temperature 70 °C
- Cooling temperature at room temperature
- Ventilated lid included
- 220 to 240 Volt (230 to 110 volt converter please see our code A52044)
- Grey colour
- See website "more info" for individual specifications

Features:

- Ultrasonic basket can be used in the dryer
- Quick & easy to operate (rocker switch with hot air, cold air and off positions)
- Allows parts to be dried and then cooled quickly
- Lid (included) with ventilation slots ensures effective air flow with moist air escaping the drying chamber
- The lid also reduces the energy consumption, making this more efficient than a standard dryer

- Automatic safety switch off when maximum temperature is reached
- Dust filter prevents dust in the room from contaminating the parts
- Stainless steel construction, protected against dripping water
- Perforated silicone protection mats available separately. They are placed in the base of the dryer to prevent delicate items from being scratched & to stop the item from moving
- Made in Germany, made by Elma

Elma's Principal UK Distributor

TD 30 Dryer



- 240 x 140 x 100mm (tank internal dimensions)
- 264 x 176 x 219 (Overall dryer dimensions)
- 70 °C maximum temperature
- Cooling at room temperature
- 160 meters cubed per hour (air output)
- 15 minutes heating time
- Suitable for S30H basket (U9796)
- 3.6Kg
- Elma 108 2175

Code	Description	UOM	Price
D47676	TD 30 Dryer	EACH	£299.95

TD 120 Dryer



- 300 x 240 x 197mm (tank internal dimensions)
- 342 x 285 x 322 (Overall dryer dimensions)
- 70 °C maximum temperature
- Cooling at room temperature
- 160 meters cubed per hour (air output)
- 15 minutes heating time
- Suitable for multiple baskets
- 6.1Kg

• Elma 107 8542

Code	Description	UOM	Price
D47677	TD 120 Dryer	EACH	£450.00

TD 300 Dryer



- 504 x 300 x 175mm (tank internal dimensions)
- 544 x 347 x 322 (Overall dryer dimensions)
- 70 °C maximum temperature
- Cooling at room temperature
- 320 meters cubed per hour (air output)
- 15 minutes heating time
- Suitable for multiple baskets
- 10.2Kg
- Elma 107 85475

Code	Description	UOM	Price
D47678	TD 300 Dryer	EACH	£799.95

Silicone Mat for TD30

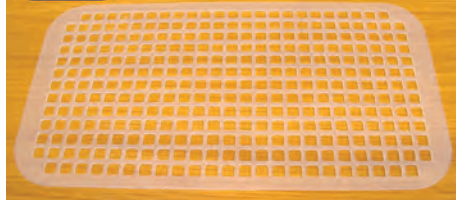

- Perforated silicone mat for TD 30 dryer
- Placed in the base of the dryer to prevent delicate items from being scratched & to stop the item from moving
- Elma 108 2379

Code	Description	UOM	Price
D47679	Silicone Mat for TD30	EACH	£15.85

Silicone Mat for TD120 & TD300

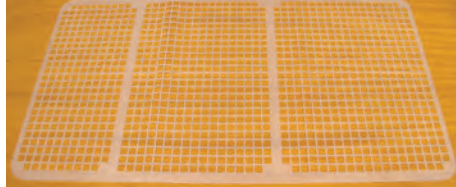

- Perforated silicone mat for TD120 & TD300 dryers
- Placed in the base of the dryer to prevent delicate items from being scratched & to stop the item from moving
- Elma 108 2378

Code	Description	UOM	Price
D47680	Silicone Mat for TD120 & TD300	EACH	£33.95

Microdryer for Jewellery



- This electronically heated drying chamber gives perfect results every time
- Fully enclosed and dust proof
- Immerse jewellery objects into drying media for stain free results
- Thermostatically controlled heater
- 2 kilos of drying media included
- Drying Media: Item D8127
- 220 to 240 Volt (230 to 110 volt converter please see our code A52044)
- Made in Great Britain

Code	Description	UOM	Price
D4901	Dryer - Microdryer for Jewellery	EACH	£163.00

Heating Plate, Bergeon



Watchmakers Electric Heater with Adjustable Temperature for Escapements.

- Adjustable temperature range up to approx 160 °c
- Bergeon 30460
- Smooth Aluminium Working Surface
- Plastic Insulating Frame
- Mains Operated
- Requires adapter, our code A40932
- 220 to 240 Volt (230 to 110 volt converter please see our code A52044)

Can be used for:

- Adjusting pallet stones
- Preparing gaskets for the fitting of mineral glasses
- For drying or warming of projects and softening purposes etc.

Code	Description	UOM	Price
H2816	Heating Plate, Bergeon 30460	EACH	£345.00

Drying Media

See Page 1256



ESSENCE JARS & GEMSTONE WASHING CUPS

Essence jars are a valuable storage container for watch fluids that are prone to evaporating.

- Various sizes and styles available to suit you and your workshop.
- Essence jars are regarded as being essential for the watchmaker/repairer as fluids are maintained and not wasted.
- All our ranges consist of precise grounded glass lids and lips, giving you a perfect seal.

Also, diamond & gemstone washing cups are the perfect way to clean your precious stones in alcohol or any cleaning solution without the fear of losing them.

Essence Jars



- Ø80mm
- Height 40mm
- Cover with glass knob
- Value item
- Lid or jar may need grinding to ensure perfect seal

Code	Description	UOM	Price
A42916	Ø80mm Essence Jar	EACH	£4.25

Essence Jars, AF Swiss



- A*F Swiss
- Ø75mm
- Height 50mm

- Cover with knob
- Lid or jar may need grinding/re-positioning to ensure perfect seal

Code	Description	UOM	Price
E31402	Ø75mm Essence Jar, A*F Swiss	EACH	£23.95

Essence Jars, Bergeon Swiss



- Bergeon 5445
- Cover with glass knob
- Perfectly ground lid and jar ensuring near zero evaporation
- Multiple sizes available

Dimensions:

- Diameter Ø x Height

Code	Description	UOM	Price
E39558	Ø35 x 30mm Essence Jar, Bergeon Swiss	EACH	£25.95
E39559	Ø60 x 35mm Essence Jar, Bergeon Swiss	EACH	£37.95
E39560	Ø80 x 35mm Essence Jar, Bergeon Swiss	EACH	£53.65

Essence Jars, Bergeon Swiss with Metal Knob



- Bergeon 30513
- Cover with metal knob
- Multiple sizes available

Dimensions:

- Diameter Ø x Height

Code	Description	UOM	Price
E0529	Ø60 x 50mm Essence Jar, Bergeon Swiss	EACH	£58.95
E0531	Ø100 x 55mm Essence Jar, Bergeon Swiss	EACH	£84.50

Essence Jars, Swisotech



- Swisotec
- Cover with glass knob (may vary)
- Perfectly ground lid and jar ensuring near zero evaporation
- Multiple sizes available
- Made in Switzerland

Dimensions:

- Diameter Ø x Height

Code	Description	UOM	Price
B44198	Ø50 x 40mm Essence Jar, Swisotech	EACH	£25.95
B44199	Ø80 x 30mm Essence Jar, Swisotech	EACH	£31.50

Essence Jars, Plastic



- Plastic
- Ø70mm
- Height 40mm
- Cover with knob
- Inexpensive if lost or damaged
- Made in India

Code	Description	UOM	Price
B39343	Ø70mm Essene Jar, Indian	EACH	£1.95

Diamond & Gemstone Washing Cup



Diamond & gemstone washing cups are the perfect way to clean your precious stones in alcohol or any cleaning solution without the fear of losing them.

- Separate, removable sieve compartment prevents stones from swirling loose in cleaning solution
- Glass jars with screw on lids
- Small or large

G39601:

- Overall size - Ø60 x 65mm
- Cleaning basket - Ø40 x 50mm
- Weight - 300g

G39600:

- Overall size - Ø90 x 110mm
- Cleaning basket - Ø70 x 95mm
- Weight - 600g

Code	Description	UOM	Price
G39601	Ø60mm Diamond & Gemstone Washing Cup	EACH	£6.20
G39600	Ø90mm Diamond & Gemstone Washing Cup	EACH	£10.95

EYEGLASSES, LOUPES, MICROSCOPES, OPTIVISORS ETC.

BINOCULAR MAGNIFIERS

Perhaps you know the problem all too well... You need to use both hands when you're working with delicate components and could do with a third hand to hold the magnifying glass so that you can see the small details. With our binocular magnifiers you can keep both hands free because these magnifying spectacles are worn just like normal glasses.

Ideal for:

- Jewellery making/repair
- Watch maker's services and repair
- Model making
- Handicrafts
- Reading
- Painting
- Restoration work
- Soldering
- Testing/inspection work
- Beauticians

A*F Swiss Binocular Magnifiers



A*F Swiss

Excellent value magnifiers for spectacle wearers, comfortable in use thanks to their light weight and excellent quality optics. The hinged lens plate and supporting arm are freely adjustable for observing the object without eye strain. The spring clip fits practically all types of spectacle frames.

- A*F 176.582
- Focal length 4"
- Magnification x2.5

Code	Description	UOM	Price
E0540	Binocular Magifier Clip On	EACH	£18.25

Light Tec Binocular Magnifiers



Light Tec

- Lightweight design
- 3 different strength lenses: x1.5, x2.5 & x3.5
- LED bulb for giving you the perfect work environment

Code	Description	UOM	Price
G35669	Binocular Magnifiers with L.E.D	EACH	£6.95

Light Tec, Superior Binocular Magnifiers



Light Tec - Superior

- Sturdy frame design
- 5 different strength lenses: x1, x1.5, x2, x2.5 & x3.5
- Lenses are 85 x 30mm
- 2 removable LED bulbs for giving you the perfect work environment
- Elastic headband option which can replace the frame arms for a different feel

Code	Description	UOM	Price
G37240	Binocular Magnifiers with L.E.D Light - 5 Lens	EACH	£15.95

Eschenbach Max Detail Binocular Magnifiers



Eschenbach - Germany

Optics Max Detail - the glasses for demanding, detailed work. Made in Germany For 20 years the Eschenbach Optic group has developed and produced customer specific high precision polymer lenses and silicone optics. Made with ultra-precision machining and modern precision moulding machines in a temperature controlled

production environment, the Eschenbach Optic group offers its customers optics at the highest quality standards.

Features:

- Very simple to use due to large PD tolerance range
- Supplied with attachable temple ends which prevent the spectacles from slipping down the nose
- Excellent image quality due to large focusing range
- Also suitable for spectacle wearers as they have right and left dioptre compensation which can be separately adjusted
- Adjustable temples: Temples with metal wire inserts - to allow the temple to be shaped to provide a good fit

Technical information:

- Magnification 2.0 x
- Weight: 49g
- PD tolerance range 60 - 68 mm (PD = pupillary distance, the distance between your pupils)
- Distance of use: Approx. 40cm
- Visual field 10°, 15 cm / 40 cm
- Dioptre compensation: ±3.0 dpt, right/left can be separately adjusted, cylinder correction is not possible
- The manufacturer states that the universal fitting and moulding of these glasses to the individuals head is achieved by pressing in the middle of the arms once the glasses are on your head. This ensures that they will universally fit to any individuals head.

Code	Description	UOM	Price
O35293	Binocular Mganifiers, Adjustable Lens	EACH	£74.95

EYEGLASS HOLDERS

Eyeglass Holder, Indian



- Steel band Plastic coated
- Moveable into any position
- Adjustable to any eye glass

Code	Description	UOM	Price
E31912	Eyeglass Holder, Indian	EACH	£1.95

Eyeglass Holder, Bergeon 5461



- Stainless steel wire
- Economical version of Bergeon 2405 (E0567)
- Adjustable to any eye glass.

Code	Description	UOM	Price
E0568	Eyeglass Holder, Bergeon 5461	EACH	£3.45

EYEGLASS WATCHMAKERS LOUPES

Watchmakers Loupes, USA

Donegan - Made in USA

- Convenient hands free magnification for spectacle wearers
- Graduated positional cams secure to glasses frame arm, with lens swivelling away when not needed
- Converts to left or right eye and includes



- fixing instructions
- Choice of strengths
- Made in USA

Specifications:

- Single or double lens
- Mag x2.8, x4, x12

No.2 1/2 (Mag x4) Loupe



Donegan - Made in USA
 • No.2 1/2 (Mag x4) Loupe
 • Single lens

Code	Description	UOM	Price
E9605	No.2 1/2 (Mag x4) Loupe	EACH	£24.95

No.3 1/2 (Mag x2.8) Loupe



Donegan - Made in USA
 • No.3 1/2 (Mag x2.8) Loupe
 • Single lens

Code	Description	UOM	Price
E9606	No.3 1/2 (Mag x2.8) Loupe	EACH	£24.95

Double Lens (Mag x12) Loupe



Donegan - Made in USA
 • This double lens version can give x12 mag combined
 • First lens x 5, second lens x 7
 • Made in USA.

Code	Description	UOM	Price
E9607	Double Lens (Mag x12) Loupe	EACH	£28.95

Watchmakers Loupes, Cousins



- Universal for left or right eye fitting

- Traditional Watchmakers Clip On Loupe

Code	Description	UOM	Price
E34945	No.2 (Mag x5) Eyeglass	EACH	£2.95
E34946	No.2.5 (Mag x4) Eyeglass	EACH	£2.95
E34947	No.3 (Mag x3.5) Eyeglass	EACH	£2.95
E34948	No.3.5 (Mag x3) Eyeglass	EACH	£2.95
E34949	No.4 (Mag x2.5) Eyeglass	EACH	£2.95

Watchmakers Loupes, Cousins - Double



- Universal for left or right eye fitting
- Traditional watchmakers clip on double loupe
- x3.3 & x5 magnification

Code	Description	UOM	Price
E39437	3.3x & 5x Eyeglass	EACH	£3.95

EYEGLASSES - CLIP ON SPECTACLES

- Size 1.0" (1) - Magnification 10x actual - eye to object 1" inch (25mm)
- Size 1.5" (1 1/2) - Magnification 6.7x actual - eye to object 1 1/2" inch (38mm)
- Size 2.0" (1) - Magnification 5x actual - eye to object 2" inch (51mm)
- Size 2.5" (1 1/2) - Magnification 4x actual - eye to object 2 1/2" inch (64mm)
- Size 3.0" (1) - Magnification 3.3x actual - eye to object 3" inch (76mm)
- Size 3.5" (1 1/2) - Magnification 2.8x actual - eye to object 3 1/2" inch (89mm)
- Size 4.0" (1) - Magnification 2.5x actual - eye to object 4" inch (102mm)

Example: Bergeon 2611-2.0" eyeglass will provide 5 x magnification at 2" (51mm) distance

ARY, Left Eye Clip On

- Sleeved spring clip cleverly holds to spectacle frame with lens in path of vision - pivots away when not needed
- Eyeglass for spectacles, ARY - STANDARD
- Bergeon 1492G
- Horotec MSA00.100G
- Extra light
- Easily adjustable to any frame. Contact parts are covered with rubber, 4 holding clamps
- Centring adjustment
- With screw ring
- Number is the focal length in inches



Code	Description	UOM	Price
E0537	No.1 (Mag x10) Eyeglass, Left	EACH	£53.95
E0538	No.1.5 (Mag x6.7) Eyeglass, Left	EACH	£53.95
E7311	No.2 (Mag x5) Eyeglass, Left	EACH	£53.95
E7312	No.2.5 (Mag x4) Eyeglass, Left	EACH	£53.95
E7313	No.3 (Mag x3.3) Eyeglass, Left	EACH	£53.95
E7314	No.3.5 (Mag x2.8) Eyeglass, Left	EACH	£53.95
E7315	No.4 (Mag x2.5) Eyeglass, Left	EACH	£53.95

ARY, Right Eye Clip On

- Sleeved spring clip cleverly holds to spectacle frame with lens in path of vision - pivots away when not needed.
- Eyeglass for spectacles, ARY - STANDARD
- Bergeon 1492D
- Horotec MSA00.100D
- Extra light
- Easily adjustable to any frame. Contact parts are covered with rubber, 4 holding clamps.
- Centring adjustment.
- With screw ring.



Code	Description	UOM	Price
E0535	No.1 (Mag x10) Eyeglass, Right	EACH	£53.95
E0536	No.1.5 (Mag x6.7) Eyeglass, Right	EACH	£53.95
E7306	No.2 (Mag x5) Eyeglass, Right	EACH	£53.95
E7307	No.2.5 (Mag x4) Eyeglass, Right	EACH	£53.95
E7308	No.3 (Mag x3.3) Eyeglass, Right	EACH	£53.95
E7309	No.3.5 (Mag x2.8) Eyeglass, Right	EACH	£53.95
E7310	No.4 (Mag x2.5) Eyeglass, Right	EACH	£53.95

ARY, Right Eye Clip On (large frames)

- For large spectacle frames
- Eyeglass for spectacles, ARY - MAXI
- Bergeon 6223D
- Horotec MSA00.103D
- Extra light
- Easily adjustable to any frame.
- Contact parts are covered with rubber, 4 holding clamps.
- Centring adjustment.
- With screw ring.



Code	Description	UOM	Price
E7316	No.3 (Mag x3.3) Eyeglass, Right	EACH	£59.95

ARY Eyeglass Spare Parts



By adding this simple press fit multiplier lens the magnification of an Ary will be boosted by 6 1/2 times.

- Bergeon 5664 - Swiss Made
- 6.5x magnification
- For either left or right eyeglasses

Also available are replacement lenses and spring clips.

Code	Description	UOM	Price
E0539	ARY Additional Eyeglass	EACH	£13.95
E7317A	ARY 1.5 Lens (x6.7)	EACH	£14.95
E7317B	ARY Eyeglass Replacement 3.0 Lens	EACH	£14.95
E8781	ARY Spring Clip, Right Hand	EACH	£41.50
E20012	ARY Spring Clip, Left Hand	EACH	£41.50



Cousins Clip On



- Universal for left or right eye fitting
- Choice of 5 different strengths

Code	Description	UOM	Price
E34940	No.2 (Mag x5) Eyeglass	EACH	£2.95
E34941	No.2.5 (Mag x4) Eyeglass	EACH	£2.95
E34942	No.3 (Mag x3.3) Eyeglass	EACH	£2.95
E34943	No.3.5 (Mag x2.8) Eyeglass	EACH	£2.95
E34944	No.4 (Mag x2.5) Eyeglass	EACH	£2.95

Cousins, Clip On (Anodised)



- Universal for left or right eye fitting
- Metal anodised
- Ø23mm diameter lens
- Far East

Code	Description	UOM	Price
E36693	Mag x4 Anodised Eyeglass	EACH	£7.95
E35127	Mag x15 Anodised Eyeglass	EACH	£7.95

EYEGASSES - DOUBLE LENS

Double Lens Eyeglasses for extra strong close up viewing of items with high magnification x10, x12, x15 & x20

- Bergeon
- Cousins
- Seitz

Bergeon Double Lens Eyeglasses

Bergeon 1458A-12 & 1458A-15
 • Swiss Made
 • x12 & X15 Magnification
 • Extra strong eyeglass for close and high magnification.



Code	Description	UOM	Price
E0559	Double Lens x12 Magnification, Bergeon	EACH	£10.85
E0560	Double Lens x15 Magnification, Bergeon	EACH	£11.50

Cousins Double Lens Eyeglasses

Cousins Swiss Style
 • x12, x15 & x20 Magnification
 • Twin lens inspection loupes



Code	Description	UOM	Price
E9227	Double Lens x12 Magnification, Cousins	EACH	£1.95
E9228	Double Lens x15 Magnification, Cousins	EACH	£1.95
E39431	Double Lens x20 Magnification, Cousins	EACH	£1.50

EYEGASSES - REGULAR

- Size 1.0" (1) - Magnification 10x actual - eye to object 1" inch (25mm)
- Size 1.5" (1½) - Magnification 6.7x actual - eye to object 1½" inch (38mm)
- Size 2.0" (1) - Magnification 5x actual - eye to object 2" inch (51mm)
- Size 2.5" (1½) - Magnification 4x actual - eye to object 2½" inch (64mm)
- Size 3.0" (1) - Magnification 3.3x actual - eye to object 3" inch (76mm)
- Size 3.5" (1½) - Magnification 2.8x actual - eye to object 3½" inch (89mm)
- Size 4.0" (1) - Magnification 2.5x actual - eye to object 4" inch (102mm)

Example: Bergeon 2611-2.0" eyeglass will provide 5 x magnification at 2" (51mm) distance

A*F Swiss, Standard

Eyeglasses - A*F Swiss

Range of excellent quality watchmakers eyeglasses. Top quality, distortion-free glass lenses. Nicely finished body in light black plastic. Lens retaining ring unscrews for easy cleaning of the lens.



- A*F Swiss
- Loupes for watchmakers
- "Mag" = Magnification

- Mineral glass lens

Code	Description	UOM	Price
E34909	No.1.5 (Mag x6.7) Eyeglass	EACH	£6.75
E34910	No.2 (Mag x5) Eyeglass	EACH	£6.75
E34911	No.2.5 (Mag x4) Eyeglass	EACH	£6.75
E34912	No.3 (Mag x3.3) Eyeglass	EACH	£6.75
E34913	No.3.5 (Mag x2.8) Eyeglass	EACH	£6.75
E34914	No.4.0 (Mag x2.5) Eyeglass	EACH	£6.75

Bergeon, Standard

Eyeglasses - Bergeon Swiss

- Bergeon 4422
- High quality loupes with lens retained by internal ring
- "Mag" = Magnification
- Mineral glass lens



Code	Description	UOM	Price
E0561	No.1.5 (Mag x6.7) Eyeglass	EACH	£7.40
E0562	No.2 (Mag x5) Eyeglass	EACH	£7.40
E7323	No.2.5 (Mag x4) Eyeglass	EACH	£7.40
E5012	No.3 (Mag x3.3) Eyeglass	EACH	£7.40
E7324	No.3.5 (Mag x2.8) Eyeglass	EACH	£7.40
E5013	No.4 (Mag x2.5) Eyeglass	EACH	£7.40

Bergeon, Aplanatic

Eyeglasses - Bergeon Swiss - Aplanatic

- Bergeon 4902
- Optically / Spectrally corrected for jewellers seeking minimum aberration
- "Mag" = Magnification
- Mineral glass lens



Code	Description	UOM	Price
E0563	No.1 (Mag x10) Aplanatic Eyeglass	EACH	£27.75
E0565	No.1.5 (Mag x6.7) Aplanatic Eyeglass	EACH	£27.75
E0564	No.2 (Mag x5) Aplanatic Eyeglass	EACH	£27.75
E7325	No.2.5 (Mag x4) Aplanatic Eyeglass	EACH	£27.75
E7326	No.3 (Mag x3.3) Aplanatic Eyeglass	EACH	£27.75
E7327	No.4 (Mag x2.5) Aplanatic Eyeglass	EACH	£27.75

Bergeon, Screw Rimmed



Eyeglasses - Bergeon Swiss - Screw Rimmed

- Bergeon 2611-N & 2611-B
- Black or white
- High quality loupe
- Easily removable lens for cleaning with external screw rim
- "Mag" = Magnification



• Mineral glass lens

Code	Description	UOM	Price
E2869	Black, No.1.5 (Mag x6.7) Eyeglass	EACH	£10.95
E2870	Black, No.2 (Mag x5) Eyeglass	EACH	£10.95
E2871	Black, No.2.5 (Mag x4) Eyeglass	EACH	£10.95
E2872	Black, No.3 (Mag x3.3) Eyeglass	EACH	£10.95
E2873	Black, No.3.5 (Mag x2.8) Eyeglass	EACH	£10.95
E2874	Black, No.4 (Mag x2.5) Eyeglass	EACH	£10.95
E40502	White, No.1.5 (Mag x6.7) Eyeglass	EACH	£10.95
E40503	White, No.2 (Mag x5) Eyeglass	EACH	£10.95
E40504	White, No.2.5 (Mag x4) Eyeglass	EACH	£10.95
E40505	White, No.3 (Mag x3.3) Eyeglass	EACH	£10.95
E40506	White, No.3.5 (Mag x2.8) Eyeglass	EACH	£10.95
E40507	White, No.4 (Mag x2.5) Eyeglass	EACH	£10.95

Bergeon, Sight Opening



Eyeglasses - Bergeon Swiss - Sight Opening

- Bergeon 2611-TN & 2611-TB
- Black or white
- Sight opening allows natural light into the viewing space
- High quality loupe
- Easily removable lens for cleaning with external screw rim
- "Mag" = Magnification
- Mineral glass lens

Code	Description	UOM	Price
E40490	Black, No.1.5 (Mag x6.7) Eyeglass	EACH	£13.50
E40491	Black, No.2 (Mag x5) Eyeglass	EACH	£13.50
E40492	Black, No.2.5 (Mag x4) Eyeglass	EACH	£13.50
E40493	Black, No.3 (Mag x3.3) Eyeglass	EACH	£13.50
E40494	Black, No.3.5 (Mag x2.8) Eyeglass	EACH	£13.50
E40495	Black, No.4 (Mag x2.5) Eyeglass	EACH	£13.50
E40496	White, No.1.5 (Mag x6.7) Eyeglass	EACH	£13.50
E40497	White, No.2 (Mag x5) Eyeglass	EACH	£13.50
E40498	White, No.2.5 (Mag x4) Eyeglass	EACH	£13.50
E40499	White, No.3 (Mag x3.3) Eyeglass	EACH	£13.50
E40500	White, No.3.5 (Mag x2.8) Eyeglass	EACH	£13.50
E40501	White, No.4 (Mag x2.5) Eyeglass	EACH	£13.50

Cousins, Standard

Eyeglasses - Cousins

- General purpose
- Ground glass lens
- Comfortable plastic body
- Inexpensive to replace if lost or damaged
- "Mag" = Magnification
- Mineral glass lens



Set contains:
• 2.5x - 3x - 5x - 7x - 10x

Code	Description	UOM	Price
E39432	Eyeglass Set	PACK*5	£3.95
E36244	No.1 (Mag x10) Eyeglass	EACH	£0.95
E36245	No.1.5 (Mag x6.7) Eyeglass	EACH	£0.95
E36246	No.2 (Mag x5) Eyeglass	EACH	£0.95
E36247	No.2.5 (Mag x4) Eyeglass	EACH	£0.95
E36248	No.3 (Mag x3.5) Eyeglass	EACH	£0.95
E8904	No.3.5 (Mag x2.8) Eyeglass	EACH	£0.95

E36250	No.4 (Mag x2.5) Eyeglass	EACH	£0.95
--------	--------------------------	------	-------

Price breaks available, see website

Cousins, Aluminium

Eyeglasses - Cousins - Aluminium

- General purpose
- Inexpensive to replace if lost or damaged
- Cool Aluminium body
- "Mag" = Magnification
- Mineral glass lens



Code	Description	UOM	Price
E34926	No. 1 (Mag x10) Eyeglass	EACH	£1.15
E34927	No.1.5 (Mag x6.7) Eyeglass	EACH	£1.15
E34928	No.2 (Mag x5) Eyeglass	EACH	£1.15
E34929	No. 2.5 (Mag x 4) Eyeglass	EACH	£1.15
E34930	No.3 (Mag x3.5) Eyeglass	EACH	£1.15
E34931	No. 3.5 (Mag x2.8) Eyeglass	EACH	£1.15
E34932	No. 4 (Mag x2.5) Eyeglass	EACH	£1.15

Cousins, Anodised Aluminium

Eyeglasses - Cousins - Anodised

- Inexpensive Swiss Alternative
- Classic Shape
- Aluminium Screw Rim
- "Mag" = Magnification
- Mineral glass lens



Code	Description	UOM	Price
E35124	Mag x3 Anodised Eyeglass	EACH	£8.50
E36694	Mag x4 Anodised Eyeglass	EACH	£8.50
E35125	Mag x5 Anodised Eyeglass	EACH	£8.50
E35126	Mag x10 Anodised Eyeglass	EACH	£8.50

Cousins, Anodised Aluminium with Sight Opening

Eyeglasses - Cousins - Anodised Aluminium

- Anodised Aluminium
- Sight opening allows natural light into the viewing space
- Rolex pepsi style screw rim
- Sapphire glass lens
- Classic Shape
- "Mag" = Magnification



Code	Description	UOM	Price
E53121	Mag x3 Anodised Eyeglass	EACH	£9.95
E53122	Mag x4 Anodised Eyeglass	EACH	£9.95
E53123	Mag x5 Anodised Eyeglass	EACH	£9.95
E53124	Mag x10 Anodised Eyeglass	EACH	£9.95
E53125	Mag x15 Anodised Eyeglass	EACH	£9.95

Cousins, Collapsible



Eyeglasses - Cousins - Collapsible

- General purpose
- Inexpensive to replace if lost or damaged
- Collapsible, easy to transport
- Supplied in plastic carry case
- Ø23mm lens
- Collapses to Ø38 x 11mm
- Colours may vary
- Mineral glass lens

Code	Description	UOM	Price
E39433	2x Collapsible Eyeglass	EACH	£1.75
E39434	2.5x Collapsible Eyeglass	EACH	£1.75
E39435	3x Collapsible Eyeglass	EACH	£1.75
E39436	3.5x Collapsible Eyeglass	EACH	£1.75

Cousins, LED

Eyeglasses - Cousins - with LED

- 6x, 10x or 15x magnification
- General purpose
- Inexpensive to replace if lost or damaged
- With white LED light
- Ø20mm lens
- Mineral glass lens



Code	Description	UOM	Price
E40254	6x Eyeglass with LED	EACH	£2.25
E40255	10x Eyeglass with LED	EACH	£2.25
E39430	15x Eyeglass with LED	EACH	£2.95

Cousins, Screw Rimmed

Eyeglasses - Cousins - Screw Rimmed

- General purpose
- Inexpensive to replace if lost or damaged
- Comfortable plastic body
- Easily removable lens for cleaning with external aluminium style screw rim
- Mineral glass lens
- Mineral glass lens



Code	Description	UOM	Price
E34933	No.1 (Mag x10) Eyeglass	EACH	£1.45
E34934	No.1.5 (Mag x6.7) Eyeglass	EACH	£1.45
E34935	No.2 (Mag x5) Eyeglass	EACH	£1.45
E34936	No.2.5 (Mag x4) Eyeglass	EACH	£1.45
E34937	No.3 (Mag x3.5) Eyeglass	EACH	£1.45
E34938	No.3.5 (Mag x2.8) Eyeglass	EACH	£1.45
E34939	No.4 (Mag x2.5) Eyeglass	EACH	£1.45

Online Discounts

Diamond & Gemstone Scoops

See Page 1011



Cousins, with Plastic Headband



Eyeglasses - Cousins - with Headband

- General purpose
- Inexpensive to replace if lost or damaged
- Comfortable plastic body
- Supplied with plastic headband
- Headband consists of high tension wire with a plastic coating for extra comfort
- Mineral glass lens

Code	Description	UOM	Price
E45821	X5 Eyeglass with Headband	EACH	£2.25
E45822	X10 Eyeglass with Headband	EACH	£2.25

Cousins, Wood



Eyeglasses - Cousins - Wood

- Rose Wood
- Steam Beech
- Ø18.5mm Lens
- Smooth & quality finish
- Stylish & unusual
- Unbeatable value
- "Mag" = Magnification
- Mineral glass lens

Code	Description	UOM	Price
E37145	No.1.5 (Mag x7) Rosewood	EACH	£5.95
E37146	No.2 (Mag x5) Rosewood	EACH	£5.95
E37147	No.2.5 (Mag x4) Rosewood	EACH	£5.95
E37148	No.3 (Mag x3.5) Rosewood	EACH	£5.95
E37149	No.3.5 (Mag x3) Rosewood	EACH	£5.95
E37150	No.4 (Mag x2.5) Rosewood	EACH	£5.95
E37151	No.4.5 (Mag x2) Rosewood	EACH	£5.95
E37152	No.1 (Mag x10) Steam Beech	EACH	£5.95
E37153	No.1.5 (Mag x7) Steam Beech	EACH	£5.95
E37154	No.2 (Mag x5) Steam Beech	EACH	£5.95
E37155	No.2.5 (Mag x4) Steam Beech	EACH	£5.95
E37156	No.3 (Mag x3.5) Steam Beech	EACH	£5.95
E37157	No.3.5 (Mag x3) Steam Beech	EACH	£5.95
E37158	No.4 (Mag x2.5) Steam Beech	EACH	£5.95
E37159	No.4.5 (Mag x2) Steam Beech	EACH	£5.95

Horotec, Anodised Aluminium

Eyeglasses - Horotec Swiss - Anodised Aluminium

- Anodised aluminium body & rim
- Lens Ø25mm
- Screw Rim
- Very Robust
- Mineral glass lens
- "Mag" = Magnification
- Horotec 00.031.X



Code	Description	UOM	Price
E31464	No. 1 (Mag x10) Eyeglass	EACH	£38.95
E31465	No. 1.5 (Mag x6.7) Eyeglass	EACH	£38.95
E31466	No. 2 (Mag x5) Eyeglass	EACH	£38.95
E31467	No. 2.5 (Mag x4) Eyeglass	EACH	£38.95
E31468	No. 3 (Mag x3.5) Eyeglass	EACH	£38.95
E31469	No. 3.5 (Mag x3) Eyeglass	EACH	£38.95
E31470	No. 4 (Mag x2.5) Eyeglass	EACH	£38.95

Horotec, Plastic with Anodised Aluminium Ring

Eyeglasses - Horotec Swiss - Plastic - Aluminium Ring

- Black plastic body with anodised aluminium screw ring
- Lens Ø22mm
- Screw Rim
- Very Robust
- Mineral glass lens
- "Mag" = Magnification
- Horotec 00.032.X



Code	Description	UOM	Price
E31471	No. 1 (Mag x10) Eyeglass	EACH	£25.95
E31472	No. 1.5 (Mag x6.7) Eyeglass	EACH	£25.95
E31473	No. 2 (Mag x5) Eyeglass	EACH	£25.95
E31474	No. 2.5 (Mag x4) Eyeglass	EACH	£25.95
E31475	No. 3 (Mag x3.5) Eyeglass	EACH	£25.95
E31476	No. 3.5 (Mag x3) Eyeglass	EACH	£25.95
E31477	No. 4 (Mag x2.5) Eyeglass	EACH	£25.95

Horotec, Wood



Eyeglasses - Horotec Swiss - Wooden

- Horotec Swiss
- Box Wood
- Cherry Wood
- Pear Wood
- Platane Wood
- "Mag" = Magnification
- Mineral glass lens

All with Screw Bezel & Removable Ø22mm Lens

Code	Description	UOM	Price
E31526	Box Wood No. 1 (Mag x10)	EACH	£56.95
E31527	Box Wood No. 1.5 (Mag x6.7)	EACH	£56.95
E31528	Box Wood No. 2 (Mag x5.0)	EACH	£56.95
E31530	Box Wood No. 3 (Mag x3.5)	EACH	£56.95
E31531	Box Wood No. 3.5 (Mag x3.0)	EACH	£56.95
E31532	Box Wood No. 4 (Mag x2.5)	EACH	£56.95
E31519	Cherry Wood No. 1 (Mag x10)	EACH	£43.95
E31520	Cherry Wood No. 1.5 (Mag x6.7)	EACH	£43.95

E31521	Cherry Wood No. 2 (Mag x5.0)	EACH	£43.95
E31522	Cherry Wood No. 2.5 (Mag x4.0)	EACH	£43.95
E31524	Cherry Wood No. 3.5 (Mag x3.0)	EACH	£43.95
E31525	Cherry Wood No. 4 (Mag x2.5)	EACH	£43.95
E31512	Pear Wood No. 1 (Mag x10)	EACH	£61.95
E31513	Pear Wood No. 1.5 (Mag x6.7)	EACH	£61.95
E31514	Pear Wood No. 2 (Mag x5.0)	EACH	£61.95
E31515	Pear Wood No. 2.5 (Mag x4.0)	EACH	£61.95
E31516	Pear Wood No. 3 (Mag x3.5)	EACH	£61.95
E31517	Pear Wood No. 3.5 (Mag x3.0)	EACH	£61.95
E31518	Pear Wood No. 4 (Mag x2.5)	EACH	£61.95
E31533	Platane Wood No. 1 (Mag x10)	EACH	£61.95
E31534	Platane Wood No. 1.5 (Mag x6.7)	EACH	£61.95
E31535	Platane Wood No. 2 (Mag x5.0)	EACH	£61.95
E31536	Platane Wood No. 2.5 (Mag x4.0)	EACH	£61.95
E31537	Platane Wood No. 3 (Mag x3.5)	EACH	£61.95
E31538	Platane Wood No. 3.5 (Mag x3.0)	EACH	£61.95
E31539	Platane Wood No. 4 (Mag x2.5)	EACH	£61.95

LINEN MAGNIFIERS

Linen Magnifiers



A hands free magnifier with a built in measuring scale and stand

For viewing and measuring small watch parts, jewels, stones, threads & even bar codes

- Excellent for viewing small parts
- Hands free
- Folds away for easy storage and transportation
- Sit in your workbench or counter top
- Great for customers to view rings, earrings & precious stones
- Sturdy metal frame
- x8 or x10
- Supplied in plastic pouch

Strength x Viewing Cut Out. See additional information for full specification.

Code	Description	UOM	Price
E39442	x8 Linen Magnifier (12 x 12mm)	EACH	£3.95
E39441	x10 Linen Magnifier (25 x 15mm)	EACH	£3.95

Linen Magnifiers, Eschenbach



Eschenbach - Made in Germany

A hands free magnifier with a built in stand.

PRICE PROMISE
GUARANTEE



For viewing and measuring small watch parts, jewels, stones, threads & even bar codes.

- Stylish satin chrome finish
- Solid brass construction
- Fine quality, ground biconvex lens
- Excellent for viewing small parts
- Hands free
- Folds away for easy storage and transportation
- x5, x6, x8 & x10
- Cousins made in Germany
- Eschenbach made in Germany

Strength x Viewing Cut Out. See additional information for full specification.

Code	Description	UOM	Price
L40269	x5 Linen Magnifier (30 x 30mm)	EACH	£35.50
L40270	x6 Linen Magnifier (25 x 25mm)	EACH	£30.60
L49484	x8 Linen Magnifier (20 x 20mm), Cousins	EACH	£16.95
L40272	x10 Linen Magnifier (15 x 15mm)	EACH	£27.15

Linen Magnifiers, Plastic

VALUE



A hands free magnifier with a built in measuring scale and stand

For viewing and measuring small watch parts, jewels, stones, threads & even bar codes

- Built in millimetre scale
- Excellent for viewing small parts
- Hands free
- Folds away for easy storage and transportation
- Plastic, lightweight frame
- x5, x7 or x10

Strength x Viewing Cut Out. See additional information for full specification.

Code	Description	UOM	Price
E39445	x5 Linen Magnifier (25 x 25mm)	EACH	£4.25
E39444	x7 Linen Magnifier (15 x 15mm)	EACH	£3.95
E39443	x10 Linen Magnifier (15 x 15mm)	EACH	£3.50

LOUPE TRIPLETS & LOUPE CHAINS

Cousins presents a large selection of loupes, triplets and loupe chains.

Our range of robust pocket loupes is popular in a wide range of professions and hobbyists, including jewellery, precious metal hallmark viewing, coin inspection, gemmology, geology, printing, stamp collectors etc.

Triplet loupes are considered the very best of hand magnification technology compared to contemporary eye pieces because they are specifically manufactured with three lenses which are knitted together. Their combination eliminates most of the optical distortion from

the outer edge of the lens, giving a colour corrected image.

Additionally available are loupes with achromatic and aplanatic lenses. These specially treated lenses are corrected for spherical aberrations and colour distortion, giving the user a perfect view of the object every time.

- Powerful precision glass lens brings fine micro-detail into view
- Made with the finest quality optics and with top quality metal cases
- All supplied with leather storage cases
- Available in brass or steel and in different size lenses
- See our PDF for a magnification vs focal length overview

Small loupes are easy to carry and very good to view fine items such as hallmarks. Larger loupes are excellent to view larger items giving a broader all round view.

How to use an Eye Loupe:

1. Bring the loupe up to your eye as close as is comfortable and definitely without touching your eyeball.
2. This is not a contact lense so keep the loupe absolutely stationary and close to your eye, do not move the loupe.
3. There shouldn't be room for an object between your eye and the loupe. If there is, then get the loupe closer. Brushing against your eyelashes or your glasses is a good indicator that you've got it close enough.
4. Be sure to keep both eyes open. It is natural to want to close the other eye but eventually it leads to eye strain more quickly than keeping both eyes open.

Harald Schneider Loupe

Harald Schneider Diamond Loupes - The Ultimate in Optical Performance

The ORIGINAL-SCHNEIDER-LOUPE © is an especially manufactured product with international reputation. For years it has been approved as the best loupe for diamond graduation worldwide. Since 1976, Harald Schneider have been manufacturing this product, with sales across the globe. Quite a large number of copies & fakes exist, but none come near to the very special high-end lens system. Many try, but none reach the high quality of the ORIGINAL-SCHNEIDER-LOUPE ©.

- Schneider diamond loupes: Standard, L1 & L2
- Achromatic & aplanatic
- Ø18 or Ø20mm lens
- x10 Magnification
- Improved lens system which provides total clarity and more depth
- Sharp, clear edge to edge distortion free viewing
- Harald Schneider branded loupe rope included
- Comes with protective leather carry case
- Often cited as "the best loupe in the world"
- See "more info" for specifications

PRICE PROMISE GUARANTEE

Standard Harald Schneider Loupe



- x10 magnification
- Ø18mm lens
- Achromatic & aplanatic
- Harald Schneider "Standard"

Code	Description	UOM	Price
E52793	Standard Harald Schneider Loupe	EACH	£149.95

L1 Harald Schneider Loupe



- x10 magnification
- Ø20mm lens
- Achromatic & aplanatic
- Harald Schneider "L1"

Code	Description	UOM	Price
E52794	L1 Harald Schneider Loupe	EACH	£199.95

L2 Harald Schneider Loupe



- x10 magnification
- Ø20mm lens
- Achromatic & aplanatic
- Superior lenses give the best resolution in the industry
- Better depth of focus than any other loupe
- Harald Schneider "L2"

Code	Description	UOM	Price
E44195	L2 Harald Schneider Loupe	EACH	£235.00